

**Stevens Institute of Technology**

**The New Jersey Toxics Reduction Workplan  
for NY-NJ Harbor**

**Ambient Monitoring of Water Quality  
within Major Tributaries & the Estuary**

**Studies I-D and I-E**

**Final Report – April 2007**

## EXECUTIVE SUMMARY

The presence of toxic chemicals in the water and sediments of New York-New Jersey Harbor has resulted in reduced water quality, fisheries restrictions/advisories, reproductive impairments in some species, and general adverse impacts to the estuarine and coastal ecosystems. In addition, problems associated with the management of contaminated dredged material have resulted in uncertainty regarding planned construction and future maintenance of the maritime infrastructure that supports shipping in the harbor.

The New Jersey Toxics Reduction Workplan for NY-NJ Harbor (NJTRWP) includes a series of studies designed to provide the NJ Department of Environmental Protection with the information it needs to identify sources of the toxic chemicals of concern, and to prioritize these sources for appropriate action. The primary goal of the water quality components of NJTRWP Studies I-D and I-E (undertaken by Stevens Institute of Technology) is to determine the relative importance of the discharges of selected organic and inorganic toxic contaminants originating within the watersheds of the major New Jersey tributaries to the harbor.

Study I-D of the NJTRWP involved the collection and analysis of water samples in the tidal portions of the major New Jersey tributaries to the harbor – the Passaic, Hackensack, Elizabeth, Rahway, and Raritan Rivers. Sampling was also undertaken in the estuarine areas of Newark Bay, the Arthur Kill, and the Kill van Kull under NJTRWP Study I-E. State-of-the-art sampling and analytical procedures were used to determine the concentrations of metals (Cd, Pb, Hg, and methyl-Hg), PCBs, dioxins/furans, pesticides, and PAHs in the water column. Sampling was conducted from June 2000 to May 2002 at ten (10) fixed sampling sites located on the banks of the tributary rivers, and five (5) ship-board locations in the estuarine areas of the harbor (Figure 1). Sampling targeted defined dry weather/low river flow and wet weather/high river flow hydrologic conditions in the tributaries. This is by far the most comprehensive sampling for toxic contaminants ever to occur in this economically important and complex estuarine system.

Water quality sampling was performed using the Stevens Modified Trace Organics Platform Sampler (SIT-TOPS). The advantage of the SIT-TOPS is its ability to process large volumes of water, and thus obtain large samples of both the dissolved and suspended sediment fractions in the water column. Combined with high-resolution analytical methods, this allows for the consistent detection of trace levels of the toxic contaminants.

**Metals:** Grab samples were collected and analyzed for total and dissolved cadmium (Cd), lead (Pb), mercury (Hg), and methyl-Hg.

- **Cadmium - no sample collected as part of this study exceeded either the NJ Saline Aquatic Chronic Water Quality Criteria (WQC) for dissolved Cd (8,800 ng/L) or the Human Health WQC for Total Cd (16,000 ng/L).**

Mean dissolved Cd concentrations were similar at all of the sampling stations (range = 40.5 to 109.7 ng/L), except for a lower mean concentration in the upper Raritan River (Station RAR2 = 21.7 ng/L). Mean concentrations of Total Cd were also similar at most of the sampling stations (range = 76.1 to 155.3 ng/L), and was also lower in the upper Raritan River

(Station RAR2 = 39.7 ng/L). The high mean percentage of dissolved Cd in the samples (68.4%) probably accounts for the comparable levels of this metal throughout the study area.

Dissolved Cd concentration did not vary with river flow conditions (i.e. wet/dry weather) at any of the sampling stations. Total Cd and suspended sediment Cd concentrations also did not vary with river flow; except in the Elizabeth and Rahway Rivers, where they tended to be greater during wet weather events.

- **Lead - no sample collected as part of this study exceeded the NJ Saline Aquatic Chronic WQC for dissolved Pb (24,000 ng/L).**

Mean Total Pb at the sampling stations varied by a factor of 5 (range = 1,722 to 10,898 ng/L), and mean dissolved Pb (range = 177 to 1,566 ng/L) varied by a factor of 9. The highest mean Total Pb concentrations (>6,000 ng/L) were measured in the tributaries, particularly in the Rahway and Elizabeth Rivers, the upper Hackensack River (Station HAC3), and in the mid/upper Passaic River (Stations PAS2 and PAS3). Most of the Pb was found in the suspended sediment fraction (mean = 82.6%), and there was a strong correlation between Total Pb (ng/L) and suspended sediment (mg/L).

Dissolved Pb concentrations did not vary with river flow conditions (i.e. wet/dry weather) at any of the sampling stations. Total Pb and suspended sediment Pb concentrations also did not vary with river flow; except perhaps in the Rahway River, where they tended to be greater during wet weather events.

- **Mercury – The NJ Saline Human Health WQC for Total Hg (51 ng/L) was exceeded by the mean concentration in the lower/mid Passaic River (Stations PAS1 and PAS2a), mid/upper Hackensack River (Stations HAC2 and HAC3), and in the Rahway River, and by individual samples at other locations. No sample collected as part of this study exceeded the NJ Saline Aquatic Chronic WQC for dissolved Hg (940 ng/L).**

Mean Total Hg (range = 9.5 to 190.8 ng/L) and dissolved Hg (range = 0.31 to 6.37 ng/L) at each of the sampling stations varied by a factor of 20 throughout the harbor. Mean Total Hg concentrations were highest in the Hackensack, Rahway, and Passaic Rivers, with the lowest values in the Raritan River and at the surface estuarine stations. Most of the Hg was found in the suspended sediment fraction (mean = 93.5%), but there was only a moderate correlation between Total Hg and suspended sediment (mg/L) in the harbor.

Dissolved Hg concentrations did not vary with river flow conditions (i.e. wet/dry weather) at any of the sampling stations. Total Hg and suspended sediment Hg concentrations also did not vary with river flow; except in the Rahway River, where they tended to be greater during wet weather events.

- **methyl-Hg** - concentrations generally followed the pattern of Total Hg, with higher concentrations measured in the Hackensack River (particularly at Station HAC3) and the Rahway River.

**The results of the metals sampling program indicate that, compared to the applicable NJ WQC, Cd and Pb do not appear to have significant adverse impacts on overall water quality in the study area, while Hg is having significant impacts.** Concentrations of these metals do not appear to vary in response to changing river flow conditions (i.e. dry/wet weather), except in the Rahway River. The increases in the Total and suspended sediment concentrations of these metals during high flow/wet weather events in the Rahway River are indicative of potential stormwater/runoff sources.

**PCBs:** SIT-TOPS were used to collect dissolved and suspended sediment samples that were analyzed for 114 of the 209 PCB congeners.

**The NJ Saline Human Health WQC for Total PCBs (64 pg/L) was exceeded by every sample collected as part of this study. The NJ Saline Aquatic Chronic WQC (30 ng/L) for Total PCBs was exceeded by the mean concentration only in the Rahway River, and by individual samples in the Elizabeth, Passaic, and upper Hackensack Rivers.**

There was little variation (factor of 4) in the mean Total Dissolved PCB concentrations throughout the study area (range = 1,461 to 5,517 pg/L). However, mean Total Dissolved PCBs tended to be lower in the Raritan River and lower Arthur Kill (range = 1,461 to 2,175 pg/L) compared with the other stations (range = 2,825 to 5,517 pg/L).

Mean Total Suspended Sediment PCB concentrations (pg/L) were highest in the Rahway River (51,219 pg/L), Passaic River (13,066 to 24,224 pg/L), Elizabeth River (20,982 pg/L), and mid/upper Hackensack River (11,362 to 19,188 pg/L). Mean Total Suspended Sediment PCBs were lower (< 10,000 pg/L) at the Raritan River and estuarine stations.

Mean Total Suspended Sediment PCB concentrations (ng/g sed) were highest in the Elizabeth (2,166 ng/g sed) and Rahway (1,500 ng/g sed) Rivers, and lowest in the Raritan River (310 to 476 ng/g sed). Mean concentrations were similar at the other sampling stations (range = 596 to 921 ng/g sed).

Total PCB suspended sediment concentrations (pg/L) did not vary with river flow conditions; except in the Rahway River, where they tended to be greater during wet weather events. In contrast, there was a tendency for the mean Total Suspended Sediment PCB concentrations (ng/g sed) in the tributaries to be greater during the dry weather conditions.

- PCB Homolog Distribution Patterns – PCB congeners can be divided into ten homolog groups, based upon their degree of chlorination (Mono- through Deca-). The percentage of the total mass resulting from each homolog group can be calculated for each sample, and homolog distribution patterns developed. These patterns can potentially be used to identify sources of the PCBs.

On average, in the NJTRWP samples 95% of the total dissolved PCB mass was distributed among the Mono- through Penta- homolog groups, with 70% of the mass concentrated in the

Tri- and Tetra- homologs. In contrast, on average 92% of the total suspended sediment PCB mass was distributed among the Tri- through Hepta- homologs, with the maximum mass in the Tetra- and Penta- groups (combined 51%).

There was little variability in the PCB homolog distribution patterns within each site, as well as among the sites, in the Passaic River, Hackensack River, and Newark Bay. There was also little variability in the PCB homolog distribution patterns in Newark Bay, the Kill van Kull, and Arthur Kill. In addition, there were no consistent differences in the homolog distribution patterns between the wet and dry weather surveys in these waterbodies. However, there do appear to have been some consistent differences/trends that may be indicative of potential PCB sources and/or suspended sediment and contaminant transport in the harbor.

In contrast, the PCB homolog distribution patterns in the Rahway, Elizabeth, and Raritan Rivers, and the upper Arthur Kill, varied among the surveys, particularly for the suspended sediment fraction data. There were no consistent differences in the homolog distribution patterns between the wet and dry weather surveys in these water bodies. PCB homolog distribution patterns in both the dissolved and suspended sediment phases showed that the Elizabeth and Rahway River sampling stations tended to shift towards the higher (Penta-through Hepta-) homolog groups compared with the Passaic and Hackensack Rivers. This trend may be indicative of different PCB sources.

**The widespread exceedances of the applicable NJ State Water Quality Criteria indicate that PCBs have significant adverse impacts on water quality in the study area.** Trends in the PCB homolog distribution patterns throughout the study area may be indicative of different PCB sources and/or sediment/contaminant transport mechanisms.

**Dioxins/Furans (PCDD/Fs):** SIT-TOPS were used to collect suspended sediment samples that were analyzed for the seventeen (17) 2,3,7,8-substituted poly-chlorinated dibenzodioxin/furan congeners. Due to the very low solubility of PCDD/Fs, dissolved fraction samples were not collected.

**The NJ Saline Aquatic Human Health WQC for 2,3,7,8-TCDD (0.0051 pg/L) was exceeded by every sample collected in this study (except for a few samples where 2,3,7,8-TCDD was not detected).**

Mean Total Dioxin/Furan (tPCDD/F) concentrations (pg/L) were largely determined by the Total PCDD concentrations, and were highest in the Rahway (665 pg/L) and Elizabeth (362 pg/L) Rivers. Mean concentrations were >200 pg/L in the lower Passaic River (Station PAS1), upper Raritan River (Station RAR2), and upper Hackensack River (Station HAC3). Mean tPCDD/F concentrations were less than 160 pg/L at the other sampling stations. Over all sampling stations and sampling events, there was a moderate correlation between tPCDD/F (pg/L) and suspended sediment (mg/L).

The highest mean 2,3,7,8-TCDD concentration (pg/L) was found at the lower Passaic River Station PAS1 (7.29 pg/L), with elevated concentrations at Stations PAS2 (4.67 pg/L) and PAS3

(4.45 pg/L). Mean 2,3,7,8-TCDD concentrations were also high in upper Newark Bay and the Hackensack River (0.96 to 1.97 pg/L) compared to the remaining stations (less than 0.60 pg/L).

The highest mean Total PCDD/F concentrations (ng/g sed) were found in the Elizabeth River (30.4 ng/g sed) and at Station RAR2 (34.1 ng/g sed). Elevated mean tPCDD/F concentrations (>11 ng/g sed) were observed in the Rahway River, lower Arthur Kill, and in the lower Raritan River. Mean tPCDD/F concentrations were less than 10 ng/g sed at the remaining stations, and showed little variability within the Passaic and Hackensack Rivers, Newark Bay, and the upper Arthur Kill.

The highest mean 2,3,7,8-TCDD concentrations (pg/g sed) were found in the lower Passaic River (Station PAS1 = 279 pg/g sed), with elevated levels in the mid/upper Passaic River (Stations PAS2/3; 141 to 201 pg/g sed), upper Newark Bay (Stations NB1-S/D; 83 to 98 pg/g sed) and the mid/lower Hackensack River (Stations HAC1/2 = 77 to 114 pg/g sed). In addition, elevated levels of 2,3,7,8-TCDD were also found in the Elizabeth River (65.8 pg/g sed). Mean 2,3,7,8-TCDD levels were less than 35 pg/g sed at the remaining stations.

Overall, approximately 77% of the tPCDD/F is OCDD. The elevated mean tPCDD/F concentrations at Station RAR2 are largely the result of consistently very high OCDD concentrations that accounted for 95.4% of the mean tPCDD/F at this station.

- PCDD/F Toxicity – 2,3,7,8-TCDD is one of the most toxic compounds known, and has been assigned a Toxic Equivalency Factor (TEF) of 1. The toxicity of the other sixteen (16) PCDD/F congeners relative to 2,3,7,8-TCDD has been determined, with TEFs ranging between 0.0001 and 1.

The highest total toxicities (TEQ) were measured in the Passaic River (mean = 179 to 343 pg TEF/g sed) and were largely due to high 2,3,7,8-TCDD concentrations (mean = 141 to 279 pg/g sed) that accounted for, on average, 68% to 79% of the TEQ in these samples. Total TEQ levels were also elevated in upper Newark Bay and the mid/lower Hackensack River. The higher tPCDD/F TEQs at these stations were due to a combination of higher 2,3,7,8-TCDD concentrations (47 to 60% of the TEQ) and elevated concentrations of 2,3,4,7,8-PeCDF and 1,2,3,4,7,8-HxCDF (8 to 17% of the TEQ).

Total TEQ was also high in the Elizabeth River as a result of very high tPCDD/F concentrations. On average, 2,3,7,8-TCDD accounted for 28% of the tPCDD/F TEQ, with 2,3,4,7,8-PeCDF, 1,2,3,7,8-PeCDD, and 1,2,3,4,6,7,8-HpCDD each accounting for 10% to 12% of the TEQ.

Mean tPCDD/F TEQ were less than 90 pg TEF/g sed at the remaining stations, with the lowest mean levels (~50 pg TEF/g sed or less) in lower Newark Bay, the Kill van Kull, and the Raritan River. The Raritan River samples differed from the other areas of the harbor, with 2,3,7,8-TCDD accounting for only a small percentage of the tPCDD/F TEQ.

- 2,3,7,8-TCDD - The most toxic of the PCDD/F congeners is 2,3,7,8-TCDD (TEF = 1). Over all sampling stations, ~44% of the tPCDD/F TEQ was the result of 2,3,7,8-TCDD, with a range among the sampling stations of 7% to 79%. The highest concentrations of 2,3,7,8-TCDD (as well as %TEQ resulting from 2,3,7,8-TCDD) were found in the Passaic and Hackensack Rivers, and upper Newark Bay. 2,3,7,8-TCDD concentrations were variable at each of these stations, but the highest concentrations were usually found at the lower Passaic River Station PAS1. There did not appear to be any consistent dry-wet weather pattern in the 2,3,7,8-TCDD concentrations at these stations; except at Station PAS3, where during dry weather 2,3,7,8-TCDD accounted for 76% to 85% of the tPCDD/F TEQ, and during the wet weather events it was not detected or accounted for only 42% of the tPCDD/F TEQ.

The 2,3,7,8-TCDD concentration distribution pattern among the sampling sites in Newark Bay and the Passaic and Hackensack Rivers points to the existence of a source(s) along the Passaic River, probably between stations PAS1 and PAS2. The major source of this 2,3,7,8-TCDD has been attributed to the Diamond Alkali (Lister Avenue, Newark) site located on the banks of the lower Passaic River.

- PCDD/F Congener Distribution Patterns – Analogous to the PCB homolog distribution patterns, the percentage of the total mass resulting from each dioxin/furan congener can be calculated for each sample, and congener distribution patterns developed. These patterns can potentially be used to identify sources of the dioxins/furans.

The furan (PCDF) distribution pattern was more variable among the sites than the dioxin distribution pattern (except for 2,3,7,8-TCDD). Thus, for source identification purposes, 2,3,7,8-TCDD and the furans will be most useful.

The OCDD congener dominated all stations (69 to 95% of the mean total PCDD/F concentration at each station) but there was no consistent background OCDD concentration (mean =  $9,122 \pm 8,707$  pg/g sed).

The highest 2,3,7,8-TCDD concentrations were observed at the lower Passaic River Station PAS1, and there was very little variability in the PCDD/F congener distribution patterns for each sampling event at this station. This is indicative of a single source of dioxins/furans.

In contrast, the PCDD/F congener distribution patterns were more variable among the sampling events in the Elizabeth River. The lower chlorinated PCDD/Fs (tetra through hexa, including 2,3,7,8-TCDD) consistently comprised a higher percentage of the tPCDD/Fs during the dry weather surveys compared with the wet weather surveys. This indicated at least two different sources of PCDD/Fs to the lower Elizabeth River.

Compared to the other stations, the mid/lower Hackensack River sampling stations (HAC1 and HAC2) showed a higher mean percentage of tPCDF (31% to 35% of the total PCDD/F concentration). This was primarily due to higher mean percentages of OCDF (16-18%), 1,2,3,4,6,7,8-HpCDF (10-11%), and 1,2,3,4,7,8-HxCDF (3%). A similar mean pattern in these furan congeners (21% to 25% tPCDF) was found at Stations HAC3, NB1-S/D, and PAS1. This may be indicative of a dioxin/furan source along the lower Hackensack River.

**The widespread exceedances of the NJ Saline Human Health WQC for 2,3,7,8-TCDD indicates that dioxins/furans (in the form of 2,3,7,8-TCDD) have significant adverse impacts on water quality in the study area.**

Based on tPCDD/F and 2,3,7,8-TCDD concentrations and tPCDD/F TEQs, it appears that the harbor estuary can be separated into five sub-areas, as follows:

- Passaic River, Upper Newark Bay, and the Hackensack River: characterized by elevated levels of 2,3,7,8-TCDD (particularly in the lower Passaic River) and high tPCDD/F TEQs.
- Elizabeth River: characterized by elevated levels of tPCDD/Fs and 2,3,7,8-TCDD, resulting in a high mean tPCDD/F TEQ.
- Rahway River: characterized by very high levels of tPCDD/Fs and elevated levels of 2,3,7,8-TCDD. However, the mean tPCDD/F TEQ is not elevated.
- Raritan River: the upper Raritan River is characterized by elevated levels of tPCDD/Fs due to very high concentrations of OCDD. PCDD/F concentrations in the lower Raritan River are similar to those in the lower Arthur Kill. 2,3,7,8-TCDD concentrations are low. Total PCDD/F TEQ at both sites were among the lowest in the harbor.
- Arthur Kill, Kill Van Kull, and Lower Newark Bay: characterized by low to moderate levels of tPCDD/Fs and low levels of 2,3,7,8-TCDD. Total PCDD/F TEQ are low at these sites.

Analysis of the PCDD/F congener distribution patterns have identified potential sources of PCDD/Fs to NY-NJ Harbor associated with the following locations:

- Lower Passaic River (and upper Newark Bay and lower Hackensack River): 2,3,7,8-TCDD.
- Lower Hackensack River: PCDFs, particularly OCDF, 1,2,3,4,6,7,8-HpCDF, and 1,2,3,4,7,8-HxCDF.
- Elizabeth River (at least 2 different sources): tetra- through hexa- PCDD/Fs, including 2,3,7,8-TCDD.
- Upper Raritan River: OCDD.

**PAHs:** SIT-TOPS were used to collect suspended sediment samples, and filtered grab samples were collected for dissolved fraction PAH analyses. These samples were analyzed for 24 individual PAH compounds, and total C2 and C3 alkyl-naphthalenes.

**The NJ Saline Human Health WQC for benzo(a)pyrene (18 ng/L) was exceeded at all of the sampling locations in the tidal Passaic, Hackensack, Elizabeth, and Rahway Rivers, and at sampling Stations NB1-S and AK1-S. The NJ Saline Human Health WQC for dibenz(a,h)anthracene (18 ng/L) was exceeded by the mean concentration in the Rahway River.**

Some of the dissolved phase PAH target analytes were impacted by blank contamination to a substantial degree (including naphthalene, the various methyl-naphthalene compounds, and the



C2 and C3 alkyl-naphthalenes). Thus, the use of the data for these analytes, as well as the calculation of total PAH concentrations (dissolved only; dissolved + suspended sediment fractions), is problematical. Minimal blank contamination impacts were found for the TOPS Filter (suspended sediment) samples.

The highest mean Total dissolved PAH concentrations were measured in the Rahway (1,388 ng/L) and Elizabeth (1,099 ng/L) Rivers.

Elevated mean suspended sediment Total PAH levels (> 20,000 ng/g sed and 200 ng/L) were found in the Elizabeth River, at all three Passaic River stations, in the lower Hackensack River, in the Rahway River, and in the upper Arthur Kill.

On average 60% of the total PAHs were in the dissolved phase (although this percentage is actually higher because of the blank contamination impacts on the dissolved fraction data). The highest total PAH concentrations (> 1,300 ng/L; suspended sediment + dissolved fractions) were measured in the Rahway River, the Elizabeth River, the upper Hackensack River, and the mid-Passaic River. Even though ~60% of the Total PAHs were found in the dissolved phase, there was a moderate correlation between total PAHs (ng/L) and SS (mg/L).

- PAH Source Identification - Parent and alkyl-substituted PAHs have both natural sources (coal, oil seeps, forest and prairie fires) and anthropogenic sources (fossil fuels and combustion). Ratios of the concentrations of various individual PAH compounds can potentially be used to identify the types of sources for the PAHs found in environmental samples. Based on the NJTRWP sample data, combustion of petroleum and gas/wood/coal is the main source of PAHs to the harbor; this is to be expected for this urbanized region.

**Pesticides:** SIT-TOPS were used to collect dissolved and suspended sediment samples that were analyzed for 27 organochlorine pesticides. Those pesticides of concern identified by the NY-NJ Harbor Toxics Work Group – DDT and metabolites, Chlordane, Dieldrin (as well as BHC - including Lindane) – were evaluated in detail by the NJTRWP.

The highest mean Total dissolved pesticide concentration was measured in the Rahway River (7.92 ng/L). The lowest concentrations were in lower Newark Bay (1.28 ng/L), the Kill van Kull (1.59 ng/L), and the southern Arthur Kill (Station PA-D = 1.68 ng/L). Along the rivers with more than one sampling station along their tidal stretches (the Passaic, Hackensack, and Raritan Rivers), there was a tendency for the Total dissolved pesticide concentration to increase in the upstream direction.

The highest mean suspended sediment Total pesticide concentrations were measured in the Rahway (1,213 ng/g sed) and Elizabeth (1,384 ng/g sed) Rivers, with intermediate levels in the upper Passaic River (Station PAS3 = 743 ng/g) and Arthur Kill (565 – 950 ng/g). Lower mean levels (120 – 315 ng/g) are found at all of the other stations.

- DDT & metabolites - **The NJ Saline Human Health WQC for Total 4,4'-DDD (suspended + dissolved fractions; 0.31 ng/L) was exceeded by 91% of the samples**

**collected as part of this study. The NJ Saline Human Health WQC for Total 4,4'-DDE and Total 4,4'-DDT (0.22 ng/L) was exceeded by 93% and 47%, respectively, of the samples. The NJ Saline Aquatic Chronic WQC for Total 4,4'-DDT (1.0 ng/L) was exceeded by 21% of the samples, including all/most of the samples in the lower Passaic River, Elizabeth River, Rahway River, and upper Arthur Kill.**

Total DDT (and metabolite) concentrations are calculated by adding the concentrations of 2,4'-DDD, 2,4'-DDE, 2,4'-DDT, 4,4'-DDD, 4,4'-DDE, and 4,4'-DDT. Note that the dissolved fraction (TOPS XAD) samples were frequently impacted by blank contamination for 2,4'-DDT (31 of 69 samples). The highest mean dissolved Total DDT concentrations were measured in the Rahway River (3.21 ng/L) and northern Arthur Kill (1.88 to 3.33 ng/L). Mean concentrations were less than 0.90 ng/L at all of the other stations. Along the rivers with more than one sampling station along their tidal stretches (the Passaic, Hackensack, and Raritan Rivers), there was a tendency for the mean dissolved Total DDT concentration to decrease in the upstream direction; this is opposite of what was observed for total dissolved pesticides.

The highest mean suspended sediment Total DDT concentrations were measured in the Rahway (936 ng/g) and Elizabeth (734 ng/g) Rivers, with intermediate levels in the upper Passaic River (Station PAS3 = 382 ng/g) and Arthur Kill (465 to 680 ng/g). Lower mean levels (50 to 210 ng/g) were found at all of the other stations.

- **Total Chlordane - The NJ Saline Human Health WQC for Total Chlordane (suspended + dissolved fractions; 0.11 ng/L) was exceeded by every sample collected as part of this study. The New Jersey Saline Aquatic Chronic WQC for Total Chlordane (4.0 ng/L) was exceeded by the mean concentrations in the Rahway and Elizabeth Rivers, and by individual samples at Stations PAS1 and PAS3.**

The Total Chlordane concentrations are calculated by adding the concentrations of trans-nonachlor, cis-nonachlor, oxy-Chlordane, alpha-Chlordane, and gamma-Chlordane. The highest mean dissolved Total Chlordane concentrations were measured in the Rahway River (1.62 ng/L), in the mid/upper-Passaic River (1.04 to 1.31 ng/L), and in the Elizabeth River (0.98 ng/L). Mean concentrations at all of the other sampling stations were less than 0.75 ng/L. Along the rivers with more than one sampling station along their tidal stretches (the Passaic, Hackensack, and Raritan Rivers), there was a tendency for the Total dissolved Chlordane concentration to increase in the upstream direction.

The highest mean suspended sediment Total Chlordane concentration was measured in the Elizabeth River (482 ng/g sed), with mean concentrations in the Rahway River and upper Passaic River greater than 175 ng/g sed. Mean concentrations at all of the other stations were less than 100 ng/g sed.

- **Dieldrin – The NJ Saline Human Health WQC for Total Dieldrin (suspended + dissolved fractions; 0.054 ng/L) was exceeded by almost every sample collected as part**

**of this study. The NJ Saline Aquatic Chronic WQC for Total Dieldrin (1.9 ng/L) was exceeded by only two (2) samples.**

The highest mean dissolved Dieldrin concentrations were measured in the Rahway River (0.87 ng/L), and the mid/upper Passaic River (0.69 to 1.08 ng/L). Mean concentrations at all of the other sampling stations were less than 0.51 ng/L. Along the rivers with more than one sampling station along their tidal stretches (the Passaic, Hackensack, and Raritan Rivers), there was a tendency for the dissolved Dieldrin concentration to increase in the upstream direction.

The highest mean suspended sediment Dieldrin concentration was measured in the upper Passaic River (Station PAS3 = 94.3 ng/g), with elevated concentrations (> 30 ng/g) in the Rahway and Elizabeth Rivers. However, these mean values are elevated due to high values in only one sample collected at these stations. Mean suspended sediment Dieldrin concentrations at all other stations were less than 20 ng/g.

- **Total BHC – The NJ Saline Human Health and Aquatic Chronic WQC for alpha-, beta-, and gamma-BHC were not exceeded by any sample collected as part of this study.**

The Total BHC concentrations are calculated by adding the measured concentrations of alpha-BHC, beta-BHC, and gamma-BHC (Lindane). The highest mean concentrations were measured in the mid/upper Hackensack River (1.69 to 1.91 ng/L) and in the upper Arthur Kill (Station AK1-D = 1.88 ng/L).

**The widespread exceedances of the NJ Saline Human Health WQC by 4,4'-DDD/DDE/DDT, Total Chlordane, and Dieldrin indicate that these pesticides have significant adverse impacts on water quality in the study area.**

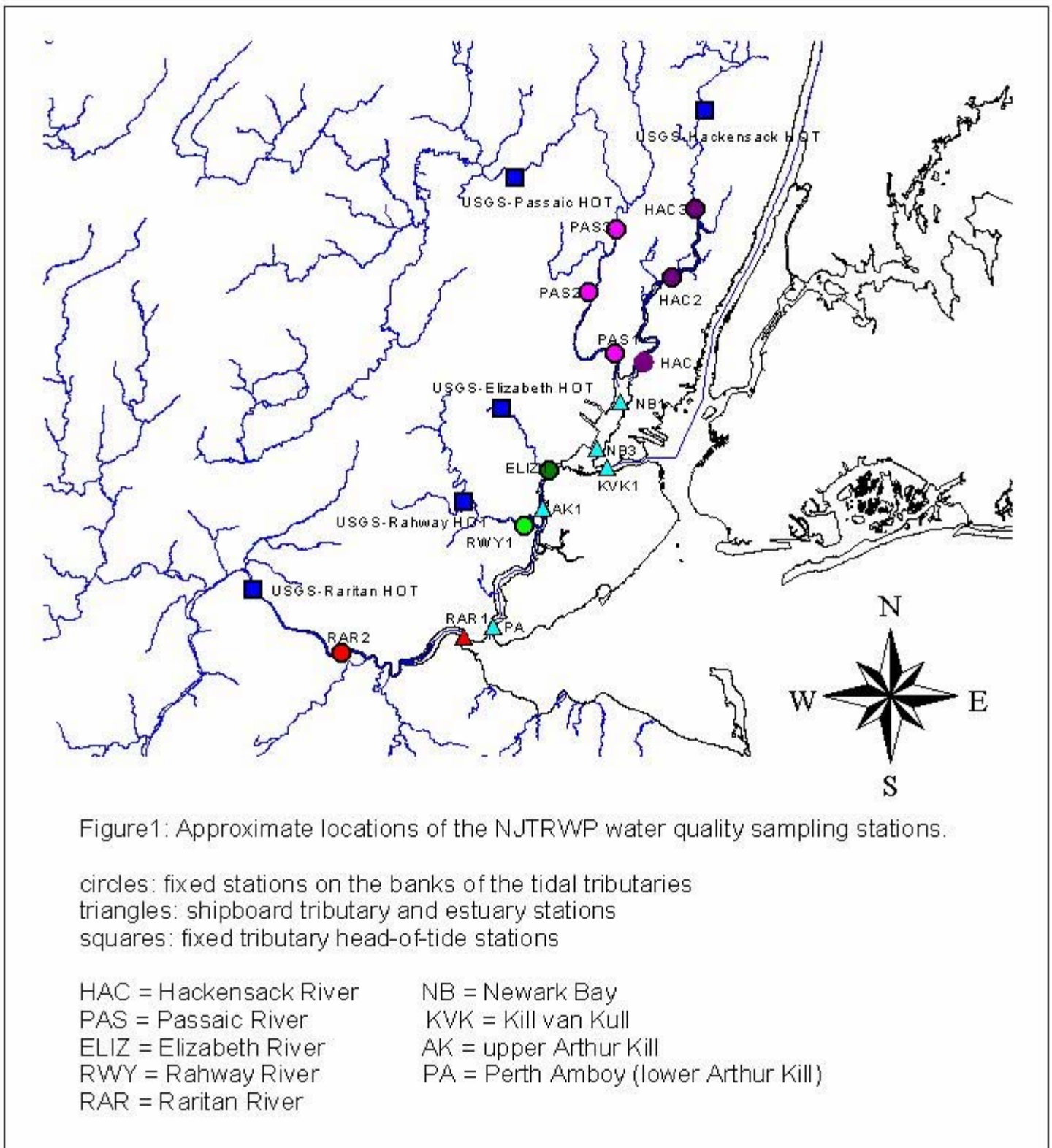
Mean concentrations of the various dissolved pesticides were elevated at particular sampling locations in the harbor, indicative of potential sources:

- Rahway River – Total pesticides, Total DDT & metabolites, Total Chlordane, and Dieldrin
- Upper Arthur Kill – Total Pesticides, Total DDT and metabolites, Total BHC
- mid/upper Passaic River (Stations PAS2 and PAS3) – Total Chlordane, Dieldrin
- Elizabeth River – Total Chlordane
- mid/upper Hackensack River (Stations HAC2 and HAC3) – Total BHC

Concentrations were lower and similar at the remaining sampling locations.

Along the Passaic, Hackensack, and Raritan Rivers, there was a tendency for dissolved pesticide concentrations (except Total DDT) to increase in the upstream direction, potentially indicative of upstream sources (with dilution occurring downstream).

The Rahway and Elizabeth Rivers had the highest mean suspended sediment Total pesticides, Total DDTs (and 4,4'-DDE and 4,4'-DDT), and Total Chlordane concentrations. Intermediate levels of these compounds were found in the upper Passaic River (Station PAS3) and Arthur Kill (Stations AK1-S/D and PA-S). The highest mean suspended sediment Dieldrin concentration was measured in the upper Passaic River (Station PAS3), with elevated concentrations in the Rahway and Elizabeth Rivers (although all of these Dieldrin means may be biased high due to one-time sample results).



# TABLE OF CONTENTS

<b>EXECUTIVE SUMMARY</b>	<b>2</b>
<b>1 – Introduction/Objectives</b>	<b>22</b>
<b>2 – Sampling Strategy</b>	<b>24</b>
2.1 Target Analytes	24
2.2 Sampling Locations	24
2.3 Sampling Schedule	28
2.4 Method for Riverbank Tributary Sampling Using SIT-TOPS	31
2.5 Shipboard Sampling Using SIT-TOPS	32
<b>3 - Sampling Procedures/Methodology</b>	<b>33</b>
3.1 Description of the SIT-TOPS	33
3.2 SIT-TOPS Operating Parameters	35
3.3 Sampling	35
<b>4 – Sample Analysis</b>	<b>38</b>
4.1 Laboratories Performing the Sample Analyses	38
4.2 Quality Assurance (QA) Program Overview	38
4.3 Data Analysis - Blank Correction Process	39
4.4 SS Removal using SIT-TOPS	40
4.5 POC Removal using SIT-TOPS	40
<b>5 – Results</b>	<b>43</b>
5.1 Suspended Solids (SS)	43
5.2 Dissolved Organic Carbon (DOC) and Particulate Organic Carbon (POC)	50
5.3 Metals	69
5.3.1 Sample Collection and Analysis	69
5.3.2 NJTRWP Blank Correction	69
5.3.3 Cadmium (Cd)	70
5.3.4 Lead (Pb)	83
5.3.5 Mercury (Hg)	95
5.3.6 Methyl Mercury (methyl-Hg)	104
5.3.7 Metals – Conclusions	106
5.4 PCBs	108
5.4.1 Sample Analysis	108
5.4.2 NJTRWP Blank Correction	108
5.4.3 Dissolved PCB Concentrations	109
5.4.4 Suspended Sediment PCB Concentrations	111
5.4.5 PCB Homolog Group Distribution Patterns	115
5.4.6 PCB – Conclusions	127

5.5 Dioxins-Furans	129
5.5.1 Sample Analysis	129
5.5.2 NJTRWP Blank Correction	129
5.5.3 Suspended Sediment PCDD/F Concentrations	129
5.5.4 PCDD/F Toxicity	139
5.5.5 PCDD/F Source Identification Based on Congener Distribution Patterns	144
5.5.6 Dioxins/Furans – Conclusions	148
5.6 PAHs	150
5.6.1 Sample Analysis	150
5.6.2 NJTRWP Blank Correction	150
5.6.3 Dissolved PAH Concentrations	154
5.6.4 Suspended Sediment PAH Concentrations	156
5.6.5 Total PAH Concentrations	157
5.6.6 Source Identification based on PAH Target Analyte Distribution	161
5.6.7 PAHs – Conclusions	163
5.7 Pesticides	164
5.7.1 Sample Analysis	164
5.7.2 NJTRWP Blank Correction	164
5.7.3 QA Issues	165
5.7.4 Dissolved Total Pesticides Concentrations	166
5.7.5 Suspended Sediment Total Pesticides Concentrations	177
5.7.6 Wet vs. Dry Events	185
5.7.7 Newark Bay: Surface vs. Bottom Concentrations	185
5.7.8 Pesticides - Conclusions	187
<b>6 – Summary and Conclusions</b>	<b>190</b>
<b>7 – Participants</b>	<b>195</b>
<b>8 – Acknowledgments</b>	<b>195</b>
<b>9 - Literature Cited</b>	<b>196</b>

## LIST OF FIGURES

Figure 1: Approximate Locations of the NJTRWP Water Quality Sampling Stations	25
Figure 2: Schematic Diagram of the Stevens Modified TOPS (SIT-TOPS)	34
Figure 3: Percentage removal of SS after the C-GFF (canister) filter	41
Figure 4: Percentage removal of SS after the C-GFF and inline flat filters	41
Figure 5: Percentage Removal of POC after the C-GFF (canister) filter	42
Figure 6: Percentage removal of POC after the C-GFF and inline flat filters	42
Figure 7: Overall Mean of the Geometric Mean SS (mg/L) concentrations at the SIT-TOPS Intake at each sampling station for each sampling event	46
Figure 8 (a-e): Geometric Mean SS Concentrations – Wet vs. Dry Sampling Events	47
Figure 9: Geometric Mean SS Concentrations at Stations NB001 and PA - Surface vs. Bottom samples	49
Figure 10: Overall Mean of the Geometric Mean DOC (mg/L) concentrations at the SIT-TOPS Intake at each sampling station for each sampling event (see Table 8)	56
Figure 11: Overall Mean of the Geometric Mean POC (mg/L) concentrations at the SIT-TOPS Intake at each sampling station for each sampling event (see Table 10).	57
Figure 12: Overall Mean of the Geometric Mean $f_{OC}$ ratio (mg C/g sed) at the SIT-TOPS Intake at each sampling station for each sampling event (see Table 11).	58
Figure 13 (a–e): Geometric Mean DOC Concentrations – Wet and Dry Sampling Events	60
Figure 14: Geometric Mean DOC Concentrations – Wet and Dry Sampling Events - at all of the sampling stations	62
Figure 15: Geometric Mean POC Concentrations and foc ratios – Wet and Dry Sampling Events. (a) Passaic River, (b) Hackensack River, (c) Newark Bay, (d) Rahway and Elizabeth Rivers, (e) Raritan River.	63
Figure 16: Geometric Mean POC Concentrations – Wet and Dry Sampling Events at all of the sampling stations.	65
Figure 17: Geometric Mean $f_{oc}$ ratios – Wet and Dry Sampling Events at all of the sampling stations	65
Figure 18: Geometric Mean DOC concentrations at Stations NB001 and PA - Surface vs. Bottom samples.	66
Figure 19: Geometric Mean POC concentrations at Stations NB001 and PA - Surface vs. Bottom samples.	67
Figure 20: Salinity Profiles at Station NB001 during the March 2001 sampling event.	67
Figure 21: Average Salinity Profile at Station NB001 in March 2001.	68
Figure 22: Average Salinity Profile at Station NB001 in October 2001.	68
Figure 23: Mean $\pm$ standard deviation of Total Cd concentration at each sampling station.	75



Figure 24: Mean $\pm$ standard deviation of dissolved Cd concentration at each sampling station.	75
Figure 25: Cd partitioning between the dissolved and suspended phases in the (a) Dec 2000, (b) Oct/Nov 2001, and (c) May 2001 sampling events.	76
Figure 26: Mean Total Cd concentration at each sampling station (ng/L).	77
Figure 27: Mean Dissolved Cd concentration at each sampling station (ng/L).	78
Figure 28(a-e): Dissolved Cd (ng/L), Total Cd (ng/L) and Suspended Sediment Cd (ng/g sed) Concentrations – Wet and Dry Sampling Events. (a) Passaic River, (b) Hackensack River, (c) Newark Bay, (d) Elizabeth and Rahway Rivers, (e) Raritan River.	79
Figure 29: Surface vs. Bottom Samples (a) Dissolved Cd, (b) Total Cd, and (c) Suspended Sediment Cd concentrations.	82
Figure 30: Mean $\pm$ standard deviation of the Total Pb concentration at each sampling station.	87
Figure 31: Mean $\pm$ standard deviation of dissolved Pb concentration at each sampling station.	87
Figure 32(a-e): Pb partitioning between the dissolved and suspended phases in the (a) Dec 2000, (b) March 2001, (c) October 2001 – Northern Tributaries, (d) May 2001, and (e) Oct/Nov 2001 – Southern Tributaries sampling events.	88
Figure 33: Mean Suspended Sediment Pb concentration at each station.	90
Figure 34(a-e): Dissolved Pb (ng/L), Total Pb, and Suspended Sediment Pb (ng/g sed) Concentrations – Wet and Dry Events. (a) Passaic River, (b) Hackensack River, (c) Newark Bay, (d) Rahway and Elizabeth Rivers, (e) Raritan River.	92
Figure 35: Surface vs. Bottom Samples (a) Dissolved Pb, (b) Total Pb, and (c) Suspended Sediment Pb concentrations.	95
Figure 36: Mean $\pm$ standard deviation of the Total Hg (ng/L) concentration at each sampling station.	100
Figure 37: Mean $\pm$ standard deviation of Suspended Sediment Hg (ng/g sed) concentration at each sampling station.	100
Figure 38: Mean Total Hg concentration at each sampling station (ng/L).	101
Figure 39: Mean Suspended Sediment Hg concentration at each station.	102
Figure 40(a-e): Total Hg and Suspended Sediment Hg Concentrations – Wet vs. Dry Events (a) Passaic River, (b) Hackensack River, (c) Newark Bay, (d) Rahway and Elizabeth Rivers, (e) Raritan River.	103
Figure 41: Mean $\pm$ standard deviation Total Dissolved PCB concentrations (pg/L) at each sampling station.	111
Figure 42: Mean $\pm$ standard deviation Total Suspended Sediment PCB concentrations (ng/g sed) at each sampling station.	114

Figure 43(a-p): Distribution of the PCB mass in the dissolved and suspended sediment phases among the PCB homolog groups at each sampling station for each sampling survey. (a) PAS1, (b) PAS2, (c) PAS3, (d) HAC1, (e) HAC2, (f) HAC3, (g) NB001-S, (h) NB001-D, (i) NB3, (j) RAR1, (k) RAR2, (l) RWY, (m) ELIZ1, (n) PA-S and PA-D, (o) AK1-S and AK1-D, (p) KVK.	116
Figure 44: Mean distribution of the Total Dissolved PCB mass among the homolog groups (a) Passaic and Hackensack Rivers, Newark Bay stations; (b) Newark Bay, Arthur Kill, and Kill van Kull stations.	123
Figure 45: Mean distribution of the Total Suspended Sediment PCB mass among the homolog groups (a) Passaic and Hackensack Rivers, Newark Bay stations; (b) Newark Bay, Arthur Kill, and Kill van Kull stations.	124
Figure 46: Distribution of PCB mass among the homolog groups for selected sampling surveys (April 2001, May 2001) in the Rahway and Elizabeth Rivers, and at Station AK1-D (a) dissolved PCBs, (b) suspended sediment PCBs.	125
Figure 47: Distribution of PCB mass among the homolog groups for selected sampling surveys (April 2001, May 2001) in the Raritan River, and the mean at Station PA-S (a) dissolved PCBs, (b) suspended sediment PCBs.	126
Figure 48: Mean ( $\pm$ one standard deviation) concentration tPCDDs and tPCDFs in the suspended sediment phase (ng/g sed) at every sampling station.	138
Figure 49: Mean concentration ( $\pm$ one standard deviation) of total PCDD/Fs with and without OCDD (tPCDD/F – OCDD) in the suspended sediment phase at every sampling station.	138
Figure 50: Mean $\pm$ one standard deviation of total PCDD/Fs and 2,3,7,8 TCDD toxicity (TEQ; pg TEF/g sed) at every sampling station.	143
Figure 51: 2,3,7,8-TCDD concentrations (pg/g sed) at selected sampling stations.	144
Figure 52: Mean PCDD/F congener distribution at each NJTRWP sampling station.	146
Figure 53: PCDD/F congener distribution patterns at selected sampling stations for all sampling events: (a) PAS1, and (b) ELIZ.	147
Figure 54: PCDD/F congener distribution pattern for sewage sludge, incinerator soil, and at sampling stations PAS1, PAS2, and ELIZ for selected dates.	148
Figure 55: Total mean concentration distributions of Total PAHs in the dissolved phase (ng/L) $\pm$ one standard deviation at every sampling station	156
Figure 56: Mean concentration $\pm$ one standard deviation of Total PAHs in the suspended sediment phase (ng/g) at every sampling station	160
Figure 57: Mean concentration $\pm$ one standard deviation of Total PAHs (dissolved + suspended sediment fractions; ng/L) at every sampling station	161
Figure 58: PAH cross plots for the ratio of An/(An+Phen) vs. Fl/(Fl+Py)	162
Figure 59: PAH cross plots for the ratio of IP/(IP+Bghi) vs. Fl/(Fl+Py)	162
Figure 60: Mean concentration $\pm$ one standard deviation dissolved Total pesticides (ng/L) at each sampling station.	167
Figure 61: Mean $\pm$ standard deviation dissolved Total DDT concentration (ng/L) at each sampling station.	169
Figure 62: Mean $\pm$ standard deviation dissolved 4,4'-DDD concentration (ng/L) at each sampling station.	170

Figure 63: Mean $\pm$ standard deviation dissolved 4,4'-DDE concentration (ng/L) at each sampling station.	170
Figure 64: Mean $\pm$ standard deviation dissolved 4,4'-DDT concentration (ng/L) at each sampling station.	171
Figure 65: Mean $\pm$ standard deviation dissolved Total Chlordane concentration (ng/L) at every sampling station.	173
Figure 66: Mean $\pm$ standard deviation dissolved Dieldrin concentration (ng/L) at each sampling station.	174
Figure 67: Mean $\pm$ standard deviation dissolved Total BHC concentration (ng/L) at every sampling station.	176
Figure 68: Mean $\pm$ standard deviation suspended sediment phase Total pesticide concentration (ng/g) at every sampling station.	178
Figure 69: Mean $\pm$ standard deviation suspended sediment Total DDT concentration (ng/g) at every sampling station.	179
Figure 70: Mean $\pm$ standard deviation suspended sediment 4,4'- DDE concentration (ng/g) at every sampling station.	180
Figure 71: Mean $\pm$ standard deviation suspended sediment 4,4'- DDE concentration (ng/g) at every sampling station.	181
Figure 72: Mean $\pm$ standard deviation suspended sediment Total Chlordane concentration (ng/g) at every sampling station.	182
Figure 73: Mean $\pm$ standard deviation suspended sediment Dieldrin concentration (ng/g) at every sampling station.	184
Figure 74: Dissolved and suspended sediment Total pesticides concentrations – Wet vs. Dry Events. (a) Passaic River, (b) Hackensack River, (c) Rahway, Elizabeth, and Raritan Rivers.	186
Figure 75: Surface vs. Bottom dissolved and suspended sediment Total pesticides concentrations at Newark Bay Station NB1-S/D.	187

## LIST OF TABLES

Table 1: Target Analyte List	26
Table 2: Water Quality Sampling Locations for NJTRWP Studies I-D and I-E	27
Table 3: Sampling Schedule	29
Table 4: Sampling Requirements for a SIT-TOPS 4-Hour Water Quality Sampling Run	37
Table 5: Geometric Mean SS Concentration (mg/L) at the SIT-TOPS Intake at each sampling station for each sampling event.	44
Table 6: Range of SS concentrations (mg/L) at the SIT-TOPS Intake at each sampling station during each sampling event.	45
Table 7: Range of DOC concentrations (mg/L) at the SIT-TOPS Intake at each sampling station during each sampling event.	51
Table 8: Geometric Mean DOC Concentration (mg/L) at the SIT-TOPS Intake at each sampling station for each sampling event.	52
Table 9: Range of POC concentrations (mg/L) at the SIT-TOPS Intake at each sampling station during each sampling event.	53
Table 10: Geometric Mean POC Concentration (mg/L) at the SIT-TOPS Intake at each sampling station for each sampling event.	54
Table 11: Geometric Mean $f_{oc}$ ratio(g C /g sed) at the SIT-TOPS Intake at each sampling station for each sampling event.	55
Table 12: NJTRWP Metals Analytical Methods and Method Detection Limits	69
Table 13: Number of NJTRWP SIT Ambient Water Quality Samples Censored as a Result of Blank Contamination Using the NJTRWP “5X Maximum Blank Approach”	70
Table 14: Dissolved Cd Concentration (ng/L)	71
Table 15: Total Cd Concentration (ng/L)	72
Table 16: Suspended Sediment Cd Concentration (ng/g sed)	74
Table 17: Total Pb Concentration (ng/L)	84
Table 18: Dissolved Pb Concentration (ng/L)	85
Table 19: Suspended Sediment Pb Concentration (ug/g sed)	86
Table 20: Total Hg Concentrations (ng/L)	97
Table 21: Dissolved Hg Concentrations (ng/L)	98
Table 22: Suspended Sediment Hg Concentration (ng/g sed)	99
Table 23: Total Methyl Hg Concentrations (ng/L)	105
Table 24: Dissolved Methyl Hg Concentration (ng/L)	106
Table 25: Total Dissolved PCB Concentration (pg/L)	110
Table 26: Total Suspended Sediment PCB Concentration (pg/L)	113
Table 27: Total Suspended Sediment PCB Concentration (ng/g sed)	114
Table 28: Total Suspended Sediment PCDD Concentration (pg/L)	133
Table 29: Total Suspended Sediment PCDD Concentration (pg/g sed)	134
Table 30: Total Suspended Sediment PCDF Concentrations (pg/L)	134
Table 31: Total Suspended Sediment PCDF Concentrations (pg/g sed)	135
Table 32: Total Suspended Sediment PCDD/F Concentrations (pg/L)	135
Table 33: Total Suspended Sediment PCDD/F Concentrations (pg/g sed)	136

Table 34: Total Suspended Sediment PCDD/F-OCDD Concentrations (pg/g sed)	136
Table 35: Total Suspended Sediment 2,3,7,8-TCDD Concentrations (pg/g sed)	137
Table 36: Total Suspended Sediment 2,3,7,8-TCDD Concentrations (pg/L)	137
Table 37: Total Toxicity (TEQ) from PCDDs (pg TEF/g sed)	141
Table 38: Total Toxicity (TEQ) from PCDFs (pg TEF/g sed)	142
Table 39: Total Toxicity (TEQ) from PCDD/Fs (pg TEF/g sed)	142
Table 40: Mean Group 1 Field, Method, and Equipment Blank Dissolved PAH Data	153
Table 41: Mean Group 2 Field, Method, and Equipment Blank Dissolved PAH Data	154
Table 42: Total Dissolved PAH Concentration (ng/L)	155
Table 43: Suspended Sediment Total PAH Concentration (ng/L)	159
Table 44: Suspended Sediment Total PAH Concentration (ng/g)	159
Table 45: Total PAH Concentration (ng/L)	160
Table 46: Number of Pesticide Samples Impacted by Blank Contamination	165
Table 47: Dissolved Total Pesticides Concentration (ng/L)	167
Table 48: Dissolved Total DDT Concentration (ng/L)	169
Table 49: Dissolved Total Chlordane Concentrations (ng/L)	172
Table 50: Dissolved Dieldrin Concentration (ng/L)	174
Table 51: Dissolved Total BHC Concentration (ng/L)	176
Table 52: Suspended Sediment Total Pesticides Concentration (ng/g)	177
Table 53: Suspended Sediment Total DDT Concentrations (ng/g)	179
Table 54: Suspended Sediment Total Chlordane Concentration (ng/g)	182
Table 55: Suspended Sediment Dieldrin Concentration (ng/g)	184

## **APPENDICES**

**APPENDIX A:** USGS River Flow Conditions

**APPENDIX B:** QA ISSUE: SIT Dissolved Metals Blank Contamination

**APPENDIX C:** QA ISSUE: SIT Phase I Dissolved Hg Data – Blank Contamination Impacts

**APPENDIX D:** Data Analysis SOP

**APPENDIX E:** NJTRWP SIT Water Grab Sample PAH Blanks

**APPENDIX F:** Data Integration – Water Quality and Hydrodynamics (August 17, 2006)

## 1 Introduction/Objectives

The New York-New Jersey Harbor estuary system is of enormous and interdependent ecological and economic importance. However, the presence of toxic chemicals in the water and sediments results in reduced water quality, fisheries restrictions/advisories, reproductive impairments in some species, and general adverse impacts to the estuarine and coastal ecosystems. The Port of New York and New Jersey is the largest port on the East Coast of the United States and central to the economy of the region. However, problems associated with the management of contaminated dredged material, including high costs and the lack of suitable disposal/use alternatives, have resulted in uncertainty regarding planned construction and future maintenance of the maritime infrastructure that supports shipping in the harbor.

The New Jersey Toxics Reduction Workplan for NY-NJ Harbor (NJTRWP) includes a series of studies designed to provide the NJ Department of Environmental Protection (NJDEP) with the data and information it needs to meet the following primary objectives:

- to identify sources of the toxic chemicals of concern, and to prioritize these sources for appropriate action (management, regulatory, trackdown, clean-up).
- to identify selected contaminated sediments for future remediation and restoration activities.

As part of the NJTRWP, Stevens Institute of Technology (SIT) conducted hydrodynamic and water and suspended sediment quality monitoring in the tidal reaches of the major New Jersey tributaries to the NY-NJ Harbor Estuary (Study I-D), and in the estuarine areas of Newark Bay, the Arthur Kill, and the Kill van Kull (Study I-E).

This Project Report documents the methods, results, analyses, and conclusions of the water and suspended sediment quality monitoring components of Studies I-D and I-E of the NJTRWP. These studies have provided the data and information needed to identify those areas within NY-NJ Harbor that are significant sources of the toxic chemicals of concern. The hydrodynamic components of these studies are presented and discussed in separate reports [Chant, 2006; Pence et al., 2006].

The primary goal of NJTRWP Studies I-D and I-E is to determine the relative importance of discharges of suspended sediment and selected organic and inorganic contaminants originating within the watersheds of the major tributaries to the Newark Bay Complex, the Arthur Kill, the Kill van Kull, and Raritan Bay. These discharges represent the loadings of sediment and the chemicals of concern from all sources that enter the tidal portions of these tributaries and estuarine areas.

The primary objectives of these studies are to:

- Identify those major tributaries which are significant sources of sediment and the chemicals of concern to NY-NJ Harbor;
- Develop baseline data which can be used for source trackdown activities and for monitoring of future remediation actions;
- Provide data for harbor modeling activities.

## 2 Sampling Strategy

### 2.1 Target Analytes

Table 1 lists the target analytes for this study.

### 2.2 Sampling Locations

The water quality sampling program (water and suspended sediment quality measurements using Trace Organics Platform Samplers [TOPS] and grab sampling devices) used ten (10) fixed sampling sites located on the banks of the tributary rivers, and five (5) ship-board locations in the estuarine areas of the harbor. These sampling locations were fixed and remained unchanged during the course of the project. The sampling locations are presented in Table 2 and are depicted in Figure 1.

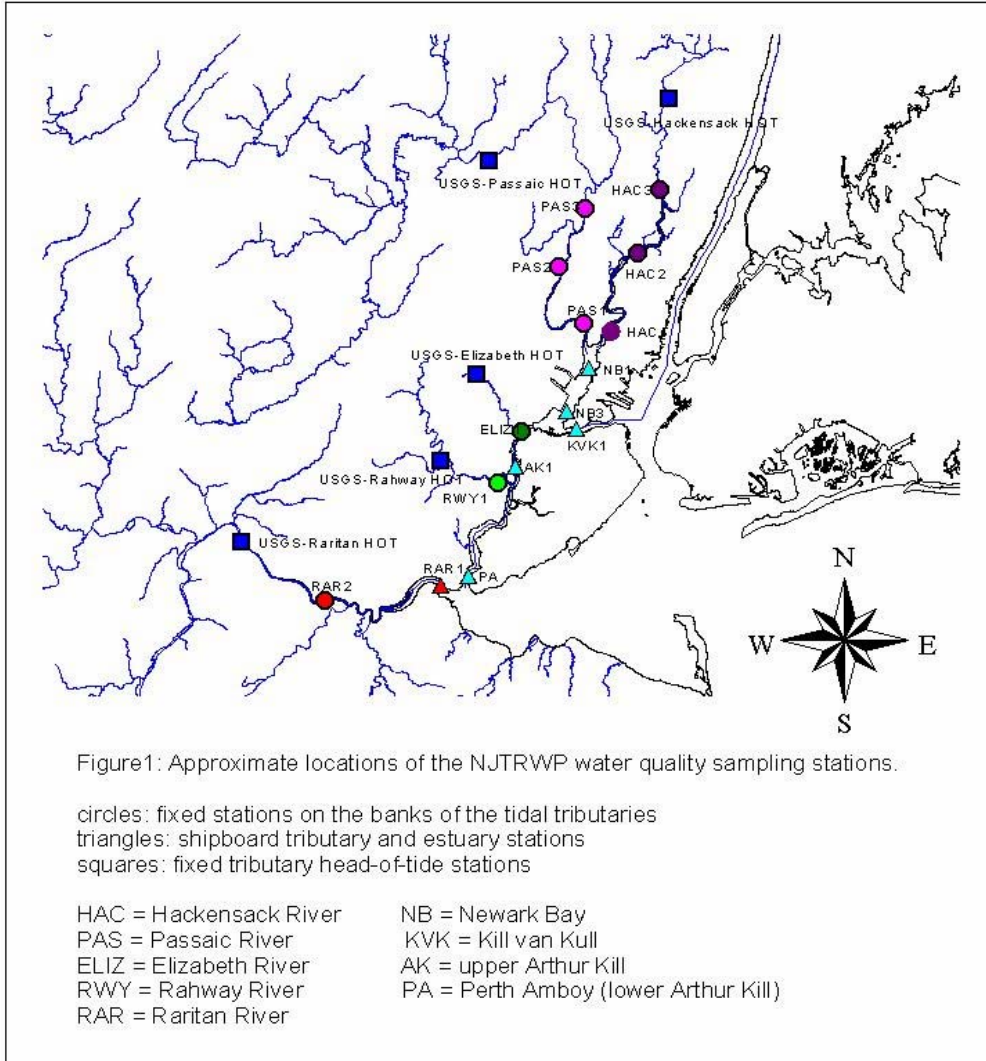
The decision to use fixed sampling stations vs. transects was taken after the completion of Task 5 of the NJTRWP Preliminary Sampling Program. The objective of Task 5 was to compare analytical results from a depth-averaged, time-composited sample at one location, with a cross-sectionally averaged, time-composited transect sample at the same location. This was tested at two locations, one in the Passaic River and the other in the Hackensack River. DOC analysis showed no significant variation along a transect across each river.

In addition to the water quality sampling, a variety of short and long-term hydrodynamic measurements were performed within the navigation channels at each of the ship-board locations and throughout NY-NJ Harbor. The measurements included the following.

- Measurements of the current profiles using moored and towed RDI Acoustic Doppler Current Profilers (ADCP);
- Conductivity-temperature-depth measurements using an Applied Microsystems CTD system.
- Measurements of suspended sediment concentration using a D&A Optical Backscatter Sensor (OBS).
- Measurements of suspended sediment concentration and particle size spectrum using a Sequoia LISST (laser-based scatterometer).

The hydrodynamic components of Studies I-D and I-E are presented and discussed in separate reports (Chant, 2006; Pence et al., 2006).





**Table 1: Target Analyte List**PCB Congeners (IUPAC)

3	4	5	8	10	11	15	16	17	18	19	22
25	26	27	28	31	33	37	40	42	43	44	45
46	47	48	49	50	52	53	56	59	60	62	63
64	66	70	74	75	77	81	82	84	85	86	87
91	92	95	97	99	101	104	105	110	114	118	119
123	126	128	132	134	135	136	137	138	141	146	149
151	153	154	156	157	158	166	167	168	169	170	171
172	174	177	178	179	180	183	185	187	189	190	191
194	195	196	198	200	201	203	205	206	207	208	209

PAHs

Acenaphthene  
 Acenaphthalylene  
 Anthracene  
 Benzo(a)anthracene  
 Benzo(a)pyrene  
 Benzo(b)fluoranthene  
 Benzo(e)pyrene  
 Benzo(ghi)perylene  
 Benzo(k)fluoranthene  
 Biphenyl  
 Chrysene  
 Dibenz(ah)anthracene  
 2,6-Dimethylnaphthalene  
 Fluoranthene  
 Fluorene  
 Indeno(1,2,3-cd)pyrene  
 1-Methylnaphthalene  
 2-Methylnaphthalene  
 1-Methylphananthrene  
 Naphthalene  
 Perylene  
 Phenanthrene  
 Pyrene  
 2,3,5-Trimethylnaphthalene  
 Total C2-Naphthalene  
 Total C3-Naphthalene  
 C1 Phenanthrenes/Anthracenes  
 C2 Phenanthrenes/Anthracenes

Pesticides

Aldrin  
 alpha-BHC  
 beta-BHC  
 gamma -BHC (Lindane)  
 alpha-Chlordane  
 gamma-Chlordane  
 oxy-Chlordane  
 2, 4'-DDD  
 4, 4'-DDD  
 2, 4'-DDE  
 4, 4'-DDE  
 2, 4'-DDT  
 4, 4'-DDT  
 Heptachlor  
 Hexachlorobenzene  
 Mirex  
 cis-Nonachlor  
 trans-Nonachlor  
 alpha-Endosulfan  
 beta-Endosulfan  
 Dieldrin  
 Endosulphan sulphate  
 Endrin  
 Endrin aldehyde  
 Endrin ketone  
 Heptachlor epoxide  
 Methoxychlor

Dioxins/Furans

2,3,7,8-TCDD  
 1,2,3,7,8-PCDD  
 1,2,3,4,7,8-TCDF  
 1,2,3,6,7,8-TCDF  
 1,2,3,7,8,9-TCDF  
 1,2,3,4,6,7,8-TCDF  
 OCDD  
 2,3,7,8-TCDF  
 1,2,3,7,8-PCDF  
 2,3,4,7,8-PCDF  
 1,2,3,4,7,8-PCDF  
 1,2,3,6,7,8-PCDF  
 2,3,4,6,7,8-PCDF  
 1,2,3,7,8,9-PCDF  
 1,2,3,4,6,7,8-PCDF  
 1,2,3,4,7,8,9-PCDF  
 OCDF  
 T4CDD Total  
 P5CDD Total  
 H6CDD Total  
 H7CDD Total  
 T4CDF Total  
 P5CDF Total  
 H6CDF Total  
 H7CDF Total

Metals (Total and dissolved)

Mercury  
 Methyl-mercury  
 Cadmium  
 Lead

Miscellaneous

Suspended Solids  
 Particulate Organic Carbon  
 Dissolved Organic Carbon

**Table 2: Water Quality Sampling Locations for NJTRWP Studies I-D and I-E**

Station ID	Location	Type	Latitude	Longitude
PAS1	0.5 mile north of confluence with Newark Bay; end of Blanchard Ave., Newark	Riverbank	40° 44.5' N	74° 07.7' W
PAS2*	Belleville Kearny Nutley High School dock	Riverbank	40° 47.1' N	74° 08.8' W
PAS2a	Riverside Park	Riverbank	40°48.1' N	74° 08.3' W
PAS3	Behind office complex on Madison St., Wallington	Riverbank	40° 50.8' N	74° 07.2' W
HAC1	0.5 mile north of confluence with Newark Bay; end of Duncan Ave., Jersey City	Riverbank	40° 44.1' N	74° 05.7' W
HAC2	Marina behind Red Roof Inn, Meadowlands Parkway, Secaucus	Riverbank	40° 47.9' N	74° 04.0' W
HAC3	Behind Shop-Rite, Bergen Turnpike	Riverbank	40° 51.6' N	74° 01.8' W
RAR1-S/D	Near Railroad Bridge, mid-channel	Ship-board	40° 29.7' N	74° 16.72' W
RAR2	Donaldson County Park, New Brunswick	Riverbank	40° 29.3' N	74° 25.4' W
RHWY1	Joseph Medwick Memorial Park, Carteret	Riverbank	40° 36.9' N	74° 13.2' W
ELIZ1	Elizabeth City Park, South Front Street	Riverbank	40° 38.6' N	74° 11.4' W
NB001-S/D	Newark Bay at the convergence of the Passaic and Hackensack Rivers	Ship-board	40° 40.7' N	74° 7.2' W
NB003	North of Shooters Island/Buoy 16	Ship-board	40° 40.7' N	74° 9.6' W
KVK1	Near the Bayonne Bridge in the Kill Van Kull	Ship-board	40° 40.6' N	74° 7.2' W
AK1-S/D	Near the Goethals Bridge in the Arthur Kill	Ship-board	40° 40.6' N	74° 12.0' W
PA-S/D	Perth Amboy/Red Buoy 60	Ship-board	40° 40.5' N	74° 15.6' W

\*Station PAS2 was used only during the December 2000 sampling event.

Note: "PAS" denotes Passaic River  
"HAC" denotes Hackensack River  
"RAR" denotes Raritan River  
"RHWY" denotes Rahway River  
"ELIZ" denotes Elizabeth River

"NB" denotes Newark Bay  
"AK" denotes Arthur Kill  
"KVK" denotes Kill van Kull  
"PA" denotes Perth Amboy

### **2.3 Sampling Schedule**

The Study I-D/E water and suspended sediment quality monitoring program was conducted over a two-year period (June 2000 – May 2002), and included a total of 12 sampling events. Sampling targeted defined dry weather/low flow and wet weather/high flow hydrologic conditions in the tributary rivers. A wet weather/high flow hydrologic event was defined as a rain storm or snow-melt that caused the river discharge to exceed the 10% exceedance level of flow, as established by the USGS historic discharge record for the gauging station at the head-of-tide on each tributary. Appendix A presents the USGS river flow magnitude ranking system. The selection of these sampling events was performed in coordination with the other NJTRWP investigators.

Due to the geographic variations in precipitation across all of the contributing watersheds, wet weather/high river flow events do not occur harbor-wide, that is, concurrently at all five major tributaries to the study area. Therefore, the harbor was divided into three survey areas:

- the northern tributaries, i.e. the Hackensack and Passaic Rivers, Newark Bay, the upper Arthur Kill, and the Kill van Kull,
- the southern tributaries (Region I), i.e. the Elizabeth and Rahway Rivers, and the upper Arthur Kill;
- the southern tributaries (Region II), i.e. the Raritan River and the lower Arthur Kill.

Each sampling event targeted the sampling stations located in one of these three survey areas. Table 3 shows the sampling schedule.

**Table 3: Sampling Schedule**

NJTRWP Survey #	River/Estuary	Station IDs Sampled	Date Sampled	River Flow Condition Storm Magnitude
2000-IDEA	Hackensack River	HAC1	6/21/2000	0
2000-IDEA	Passaic River	PAS1	6/21/2000	5
2000-IDEA	Newark Bay	NB001-S	6/20/2000	5
2000-IDEA	Newark Bay	NB001-D	6/20/2000	5
2000-IDEA	Newark Bay	NB001-S	6/22/2000	5
2000-IDEA	Newark Bay	NB001-D	6/22/2000	5
2000-IDA1	Hackensack River	HAC1	12/13/2000	5
2000-IDA1	Hackensack River	HAC2	12/13/2000	5
2000-IDA1	Hackensack River	HAC3	12/14/2000	5
2000-IDA1	Passaic River	PAS1	12/15/2000	5
2000-IDA1	Passaic River	PAS2	12/15/2000	5
2000-IDA1	Passaic River	PAS3	12/15/2000	5
2000-IEA1	Arthur Kill	AK1-S	12/14/2000	
2000-IEA1	Perth Amboy	PA-S	12/14/2000	
2000-IEA1	Kill Van Kull	KVK001	12/13/2000	
2000-IEA1	Newark Bay	NB001-S	12/14/2000	5
2000-IEA1	Newark Bay	NB001-D	12/15/2000	5
2000-IEA1	Newark Bay	NB003	12/15/2000	5
2001-IDA1	Hackensack River	HAC1	3/13/2001	5
2001-IDA1	Hackensack River	HAC2	3/13/2001	5
2001-IDA1	Hackensack River	HAC3	3/13/2001	5
2001-IDA1	Passaic River	PAS1	3/15/2001	6
2001-IDA1	Passaic River	PAS2a	3/15/2001	6
2001-IDA1	Passaic River	PAS3	3/15/2001	6
2001-IEA1	Arthur Kill	AK1-S	3/14/2001	
2001-IEA1	Perth Amboy	PA-S	3/14/2001	
2001-IEA1	Kill Van Kull	KVK001	3/13/2001	
2001-IEA1	Newark Bay	NB001-S	3/15/2001	6
2001-IEA1	Newark Bay	NB001-D	3/15/2001	6
2001-IEA1	Newark Bay	NB003	3/15/2001	6
2001-IDA2	Raritan River	RAR1-S/D*	4/12/2001	6
2001-IDA2	Raritan River	RAR2	4/12/2001	6
2001-IDA3	Elizabeth River	ELIZ1	4/25/2001	0
2001-IDA3	Rahway River	RHWY1	4/25/2001	0
2001-IEA3	Arthur Kill	AK1-S*/D	4/25/2001	

NJTRWP Survey #	River/Estuary	Station IDs Sampled	Date Sampled	River Flow Condition Storm Magnitude
2001-IEA3	Perth Amboy	PA-D	4/25/2001	
2001-IDB2	Raritan River	RAR1-S/D*	5/15/2001	0
2001-IDB2	Raritan River	RAR-2	5/15/2001	0
2001-IDB3	Elizabeth River	ELIZ1	5/22/2001	7
2001-IDB3	Rahway River	RHWY1	5/22/2001	6
2001-IEB3	Arthur Kill	AK1-D	5/22/2001	
2001-IEB3	Perth Amboy	PA-S	5/22/2001	
2001-IEB3	Perth Amboy	PA-D	5/22/2001	
2001-IDC1	Hackensack River	HAC1	10/17/2001	0
2001-IDC1	Hackensack River	HAC2	10/17/2001	0
2001-IDC1	Hackensack River	HAC3	10/17/2001	0
2001-IDC1	Passaic River	PAS1	10/19/2001	0
2001-IDC1	Passaic River	PAS2a	10/19/2001	0
2001-IDC1	Passaic River	PAS3	10/19/2001	0
2001-IEC1	Newark Bay	NB001-S	10/19/2001	0
2001-IEC1	Newark Bay	NB001-D	10/19/2001	0
2001-IEC1	Newark Bay	NB003	10/19/2001	0
2001-IEC1	Kill Van Kull	KVK001	10/17/2001	
2001-IDC2	Raritan River	RAR1-S/D*	10/3/2001	0
2001-IDC2	Raritan River	RAR2	10/3/2001	0
2001-IDD3	Elizabeth River	ELIZ1	11/6/2001	0
2001-IDD3	Rahway River	RWY1	11/6/2001	6
2001-IEC3	Arthur Kill	AK1-D	11/6/2001	
2001-IEC3	Perth Amboy South	PA-S	11/6/2001	
2001-IEC3	Perth Amboy	PA-D	11/6/2001	
2002-IDA1	Hackensack River	HAC1	3/14/2002	0 (no flow)
2002-IDA1	Hackensack River	HAC2	3/14/2002	0 (no flow)
2002-IDA1	Hackensack River	HAC3	3/14/2002	0 (no flow)
2002-IDA1	Passaic River	PAS1	3/12/2002	0
2002-IDA1	Passaic River	PAS2a	3/12/2002	0
2002-IDA1	Passaic River	PAS3@	3/12/2002	0
2002-IEA1	Newark Bay	NB001-S@	3/13/2002	0
2002-IEA1	Newark Bay	NB001-D@	3/13/2002	0
2002-IEA1	Newark Bay	NB003@	3/13/2002	0
2001-IEA1	Kill Van Kull	KVK001	3/14/2002	
2002-IDA2	Raritan River	RAR1-S/D*	3/27/2002	5
2002-IDA2	Raritan River	RAR-2	3/27/2002	5

NJTRWP Survey #	River/Estuary	Station IDs Sampled	Date Sampled	River Flow Condition Storm Magnitude
2002-IDA3	Elizabeth River	ELIZ1	5/14/2002	5
2002-IDA3	Rahway River	RWY1	5/14/2002	6
2002-IEA3	Arthur Kill	AK1-S/D*	5/14/2002	

Note: samples were usually collected at a depth of five (5) feet below the water surface. At some locations samples were collected at both this surface depth (denoted with an “S” suffix), as well as a depth of five (5) feet above the channel bottom (denoted with a “D” suffix).

\* only grab samples for metals collected.

@ no grab samples for metals collected.

See Appendix A and Section 5.1.2 for a description of the USGS river flow magnitude ranking system.

Additional details concerning the sampling programs can be found in the New Jersey Toxics Reduction Workplan (NJDEP, 2001a) and the NJTRWP Study I-D and I-E Quality Assurance Project Plans (NJDEP 2001b, c).

#### **2.4 Method for Riverbank Tributary Sampling Using SIT-TOPS**

The criteria for selecting the tributary riverbank sampling locations included:

- (1) access for the sampling crew;
- (2) the ability to conduct sampling from the shoreline, from a bulkhead, or from a bridge; and
- (3) a reasonable distance between stations on the river (i.e., greater than a tidal excursion between stations along the length of the river).

A portable 1000-watt generator supplied all electrical power requirements for sampling using the SIT-Trace Organics Platform Sampler (SIT-TOPS).

Sampling from the shoreline required running the SIT-TOPS ½-inch outside diameter Teflon intake line from the desired location in the river to the SIT-TOPS unit onshore. The key feature of the shore-based sampling is the maintenance of the intake of the sampling tube at the desired location in the channel. The first step was to determine the sampling location in the river from a detailed bathymetric survey in the vicinity of the shore station; i.e., typically over a semi-circle centered at the shore station with a radius equal to 100 feet. Since the sampling tube must be held in place by a moored, floating buoy we sought an in-river site with water depths exceeding 7-1/2 feet relative to mean low water. This would allow for the sampling hose to be suspended

at a depth of 5 feet below the water surface throughout the tidal cycle with no danger of the hose striking the bottom (i.e. sampling bottom sediments at low tide).

A completely non-metallic buoy was used. This buoy was attached via rope and a bungee cord (to allow for tidal differences) to a cinderblock resting on the river bottom. The anticipated drag force on the 100 feet of sampling hose in a 1-1/2 knot current is less than 40 pounds. Thus, a weight of about 100 pounds was sufficient to anchor the buoy.

The SIT-TOPS intake sampling tube was attached at 20-foot intervals to a continuous loop of rope running from the shore to the buoy, and back. The sampling tube was readily hauled out to the buoy and, most importantly, hauled back to shore if, for example, the intake became fouled. The continuous loop of rope ran through a plastic pulley. A 5-lb plastic weight was attached to the hose near the intake to hold the intake at a depth of five feet below the water surface.

The mooring system described above allowed the shore-based sampling team flexibility in the deployment and recovery of the sampling tube. The mooring was placed a day or two prior to the sampling event with the continuous loop of rope attached to the mooring buoy and to shore. In order to insure that the rope loop would not interfere with navigation it was attached to a 1/4-inch wire cable, which insured that both cable and rope would lie on the bottom prior to sampling. Upon arrival at the site, the sampling crew removed the cable and then attached the sampling tube, 8-inch buoy, and 5-lb weight to the loop of rope and hauled the tube out to the designated sampling site.

SIT-TOPS water and suspended sediment samples, and grab samples, were obtained over a period of approximately four hours, following the Standard Operating Procedures described in the SIT-SOP#3.

## **2.5 Shipboard Sampling Using SIT-TOPS**

Upon arrival at the sampling station, the research vessel was anchored and the vessel engines were shut down. All instrumentation was powered on and checked to insure proper operation. Using the on-board GPS system as well as landmarks (e.g., aids to navigation, proximity to shoreline), the vessel's position was noted in the vessel log. As in the riverbank tributary sampling, a 1/2-inch outside diameter Teflon intake line was used for SIT-TOPS sampling. A 5-lb plastic weight was attached to the hose near the intake to hold the intake at a depth of five feet below the water surface (and for some locations, 5 feet above the bottom of the navigation channel). SIT-TOPS water and suspended sediment samples, and grab samples, were obtained over a period of approximately four hours, following the Standard Operating Procedures described in the SIT-SOP#3. The shipboard SIT-TOPS sampling was coordinated with the hydrodynamic surveys.



### 3 Sampling Procedures/Methodology

#### 3.1 Description of the SIT-TOPS

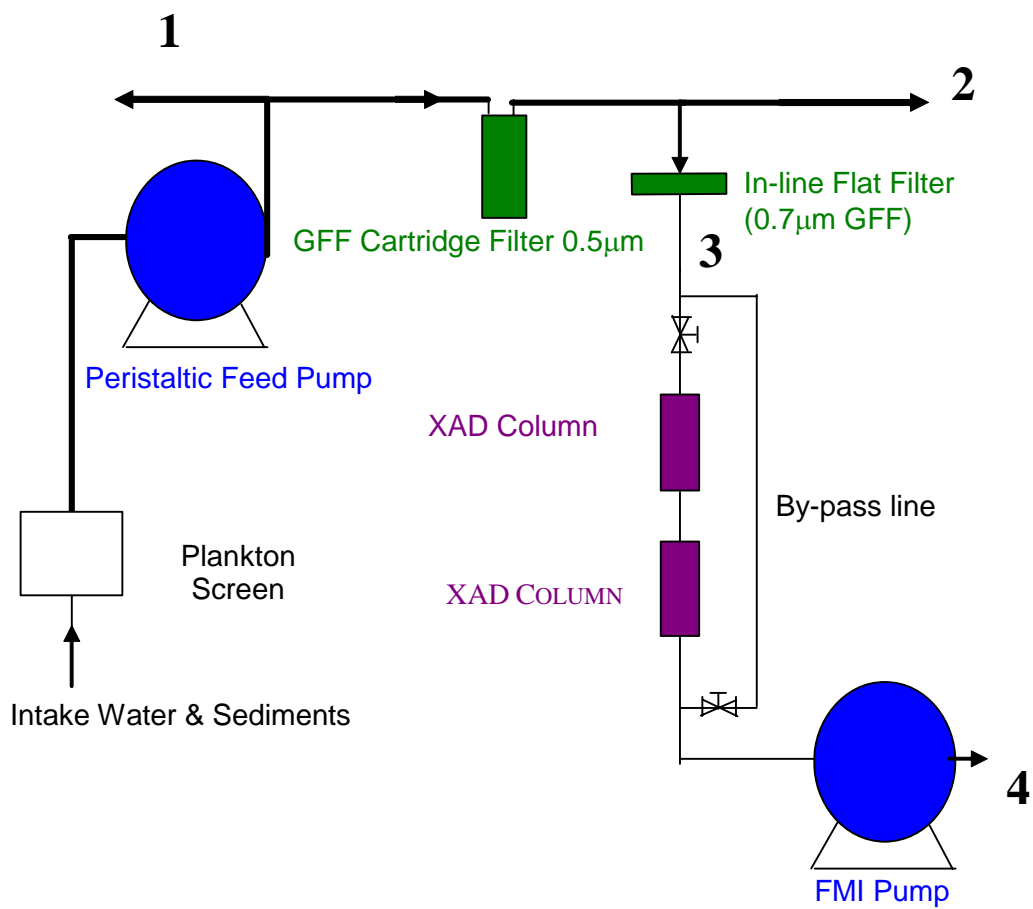
Water and suspended sediment quality monitoring was performed using the Stevens Modified Trace Organics Platform Sampler (SIT-TOPS), following the Standard Operating Procedures described in the SIT-SOP#3. A schematic diagram of the SIT-TOPS unit is shown in Figure 2.

Each SIT-TOPS unit used for sampling was equipped with a plankton net, filters to remove sediments from the ambient water, and two XAD resin columns to retain trace organics (PCBs and pesticides).

The plankton net was manufactured by Wildlife Supply Company (Buffalo, NY), and was made of 100 µm-mesh Bolt Cloth-Nitex. It was placed in a 2-liter (2L) Teflon jar equipped with ½-inch male connectors.

Each SIT-TOPS unit was equipped with two types of filters, and two XAD resin columns placed in series:

- A baked 0.5 µm nominal size retention, 4” long Cartridge GFF filter (C-GFF) located in the discharge line of the peristaltic pump right after sampling port 1. The C-GFF filter was pre-cleaned by STL, Inc.
- A 142 mm diameter in-line 0.7 µm GF/F Whatman glass microfiber filter (“flat filter”) located before the XAD columns. This filter was also pre-cleaned by STL, Inc.
- Two XAD resin columns connected in series located between the in-line flat filter and the FMI pump. STL Inc. provided the XAD resin columns. The first XAD column is spiked by STL, Inc. with labeled PCBs and pesticides prior to its shipment to SIT.



### Sampling Ports

1. Intake. Water Sampling port for Metals, PAHs, SS, POC and DOC
2. Waste line. Sampling for SS
3. Post in-line filter. Sampling for SS via by-pass line through port 4
4. Post XAD columns. Sampling port for SS, POC and DOC

**Figure 2:** Schematic Diagram of the Stevens Modified TOPS (SIT-TOPS)

### **3.2 SIT-TOPS Operating Parameters**

A minimum target volume of 50 liters of water through the XAD resin columns was initially identified to ensure that a sufficient mass of dissolved PCBs and pesticides would be trapped in these columns so as to achieve the desired analytical detection limits. The peristaltic feed pump flow rate was set at approximately 2000 ml/min. To minimize “breakthrough” effects on the XAD resin columns, the flow rate of the FMI pump was set at approximately 350 ml/min, and was monitored so that it would not go below 200 ml/min. The flow rates delivered by the peristaltic feed pump and the FMI pump were monitored at 30 minutes intervals. In order to check the total amount of water that was passed through the XAD resin columns, 20L graduated carboys were placed after the XAD columns and all the water passing through the columns was collected. The inline flat filters were replaced as needed in order to maintain the flow rate in the FMI line above the 200 ml/min threshold value. Based on the above considerations, the duration of the sampling event was set at 4 hours to ensure that a target volume of 50L of filtered ambient water flowed through the XAD columns.

Likewise, a minimum target mass of 5 grams (wet weight) of suspended sediment captured on the SIT-TOPS filters was identified to ensure that a sufficient mass of PCBs, pesticides, dioxins/furans, and PAHs would be trapped so as to achieve the desired analytical detection limits.

### **3.3 Sampling**

Samples collected during NJTRWP Studies I-D and I-E were collected, to the greatest extent possible, on the outgoing tide. Under optimal conditions, sample collection began no earlier than one (1) hour before slack high tide at each sampling location, and continued no longer than one (1) hour after slack low tide. For the water and suspended sediment quality monitoring program, each SIT-TOPS unit was in operation for a minimum of 4 hours. During each SIT-TOPS 4-hour run, aqueous samples were taken at hourly intervals through the sampling ports at the intake, waste line, post in-line flat filter, and post XAD columns. All samples collected through these sampling ports were analyzed for SS, Specific Conductivity, POC, and DOC (as described in SIT-SOP #2). In addition, samples were collected at the SIT-TOPS intake for metals and PAHs analysis (SIT-SOP #2).

A baked 0.5  $\mu\text{m}$  nominal size retention 4” long Cartridge GFF filter (C-GFF) and a 142 mm diameter in-line 0.7  $\mu\text{m}$  GF/F Whatman glass microfiber filter (“flat filter”) were used to collect the suspended sediment fraction. A set of two XAD resin columns placed in series was used to collect the dissolved fraction. The filters and XAD resin columns were separately extracted and analyzed for trace organics contaminants (see Tables 1 and 4). Grab samples for metals analysis and dissolved PAHs were collected at the SIT-TOPS intake.

At the start of the sampling run ( $t=0$ ) a one-liter sample was taken at the inlet of the plankton screen to determine SS. At the end of the run, plankton trapped in the plankton filter was recovered for Chlorophyll a analysis.

The sampling requirements for water and suspended sediment quality monitoring with the SIT-TOPS are summarized in Table 4.

**Table 4: Sampling Requirements for a SIT-TOPS 4-Hour Water Quality Sampling Run**

<b>PLANKTON FILTER</b>			
<b>ANALYTE</b>	<b>VOLUME</b>	<b># of SAMPLES</b>	<b>COMMENTS</b>
SS	1 Liter	1 (t=0)	
Chlorophyll <u>a</u>	40 ml vial	1 (t=0)	
<b>Sampling Port # 1: TOPS Intake</b>			
Metals	500 ml	3 (t=0)	The metals grab samples (total, dissolved, and & methyl-Hg) were collected without a plankton filter. The PAH dissolved fraction grab samples were filtered by the analytical laboratory.
PAHs (dissolved)	500 ml	4 (t=1,2,3,4)	
SS POC/DOC	1 Liter 1 Liter	4 (t=1,2,3,4) 4 (t=1,2,3,4)	
<b>Sampling Port # 2: TOPS Waste Line</b>			
SS	2 Liter	4 (t=1,2,3,4)	
POC/DOC	1 Liter	4 (t=1,2,3,4)	
<b>Sampling Port # 3: TOPS Post In-Line Flat Filter</b>			
SS	4 Liter	4 (t=1,2,3,4)	
POC/DOC	1 Liter	4 (t=1,2,3,4)	
<b>Sampling Port # 4: TOPS Post XAD Columns</b>			
SS POC/DOC	4 Liter 1 Liter	4 (t=1,2,3,4) 4 (t=1,2,3,4)	
<b>XAD Columns &amp; In Line Filter &amp;GFF Cartridge Filter</b>			
Trace organics	XAD columns	1	1 spiked/1 unspiked
Trace organics	GFF Filter	1	Along with residuals from C-GFF canister
Trace organics	Flat filters	Variable	

Note: t = time in hours from the initiation of sampling.

SS = suspended sediment

POC = particulate organic carbon

DOC = dissolved organic carbon

## 4 Sample Analysis

### 4.1 Laboratories Performing the Sample Analyses

#### Analyses performed by STL Inc. (Knoxville, TN):

- XAD resin for dissolved PCBs (HR GC/MS; modified USEPA Method 1668A) and pesticides (HR GC/MS; STL KNOX ID-0014)
- Grab samples for dissolved PAHs (LR GC/MS; STL KNOX ID-0016)
- C-GFF, flat filters, and residual sediments in cartridge housing for PCBs, PCDD/Fs (HR GC/MS; USEPA Method 1613B), PAHs, and pesticides.

#### Analyses performed by Frontier Geosciences (Seattle, WA):

- Metals: Total and Dissolved Mercury (CV-AFS; USEPA Method 1631B)
- Metals: Total and Dissolved Cadmium and Lead (ICP-MS; modified USEPA Method 1638)
- Metals: Total and Dissolved methyl-Mercury (GC, CV-AFS; USEPA Method 1630)

#### Analyses performed by USGS (Kentucky):

- SS (filtration and gravimetric analysis)

#### Analyses performed by USGS (Colorado):

- POC (IR spectrometry; USEPA Method 440.0)
- DOC (IR spectrometry; USEPA Method 440.0)

### 4.2 Quality Assurance (QA) Program Overview

The NJTRWP Quality Assurance Program is described in detail in the document “The New Jersey Toxics Reduction Workplan – Volume II – Quality Assurance Project Plan” (Version 2.2 – February 2003 [final draft]) prepared by the NJ Department of Environmental Protection (2003). A comprehensive and integrated QA program has been developed for the NJTRWP that includes planning, control, assessment, reporting, and correction activities to ensure that environmental data of documented quality is obtained. The NJDEP is committed to collecting scientifically valid data that is of the highest quality. This policy is implemented by ensuring that adequate QA procedures are employed for all data generating activities, including study design, sample analysis, and data generation, reduction, and reporting.

The protocols and SOPs developed to collect, handle, transport, process and analyze the samples include procedures designed to maintain sample integrity and to prevent contamination of the samples. NJDEP staff conducted frequent on-site visits/audits of field sampling activities to

ensure that sample collection procedures were performed as specified in the applicable Quality Assurance Project Plans and SOPs.

Each analytical laboratory is required to operate its own quality assurance program, as required by the various analytical procedures to be used. At a minimum, for each analytical procedure, the laboratory will be required to provide the following:

- An initial demonstration of laboratory capability;
- An analysis of spiked/labeled compounds or other QA samples to evaluate and document data quality;
- Preparation of standards and calibration curves;
- An analysis of laboratory method blanks and control samples (LCS).

#### **4.3 Data Analysis - Blank Correction Process**

The protocols and SOPs developed to collect, handle, transport, process and analyze the samples include procedures designed to maintain sample integrity and to prevent contamination of the samples.

Because of the number and nature of the samples and associated blanks to be collected, a “maximum blank” approach has been developed to assess the impact of blank contamination on the usability of the sample data. In general, none of the blanks collected is indicative of the total potential contamination effecting a sample, nor can they be added together to provide an estimate of “total contamination”. In this “maximum blank” approach, the Method, Equipment, and Field Blanks associated with a sample are evaluated for each analyte/congener. Of the three blank results, that having the largest value – i.e. the “maximum blank” – is used to assess the effects of blank contamination on the sample result. In order for a sample result to be usable, it must be at least five times (5x) greater than the “maximum blank” (3x for PCBs). No other blank correction/subtraction is performed on the sample result prior to use.

The use of a “5x factor” and “maximum blank” approach when assessing data usability is based, in part, on data validation guidance from USEPA Region IV (USEPA, 1998) and Region X (USEPA, 1995) concerning method blank analysis:

*Action in the case of blank contamination depends on the circumstances and origin of the blank. Qualification should be based upon comparison with the associated blank having the highest concentration of a contaminant ...Any compound detected in the sample that was also detected in any associated blank is not reported if the sample concentration is less than five times (5x) the blank concentration. Typically, the quantitation limit is raised to the concentration found in the sample and the U qualifier flag is applied. If the compound is present in the sample in an amount less than the detection limit (DL), then the DL should be reported with the U flag.*

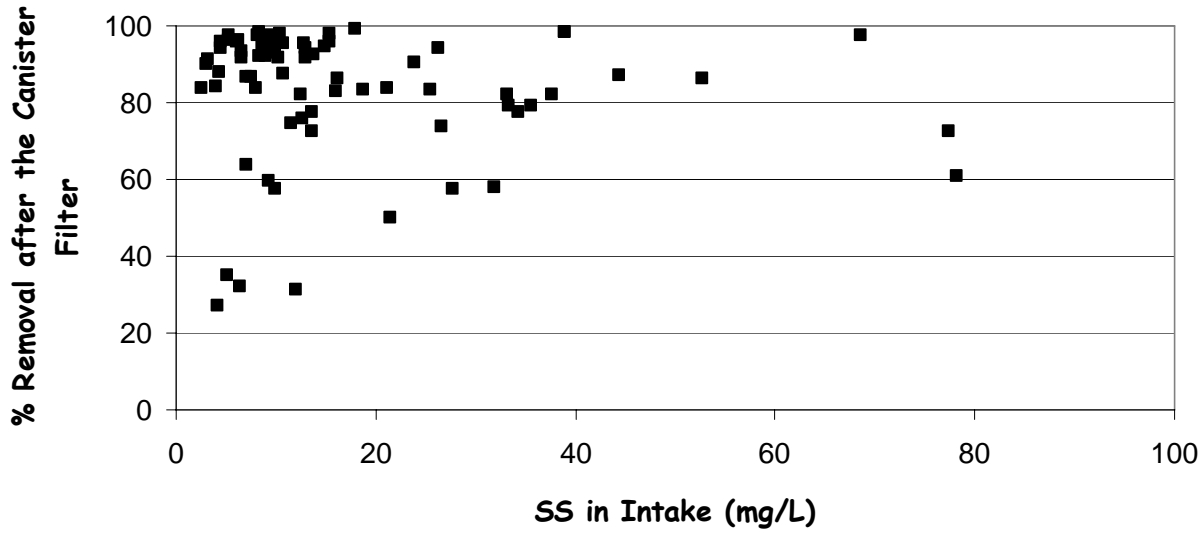
#### **4.4 SS Removal using SIT-TOPS**

Figures 3 and 4 show the percentage removal of SS after the C-GFF, and after both the C-GFF and inline flat filters, respectively. The mean SS removal after the C-GFF filter is 82%, whereas the mean removal after the both the C-GFF and inline flat filters is 96%. In particular, at low SS concentrations (e.g. in the case of predominantly very fine sediments) the C-GFF filter alone functions very poorly, which may result in a significant underestimation of suspended sediment organic concentrations since fine sediments tend to have higher concentrations of organic contaminants. Likewise, this could result in an overestimation of the dissolved fraction if these fine sediments are subsequently trapped on the XAD resin columns. Thus, the use of an additional inline flat filter is necessary to increase the percentage of SS captured, as well as to decrease the percentage passing through the filters and into the XAD resin columns. A detailed analysis of the effectiveness of the SIT-TOPS and various combinations of filters and TOPS operating parameters in separating the suspended sediment and dissolved fractions is provided in the report “New Jersey Toxics Reduction Workplan Preliminary Sampling Program – Procedures and Methodology Development: TSS Mass Balance Study for Trace Organic Platform Samplers” (Draft Final Report, Revised February 2002).

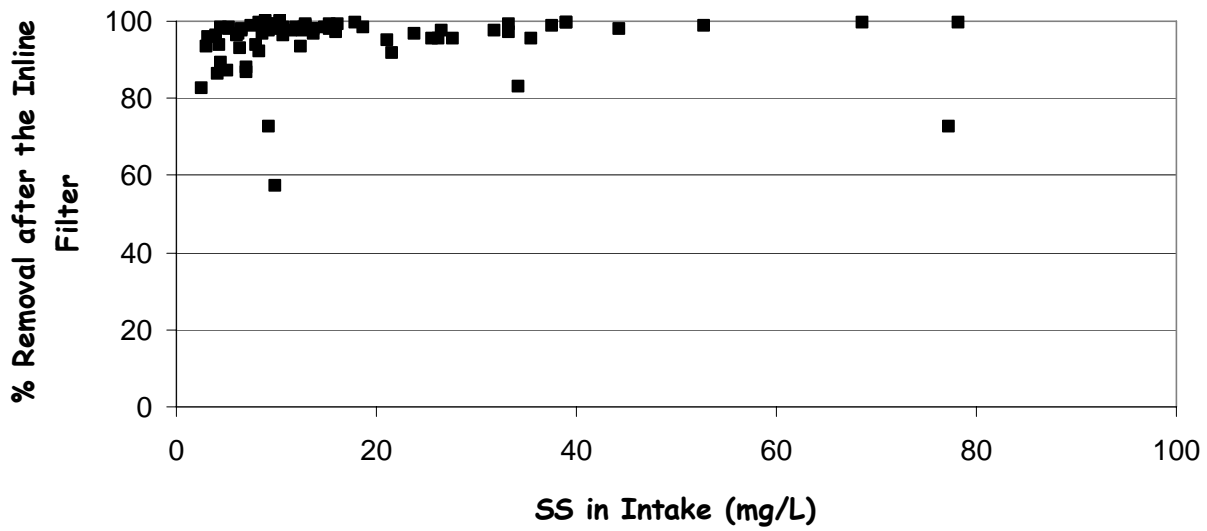
#### **4.5 POC Removal using SIT-TOPS**

Figures 5 and 6 show the percentage removal of POC after the C-GFF, and after both the C-GFF and the inline flat filters, respectively. The mean POC removal after the C-GFF filter is only 47%, whereas the mean removal after the C-GFF and inline flat filters is 76%. The reason for the lower mean percentage of POC removal vs. SS removal is that finer sediments, which can pass through the filters, have higher POC concentrations.

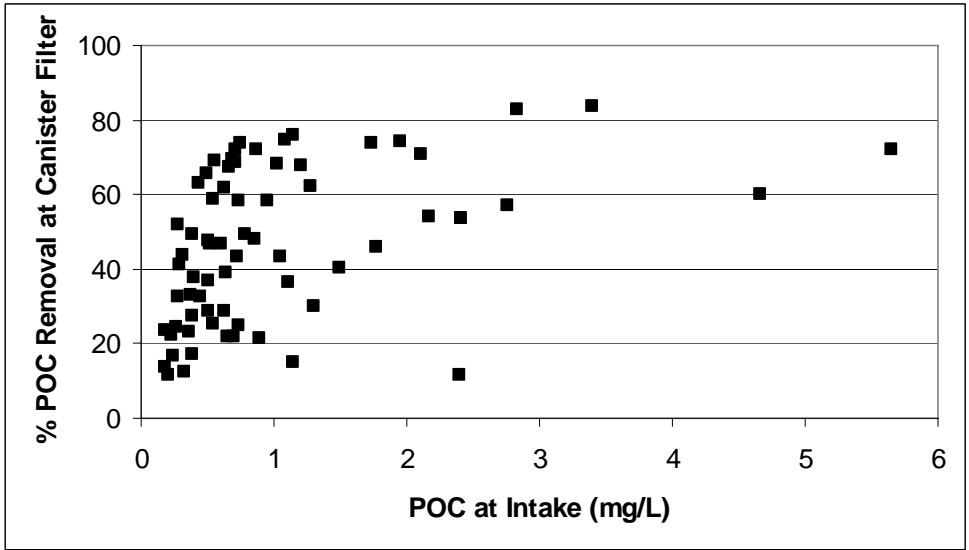




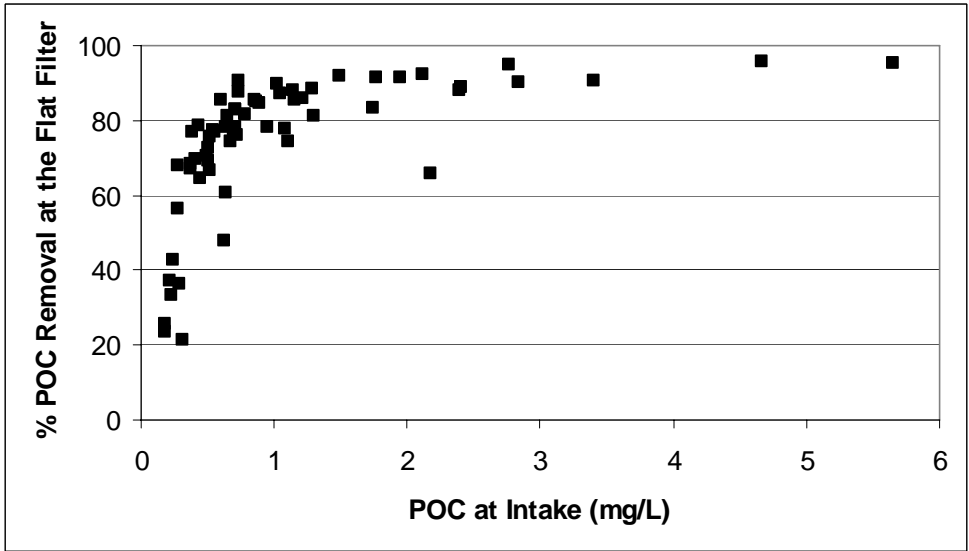
**Figure 3:** Percentage removal of SS after the C-GFF (canister) filter.



**Figure 4:** Percentage removal of SS after the C-GFF and inline flat filters.



**Figure 5:** Percentage Removal of POC after the C-GFF (canister) filter.



**Figure 6:** Percentage removal of POC after the C-GFF and inline flat filters.

## 5 Results

### 5.1 Suspended Solids (SS)

#### 5.1.1 Measurements

The grab samples that were used for SS analysis were collected at each SIT-TOPS sampling port at each hour (t = 1, 2, 3, 4) during the course of sampling, as follows (also see Figure 2 and Table 4):

- The peristaltic pump outlet - for SS in the intake water: 1-L sample every hour
- The TOPS waste line - for SS after the C-GFF: 2-L sample every hour
- The TOPS FMI line before the XAD resin columns - for SS after the C-GFF and inline filters: 4-L sample every hour
- The TOPS FMI line after the XAD resin columns - for SS after the XAD columns: 4-L sample every hour.

The SS analysis (IR spectrometry; USEPA Method 440.0) was conducted using a 0.4 µm filter.

Table 5 and Figure 7 present the geometric mean of the SS concentrations (mg/L) at the SIT-TOPS Intake at each sampling station for each sampling event, as well as the overall arithmetic mean and standard deviation of this data. Table 6 presents the range of the SS concentrations (mg/L) at the SIT-TOPS Intake at each sampling station during each sampling event. In general, the coefficient of variation (ratio of the standard deviation over the arithmetic mean, an indicator of data variability) is higher in the tributaries (range = 0.207 to 1.132) compared to the estuary stations (range = 0.195 to 0.630).

The highest mean SS concentrations were measured in the Rahway River (overall mean concentration is 65.48 mg/L; see Table 5), the upper Hackensack River (Station HAC3 mean = 45.32 mg/L), and the lower/mid Passaic River (Station PAS1 mean = 34.45 mg/L, Station PAS2 mean = 31.26 mg/L). Overall mean SS concentrations at the remaining tributary stations ranged between 9.74 and 19.67 mg/L. The overall mean SS concentrations in the estuary stations were all less than 12 mg/L (7.54 -11.76 mg/L).

**Table 5:** Geometric Mean SS Concentration (mg/L) at the SIT-TOPS Intake at each sampling station for each sampling event.

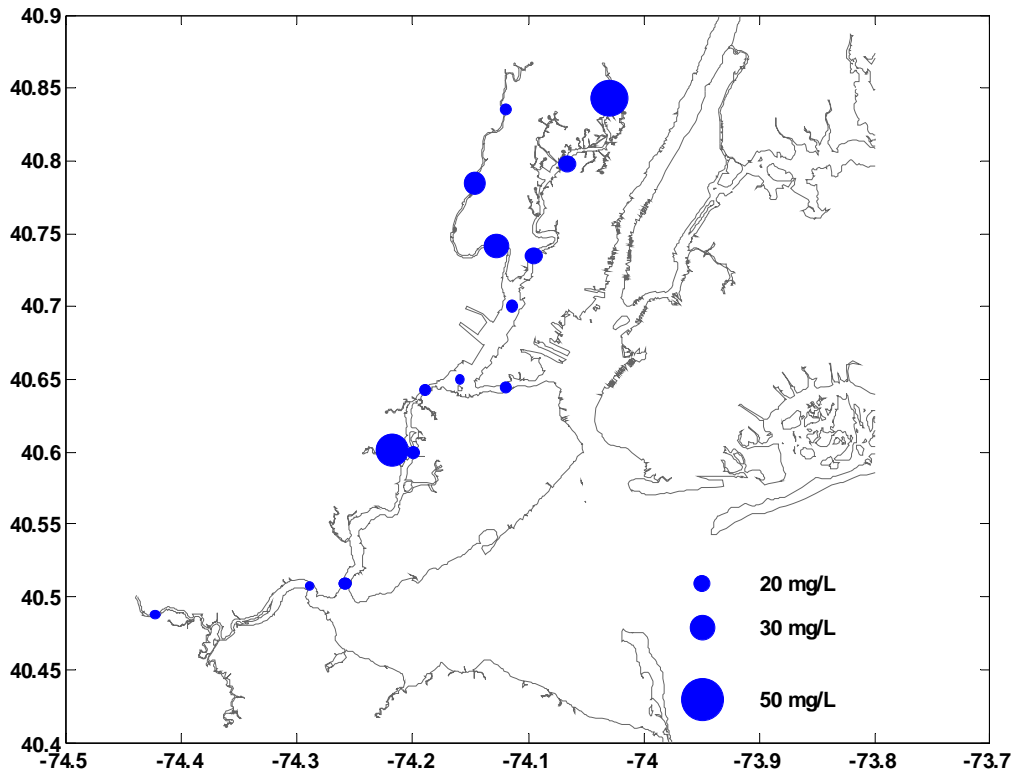
	6/20-22/00	12/13-15/00	3/13-15/01	4/12/01	4/25/01	5/15/01	5/24/01	10/17-19/01	10/3/01	11/6/01	3/12-14/02	3/27/02	5/14/02	Overall Mean	Std. Dev.
<b>PAS1</b>	44.37	37.65	11.57					68.64			10.00			34.45	24.49
<b>PAS2/ PAS2a</b>		52.73*	7.01					39.00			26.29			31.26	19.44
<b>PAS3</b>		5.18	4.10					39.00			17.87			16.54	16.23
<b>NB1-S</b>	12.49	13.69	6.51					21.15			4.52			11.67	6.56
<b>NB1-D</b>	7.46	18.74	9.55					13.83			6.19			11.15	5.14
<b>NB3</b>		6.53	8.62					9.71			5.31			7.54	1.99
<b>AK1-S</b>		14.91	10.75										8.35	11.34	3.32
<b>AK1-D</b>					8.21		9.03			6.09				7.78	1.52
<b>PA-S</b>		9.30	12.99				10.74			4.42				9.36	3.63
<b>PA-D</b>					12.01		15.99			3.19				10.40	6.55
<b>HAC1</b>	23.60	33.27	10.26					23.85			3.96			18.99	11.74
<b>HAC2</b>		27.75	12.61					31.83			6.47			19.67	12.07
<b>HAC3</b>		78.24	35.57					34.23			33.25			45.32	21.97
<b>KVK1</b>		12.84	10.46					15.41			8.34			11.76	3.05
<b>RAR1-S</b>				16.24		4.25			3.09			15.37		9.74	7.03
<b>RAR2</b>				9.34		8.06			12.98			9.92		10.08	2.09
<b>RWY1</b>					13.65		165.59			5.32			77.34	65.48	74.09
<b>ELIZ1</b>					7.52		26.58			2.57			6.97	10.91	10.68

\* The December 2000 sample was collected at Station PAS2 while construction activities were underway just upstream; all other samples were collected at Station PAS2a.

**Table 6:** Range of SS concentrations (mg/L) at the SIT-TOPS Intake at each sampling station during each sampling event.

	6/20- 22/00	12/13- 15/00	3/13- 15/01	4/12/01	4/25/01	5/15/01	5/24/01	10/17- 19/01	10/3/01	11/6/01	3/12- 14/02	3/27/02	5/14/02
<b>PAS1</b>	26.5 - 140.7	20.2 - 62.0	8.1 - 40.8					36.4 - 106.3			5.6 - 13.2		
<b>PAS2</b>		35.4 - 72.4*	6.0 - 8.7					27.5 - 68.6			19.4 - 32.7		
<b>PAS3</b>		4.3 - 6.7	3.1 - 4.7					25.3 - 49.1			16.3 - 20.6		
<b>NB001-S</b>	10.5 - 15.0	7.4 - 25.3	6.0 - 7.3					6.0 - 39.5			3.5 - 5.2		
<b>NB001-D</b>	17.5 - 24.2	12.9 - 32.3	8.0 - 11.0					8.6 - 18.4			3.1 - 12.3		
<b>NB003</b>		5.0 - 10.5	6.4 - 11.2					6.9 - 12.5			4.6 - 6.8		
<b>AK1-S</b>		12.5 - 18.8	8.4 - 12.5										6.8 - 11.9
<b>AK1-D</b>					5.7 - 11.9		5.7-17.5			5.1 - 8.3			
<b>PA-S</b>		7.2 - 12.7	10.1 - 16.8				7.3-15.7			3.7 - 5.9			
<b>PA-D</b>					8.8 - 16.1		13.4- 18.7			1.6 - 5.6			
<b>HAC1</b>	22.4 - 28.9	19.5 - 47.0	6.2 - 15.0					8.9 - 56.1			2.7 - 6.0		
<b>HAC2</b>		24.7 - 33.0	9.2 - 18.0					26.0 - 39.2			4.0 - 8.8		
<b>HAC3</b>		73.6 - 81.8	22.8 - 51.9					8.2 - 158.7			16.7 - 53.0		
<b>KVK1</b>		10.8 - 15.2	9.9 - 11.1					12.2 - 23.5			4.9 - 26.1		
<b>RAR1</b>				10.2 - 22.2		3.2 - 5.3			2.3 - 4.9				11.1 - 17.6
<b>RAR2</b>				8.7 - 9.8		6.6 - 9.7			9.3 - 14.7				8.1 - 12.4
<b>RHWY1</b>					9.0 - 17.5		127.2- 214.8			3.7 - 9.2			43.8 - 107.6
<b>ELIZ1</b>					2.2 - 74.3		7.2-45			1.2 - 3.3			6.7 - 7.3

\* The December 2000 sample was collected at Station PAS2 while construction activities were underway just upstream; all other samples were collected at Station PAS2a.



**Figure 7:** Overall Mean of the Geometric Mean SS (mg/L) concentrations at the SIT-TOPS Intake at each sampling station for each sampling event (see Table 5).

### 5.1.2 Wet Weather vs. Dry Weather Sampling Events

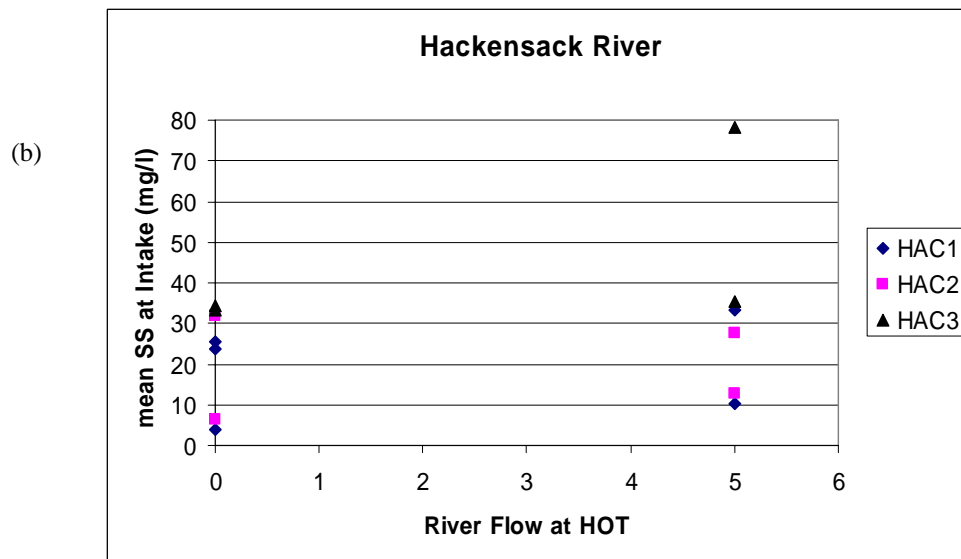
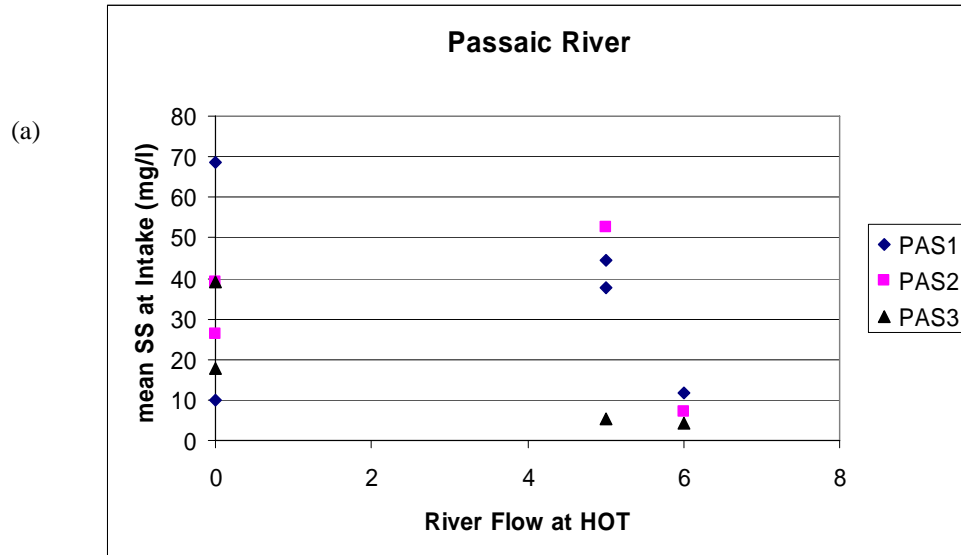
In order to be consistent with the USGS categorization scheme for river flow conditions at its head-of-tide stations (see Appendix A and Table 3), the following terms are used to characterize dry and wet weather events:

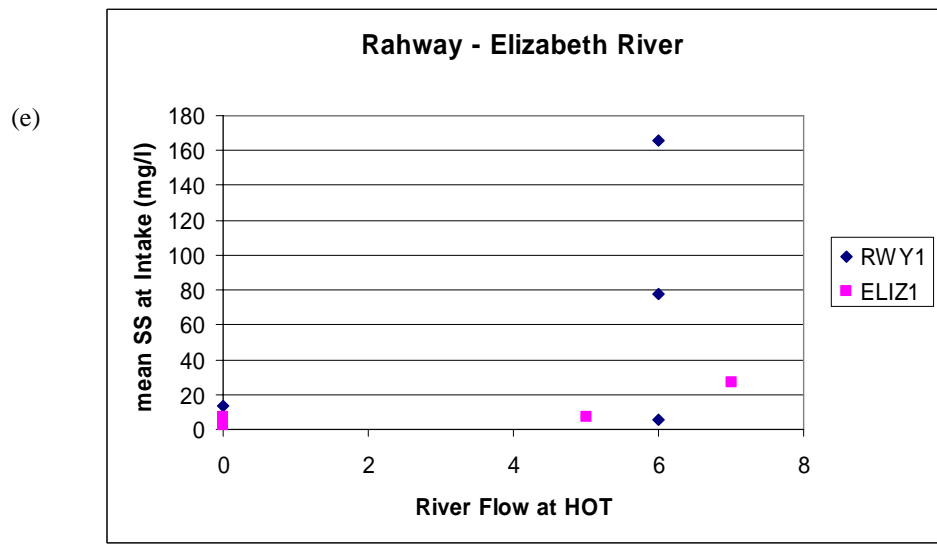
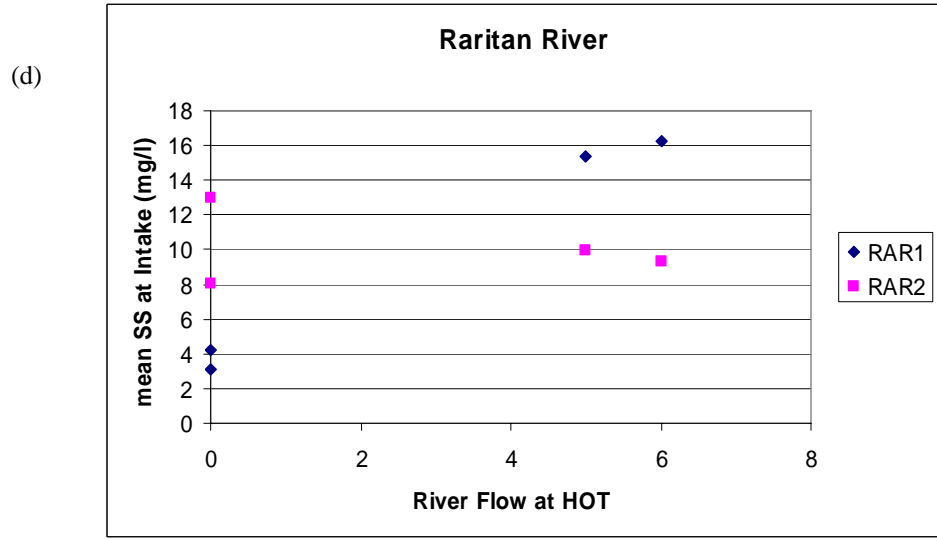
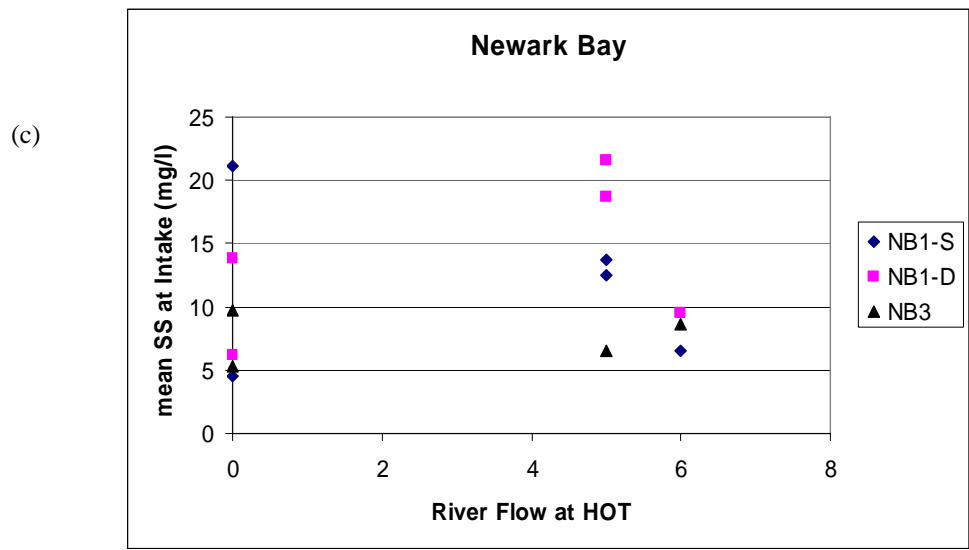
- A dry weather event/survey (i.e. baseflow condition) is categorized as a “Magnitude 0 Storm”;
- A wet weather event/survey is categorized as a "Magnitude 1-7 Storm", based on the flow conditions at the USGS head-of-tide station for a given river.

Figure 8(a-e) shows a comparison between the mean dry weather and wet weather event SS concentrations at all of the sampling stations (except Stations KVK001, AK1, and PA). The Passaic River event river flow categorization was used for Newark Bay conditions.

Given the limited number of data points and the variability in the data, it is difficult to make any firm conclusions on wet vs. dry event trends. However, note the following general observations:

- Stations in the in the Rahway and Raritan Rivers (Station RAR1) tend to show increased SS concentrations during wet events;
- Stations in the Passaic River tend to show increased concentrations during dry events.



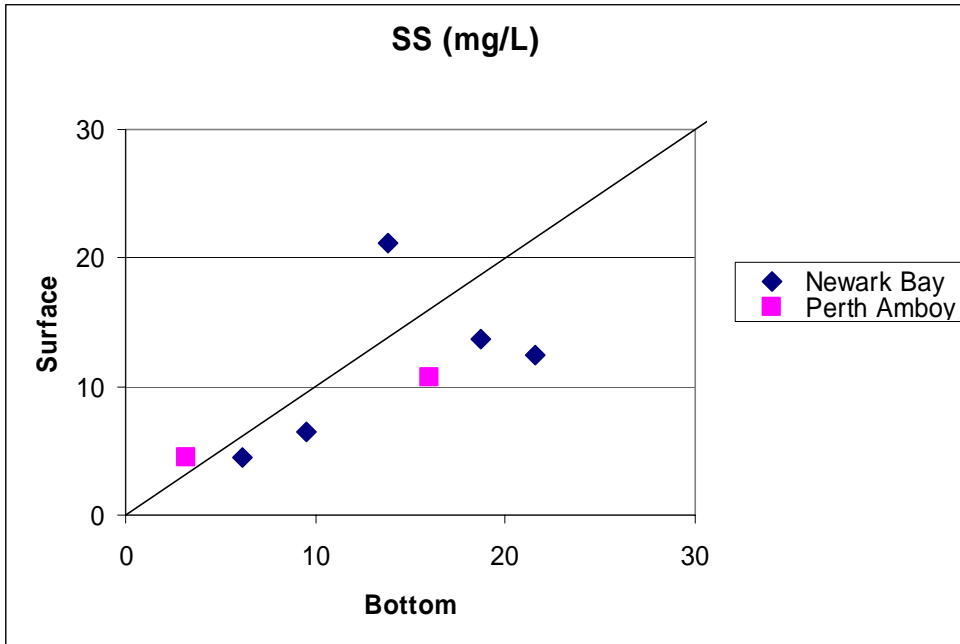


**Figure 8 (a-e): Geometric Mean SS Concentrations – Wet vs. Dry Sampling Events.**



### 5.1.3 Surface vs. Bottom Samples

At Stations NB001 and PA, both surface (5 ft below the surface) and bottom (5ft above the bottom) samples were taken. As shown in Figure 9, the bottom samples usually had slightly higher SS concentrations than the surface samples at both stations.



**Figure 9:** Geometric Mean SS Concentrations at Stations NB001 and PA - Surface vs. Bottom samples.

## 5.2 Dissolved Organic Carbon (DOC) and Particulate Organic Carbon (POC)

### 5.2.1 Measurements

The grab samples that were used for DOC and POC analysis were collected at each SIT-TOPS sampling port at each hour (t = 1, 2, 3, 4) during the course of sampling, as follows (also see Figure 2 and Table 4):

- The peristaltic pump outlet - for DOC and POC in the intake water: 1-L sample every hour
- The TOPS waste line - for DOC and POC after the C-GFF: 2-L sample every hour
- The TOPS FMI line before the XAD resin columns - for DOC and POC after the C-GFF and inline filters: 4-L sample every hour
- The TOPS FMI line after the XAD resin columns - for DOC and POC after the XAD columns: 4-L sample every hour.

Table 7 presents the range of the measured DOC concentrations (mg/L) at the SIT-TOPS Intake at all sampling stations during all sampling events. Table 8 and Figure 10 present the geometric mean of the DOC concentrations (mg/L) at the SIT-TOPS Intake at each sampling station for each sampling event, as well as the overall arithmetic mean and standard deviation of this data. The coefficient of variation is less than 0.33 at all of the stations, with no consistent trend between the tributary and estuarine stations.

The highest mean DOC concentrations were found in the mid/upper Hackensack River (Station HAC2 mean = 6.61 mg/L, Station HAC3 mean = 7.54 mg/L) and the mid/upper Passaic River (Station PAS2a mean = 5.46 mg/L, Station PAS3 mean = 5.14 mg/L). The mean DOC concentration was less than 3.22 mg/L at all of the estuary stations (except Station NB001-S), and it was greater than 3.44 mg/L at all of the tributary stations.

Table 9 presents the range of the measured POC concentrations (mg/L) at the SIT-TOPS Intake at all sampling stations during all sampling events. Table 10 and Figure 11 present the geometric mean of the POC concentrations (mg/L) at the SIT-TOPS Intake at each sampling station for each sampling event, as well as the overall arithmetic mean and standard deviation of this data. For the most part, the coefficient of variation at the estuarine stations (range = 0.267 to 0.498, except for Station PA-D = 0.751) was less than that at the tributary stations (range = 0.397 to 0.994). A similar trend in variability was observed for the SS data (see Section 5.1.1).

The highest mean POC concentrations were measured in the upper Hackensack River at Station HAC3 (mean concentration = 3.56 mg/L). In general, the estuary stations show lower mean POC concentrations (range = 0.41 to 0.81 mg/L) than the tributary stations (range = 0.59 to 3.56 mg/L). A similar trend was observed for the mean SS data (see Section 5.1.1).

**Table 7:** Range of DOC concentrations (mg/L) at the SIT-TOPS Intake at each sampling station during each sampling event.

	6/20- 22/00	12/13- 15/00	3/13- 15/01	4/12/01	4/25/01	5/15/01	5/24/01	10/17- 19/01	10/3/01	11/6/01	3/12- 14/02	3/27/02	5/14/02
<b>PAS1</b>	3.53 - 5.26	2.42 - 3.67	3.94 - 5.08					4.13 - 5.11			5.48 - 6.20		
<b>PAS2/ PAS2a</b>		3.54 - 3.99*	4.91 - 8.85					5.41 - 5.90			6.06 - 6.43		
<b>PAS3</b>		3.35 - 4.08	3.58 - 5.22					5.04 - 5.92			6.80 - 6.94		
<b>NB001-S</b>	3.79 - 4.88	2.79 - 2.96	3.73 - 5.31					3.58 - 4.80			4.85 - 5.60		
<b>NB001-D</b>	2.33 - 4.40	2.05 - 2.17	2.25 - 7.09					2.99 - 3.83			2.35 - 3.04		
<b>NB3</b>		1.96 - 3.11	2.67 - 6.08					3.09 - 4.50			2.08 - 2.34		
<b>AK1-S</b>		2.72 - 2.82	3.31 - 4.63										2.31 - 2.60
<b>AK1-D</b>					2.13 - 4.24		2.45 - 2.79			2.22 - 2.90			
<b>PA-S</b>		1.81 - 2.20	2.59 - 5.24				2.94 - 4.47			2.50 - 2.62			
<b>PA-D</b>					2.55 - 3.40		2.03 - 2.73			2.24 - 2.91			
<b>HAC1</b>	2.93 - 4.96	2.55 - 3.46	3.05 - 6.07					3.79 - 4.38			2.76 - 3.45		
<b>HAC2</b>		5.64 - 6.61	6.18 - 7.96					6.31 - 7.33			6.49 - 7.27		
<b>HAC3</b>		5.64 - 7.32	6.04 - 7.17					7.21 - 7.62			9.08 - 9.66		
<b>KVK1</b>		2.66 - 2.91	3.15 - 10.77					2.86 - 2.95			1.79 - 2.61		
<b>RAR1</b>				3.50 - 4.16		2.79 - 3.96			4.47 - 5.87			2.66 - 3.16	
<b>RAR2</b>				3.17 - 3.68		4.92 - 5.75			4.60 - 5.69			4.48 - 4.90	
<b>RWY1</b>					4.64 - 5.58		4.86 - 5.66			3.14 - 5.60			4.51 - 4.97
<b>ELIZ1</b>					2.33 - 4.05		3.38 - 5.83			2.12 - 2.59			2.63 - 3.54

\* The December 2000 sample was collected at Station PAS2 while construction activities were underway just upstream; all other samples were collected at Station PAS2a.

**Table 8:** Geometric Mean DOC Concentration (mg/L) at the SIT-TOPS Intake at each sampling station for each sampling event.

	6/20- 22/00	12/13- 15/00	3/13- 15/01	4/12/01	4/25/01	5/15/01	5/24/01	10/17- 19/01	10/3/01	11/6/01	3/12- 14/02	3/27/02	5/14/02	Overall Mean	Std. Dev.
<b>PAS1</b>	4.25	2.88	4.43					4.57			5.76			4.38	1.03
<b>PAS2/ PAS2a</b>		3.73*	6.16					5.70			6.25			5.46	1.18
<b>PAS3</b>		3.66	4.48					5.57			6.86			5.14	1.39
<b>NB1-S</b>	4.48	2.87	4.38					4.27			5.22			4.24	0.85
<b>NB1-D</b>	2.97	2.09	3.60					3.53			2.74			2.99	0.62
<b>NB3</b>		2.48	4.22					3.92			2.24			3.22	1.00
<b>AK1-S</b>		2.78	3.82										2.49	3.03	0.70
<b>AK1-D</b>					2.81		2.68			2.54				2.68	0.14
<b>PA-S</b>		1.96	3.90				3.50			2.57				2.98	0.88
<b>PA-D</b>					2.90		2.33			2.44				2.56	0.30
<b>HAC1</b>	3.81	3.01	3.70					4.05			3.01			3.52	0.48
<b>HAC2</b>		5.97	6.92					6.79			6.75			6.61	0.43
<b>HAC3</b>		6.62	6.72					7.45			9.36			7.54	1.27
<b>KVK1</b>		2.76	4.77					3.01			2.35			3.22	1.07
<b>RAR1-S</b>				3.86		3.05			5.08			2.86		3.71	1.01
<b>RAR2</b>				3.39		5.26			4.85			4.62		4.53	0.80
<b>RWY1</b>					5.00		5.22			4.00			4.70	4.73	0.53
<b>ELIZ1</b>					3.19		5.04			2.34			3.19	3.44	1.14

\* The December 2000 sample was collected at Station PAS2 while construction activities were underway just upstream; all other samples were collected at Station PAS2a.

**Table 9:** Range of POC concentrations (mg/L) at the SIT-TOPS Intake at each sampling station during each sampling event.

	6/20- 22/00	12/13- 15/00	3/13- 15/01	4/12/01	4/25/01	5/15/01	5/24/01	10/17- 19/01	10/3/01	11/6/01	3/12- 14/02	3/27/02	5/14/02
<b>PAS1</b>	2.09 - 3.30	1.01 - 4.08	0.37 - 0.84					0.16 - 0.61			0.85 - 1.70		
<b>PAS2/ PAS2a</b>		2.69 - 5.10*	0.30 - 0.93					0.89 - 2.20			2.35 - 3.29		
<b>PAS3</b>		0.91 - 1.30	0.56 - 0.74					0.74 - 1.68			1.57 - 2.56		
<b>NB001-S</b>	0.76 - 0.83	0.92 - 1.27	0.57 - 0.88					0.12 - 0.64			0.52 - 0.80		
<b>NB001-D</b>	0.41 - 1.36	0.64 - 1.32	0.32 - 0.42					0.15 - 0.52			0.58 - 0.95		
<b>NB3</b>		0.49 - 0.59	0.25 - 0.31					0.20 - 0.37			0.52 - 0.63		
<b>AK1-S</b>		0.48 - 1.12	0.22 - 0.59										0.41 - 0.66
<b>AK1-D</b>					0.27 - 1.83		0.32 - 1.22			0.16 - 0.27			
<b>PA-S</b>		0.45 - 0.55	0.77 - 1.38				0.60 - 1.28			0.31 - 0.43			
<b>PA-D</b>					1.24 - 1.67		0.48 - 0.84			0.29 - 0.36			
<b>HAC1</b>	0.88 - 1.45	1.04 - 5.46	0.37 - 0.44					0.12 - 0.82			0.56 - 0.77		
<b>HAC2</b>		1.72 - 1.84	0.76 - 1.30					0.57 - 0.96			1.08 - 1.58		
<b>HAC3</b>		4.17 - 4.88	1.66 - 4.3					2.35 - 13.08			0.97 - 1.36		
<b>KVK1</b>		0.62 - 0.77	0.23 - 0.33					0.25 - 0.52			0.39 - 0.56		
<b>RAR1</b>				0.82 - 1.27		0.70 - 0.71			0.21 - 0.31			1.43 - 2.23	
<b>RAR2</b>				0.45 - 0.76		0.62 - 1.17			0.16 - 0.21			0.74 - 1.04	
<b>RWY1</b>					0.65		0.57 - 5.32#			0.26 - 0.61			2.08 - 3.29
<b>ELIZ1</b>					0.72		0.57 - 5.32#			0.13 - 0.22			0.38 - 0.76

\* The December 2000 sample was collected at Station PAS2 while construction activities were underway just upstream; all other samples were collected at Station PAS2a.

# The POC data associated with the May 2001 Rahway River and Elizabeth River samples are identical. To date, efforts to resolve this problem and correct the data have not been successful. Therefore, the POC data for these two samples should be used with caution.

**Table 10:** Geometric Mean POC Concentration (mg/L) at the SIT-TOPS Intake at each sampling station for each sampling event.

	6/20-22/00	12/13-15/00	3/13-15/01	4/12/01	4/25/01	5/15/01	5/24/01	10/17-19/01	10/3/01	11/6/01	3/12-14/02	3/27/02	5/14/02	Overall Mean	Std. Dev.
<b>PAS1</b>	2.68	2.11	0.64					0.23			1.21			1.37	1.01
<b>PAS2/ PAS2a</b>		3.40*	0.51					1.28			2.84			2.01	1.34
<b>PAS3</b>		1.11	0.65					1.02			2.17			1.24	0.65
<b>NB1-S</b>	0.80	1.08	0.67					0.27			0.69			0.70	0.29
<b>NB1-D</b>	0.65	0.86	0.37					0.31			0.71			0.58	0.23
<b>NB3</b>		0.52	0.28					0.28			0.56			0.41	0.15
<b>AK1-S</b>		0.74	0.44										0.54	0.58	0.15
<b>AK1-D</b>					0.50		0.51			0.21				0.41	0.17
<b>PA-S</b>		0.49	1.14					0.73			0.37			0.69	0.34
<b>PA-D</b>					1.50		0.61			0.33				0.81	0.61
<b>HAC1</b>	1.10	1.95	0.40					0.39			0.63			0.89	0.66
<b>HAC2</b>		1.77	0.89					0.73			1.30			1.17	0.46
<b>HAC3</b>		4.66	2.76					5.65			1.15			3.56	2.00
<b>KVK1</b>		0.71	0.28					0.38			0.44			0.45	0.18
<b>RAR1-S</b>				0.95		0.70			0.25			1.74		0.91	0.63
<b>RAR2</b>				0.55		0.85			0.18			0.79		0.59	0.30
<b>RWY1</b>					1.04		2.41#			0.39			2.40	1.56	1.01
<b>ELIZ1</b>					0.72		2.41#			0.18			0.63	0.98	0.98

\* The December 2000 sample was collected at Station PAS2 while construction activities were underway just upstream; all other samples were collected at Station PAS2a.

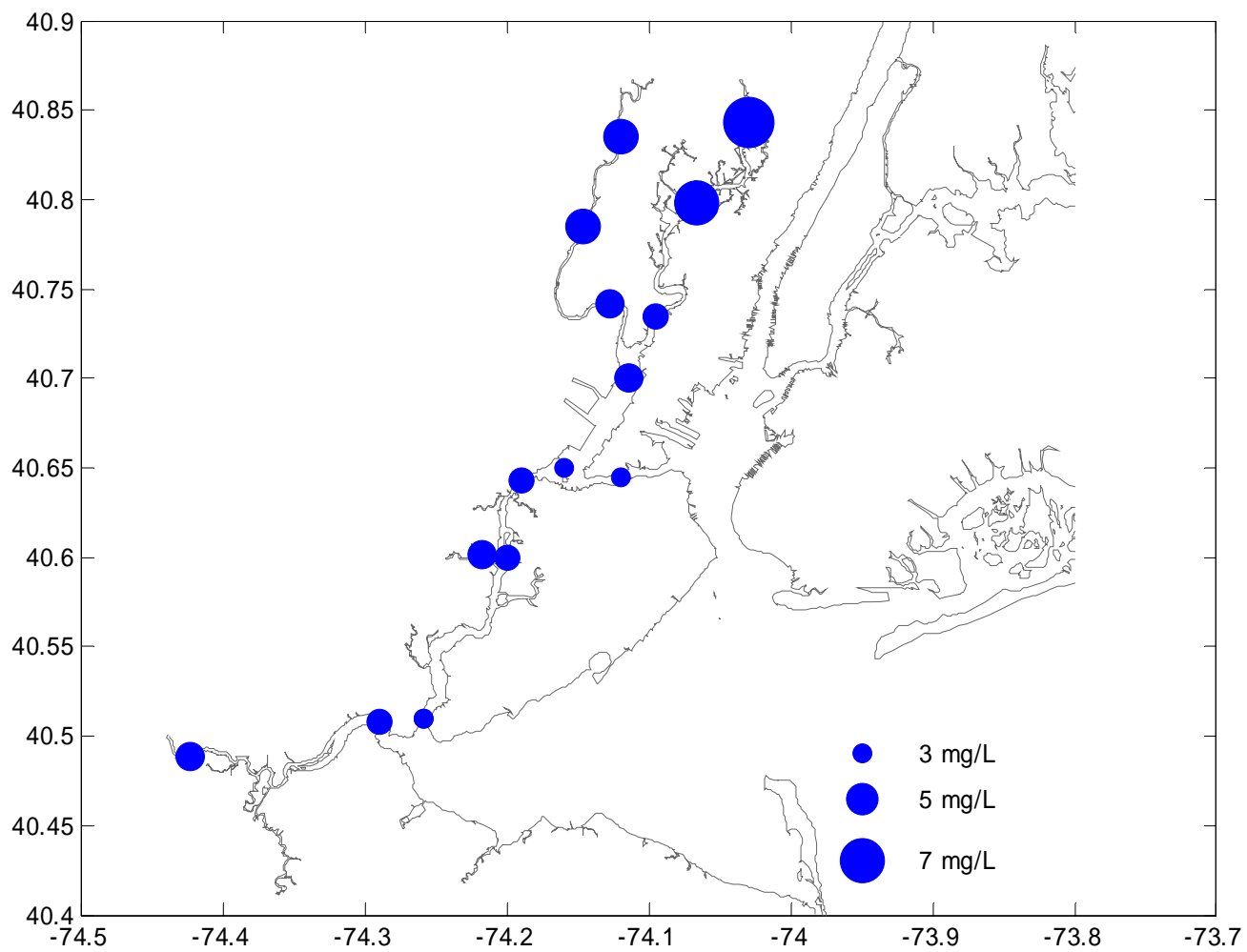
# The POC data associated with the May 2001 Rahway River and Elizabeth River samples are identical. To date, efforts to resolve this problem and correct the data have not been successful. Therefore, the POC data for these two samples should be used with caution.

Table 11 and Figure 12 present the geometric mean  $f_{oc}$  ratio (g Carbon/g sed) at the SIT-TOPS Intake at each sampling station for each sampling event, as well as the overall arithmetic mean and standard deviation of this data. In general, mean  $f_{oc}$  values ranged between 0.04 gC/g sed and 0.09gC/g sed, with higher values at Station RAR1-S (0.10 gC/g sed) and Station PAS3 (0.13 gC/g sed).

**Table 11:** Geometric Mean  $f_{oc}$  ratio(g C /g sed) at the SIT-TOPS Intake at each sampling station for each sampling event.

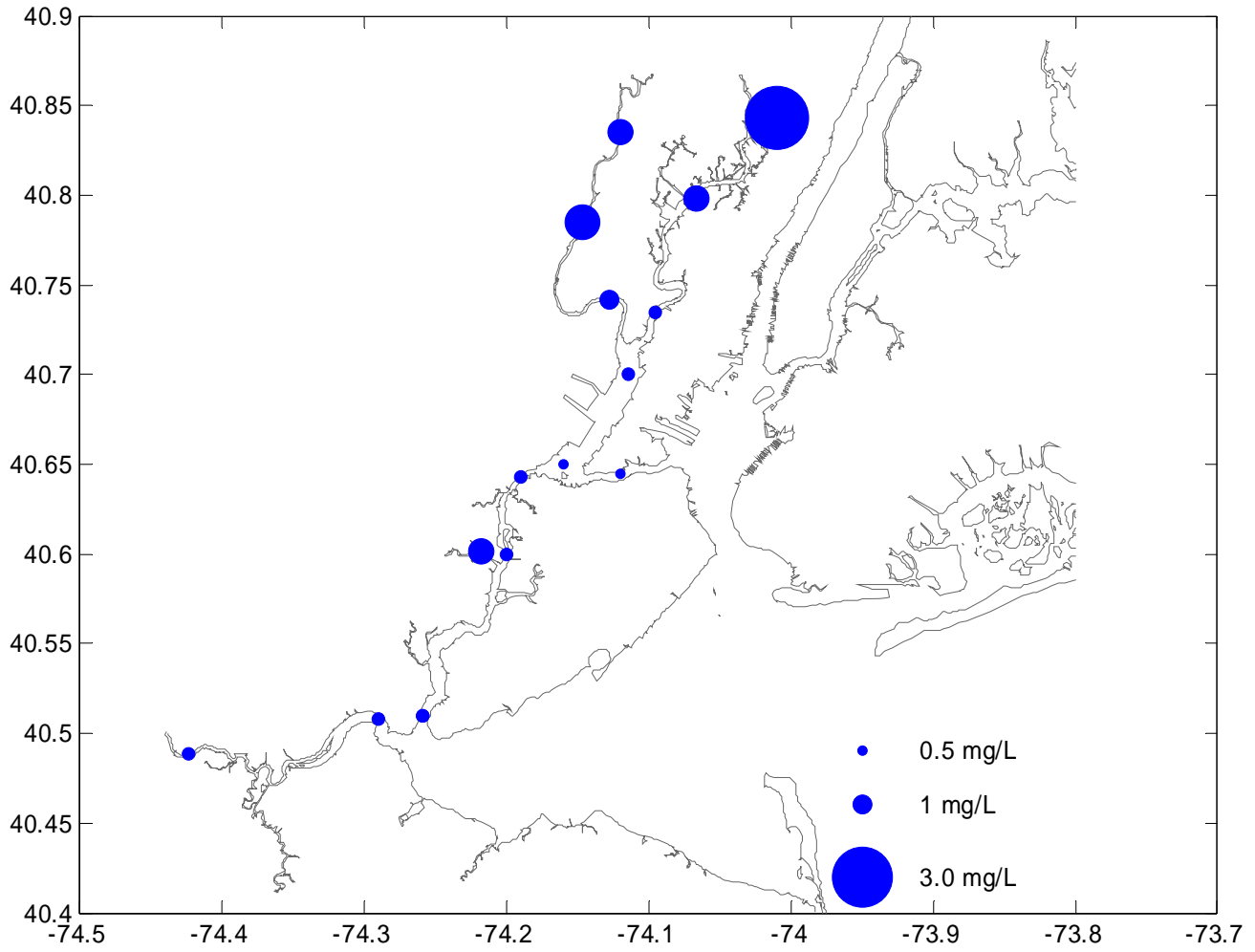
	6/20- 22/00	12/13- 15/00	3/13- 15/01	4/12/01	4/25/01	5/15/01	5/24/01	10/17- 19/01	10/3/01	11/6/01	3/12- 14/02	3/27/02	5/14/02	Overall Mean	Std. Dev.
<b>PAS1</b>	0.06	0.06	0.06					0.00			0.12			0.06	0.04
<b>PAS2/ PAS2a</b>		0.06*	0.07					0.03			0.11			0.07	0.03
<b>PAS3</b>		0.21	0.16					0.03			0.12			0.13	0.08
<b>NB1-S</b>	0.06	0.08	0.10					0.01			0.15			0.08	0.05
<b>NB1-D</b>	0.09	0.05	0.04					0.02			0.11			0.06	0.04
<b>NB3</b>		0.08	0.03					0.03			0.11			0.06	0.04
<b>AK1-S</b>		0.05	0.04										0.06	0.05	0.01
<b>AK1-D</b>					0.06		0.06			0.03				0.05	0.01
<b>PA-S</b>		0.05	0.09				0.07			0.08				0.07	0.02
<b>PA-D</b>					0.12		0.04			0.10				0.09	0.05
<b>HAC1</b>	0.05	0.06	0.04					0.02			0.16			0.06	0.06
<b>HAC2</b>		0.06	0.07					0.02			0.20			0.09	0.08
<b>HAC3</b>		0.06	0.08					0.16			0.03			0.08	0.06
<b>KVK1</b>		0.06	0.03					0.02			0.05			0.04	0.02
<b>RAR1-S</b>				0.06		0.17			0.08			0.11		0.10	0.05
<b>RAR2</b>				0.06		0.11			0.01			0.08		0.06	0.04
<b>RWY1</b>					0.08		0.01			0.07			0.03	0.05	0.03
<b>ELIZ1</b>					0.10		0.09			0.07			0.09	0.09	0.01

\* The December 2000 sample was collected at Station PAS2 while construction activities were underway just upstream; all other samples were collected at Station PAS2a.

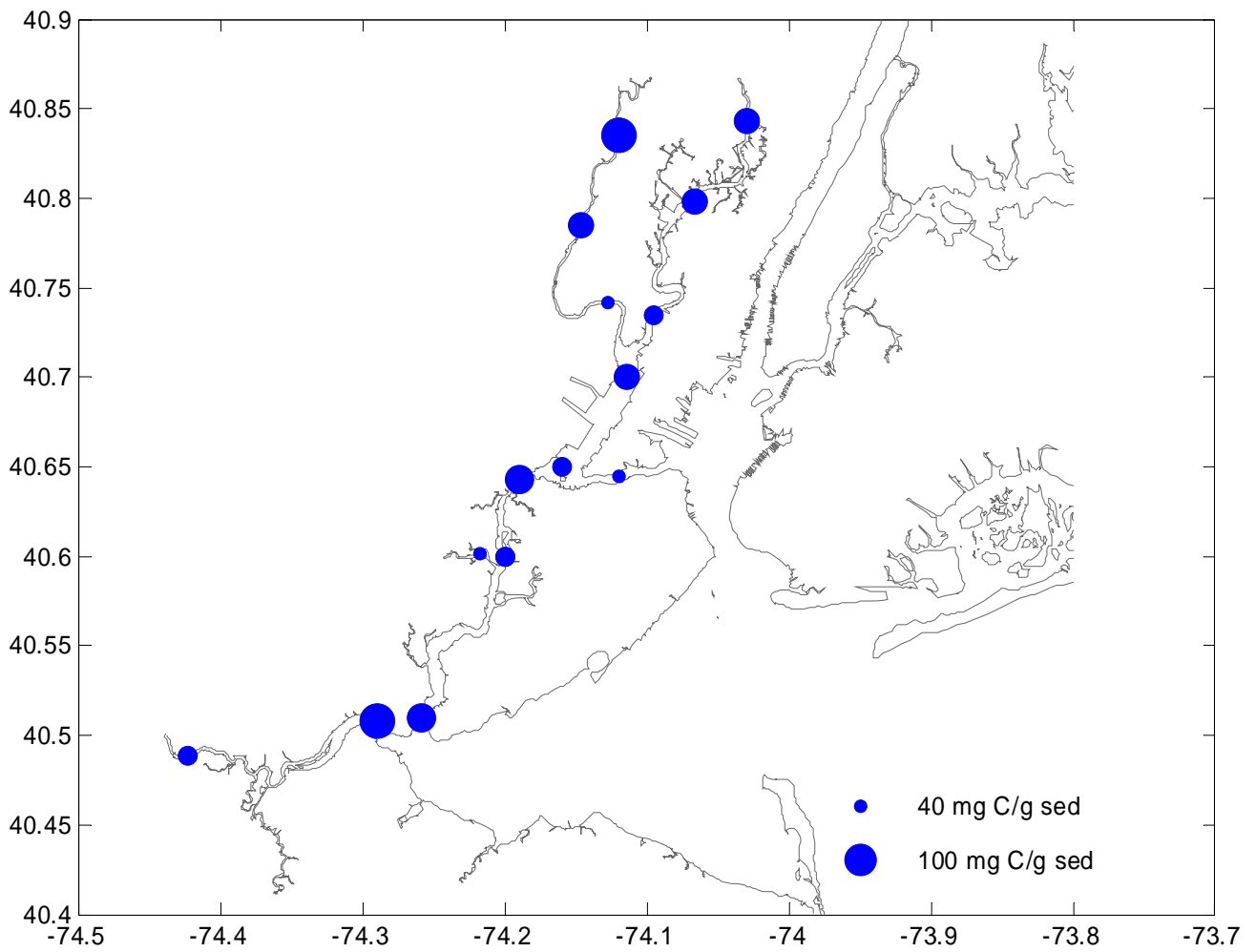


**Figure 10:** Overall Mean of the Geometric Mean DOC (mg/L) concentrations at the SIT-TOPS Intake at each sampling station for each sampling event (see Table 8).





**Figure 11:** Overall Mean of the Geometric Mean POC (mg/L) concentrations at the SIT-TOPS Intake at each sampling station for each sampling event (see Table 10).



**Figure 12:** Overall Mean of the Geometric Mean  $f_{OC}$  ratio (mg C/g sed) at the SIT-TOPS Intake at each sampling station for each sampling event (see Table 11).

### 5.2.2 Wet vs. Dry Events

Figure 13(a-e) shows the mean DOC concentrations in the Passaic, Hackensack, Rahway, Elizabeth, and Raritan Rivers, and in Newark Bay, as a function of river flow conditions (i.e. storm magnitude, see Appendix A and Table 3). The Passaic River event river flow categorization was used for Newark Bay conditions. Given the limited number of data points and the variability in the data, it is difficult to make any firm conclusions on wet vs. dry event trends. However, note the following general observations:

- in the upper Passaic River (Station PAS3) and upper Hackensack River (Station HAC3), DOC concentrations tended to decrease during wet events;
- in the Elizabeth River, DOC tended to increase during wet weather events.

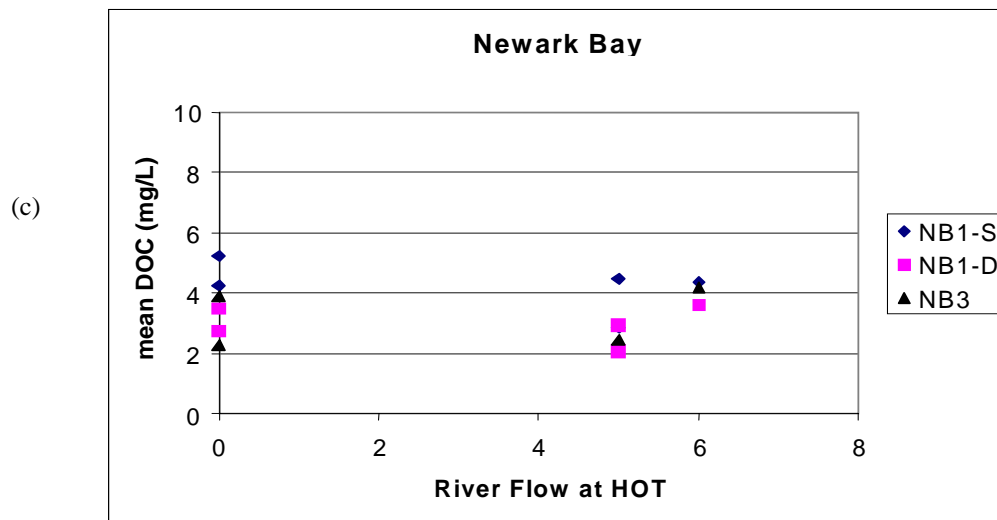
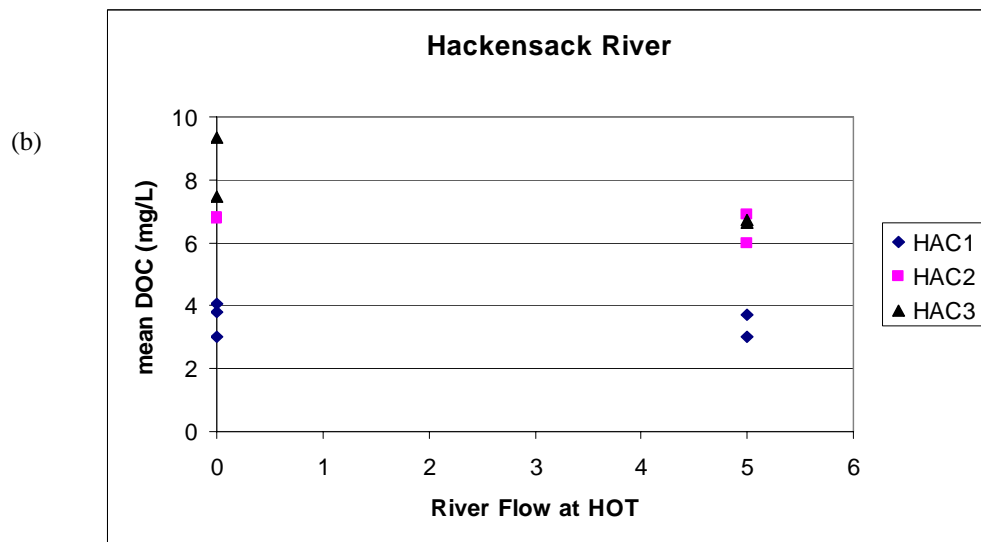
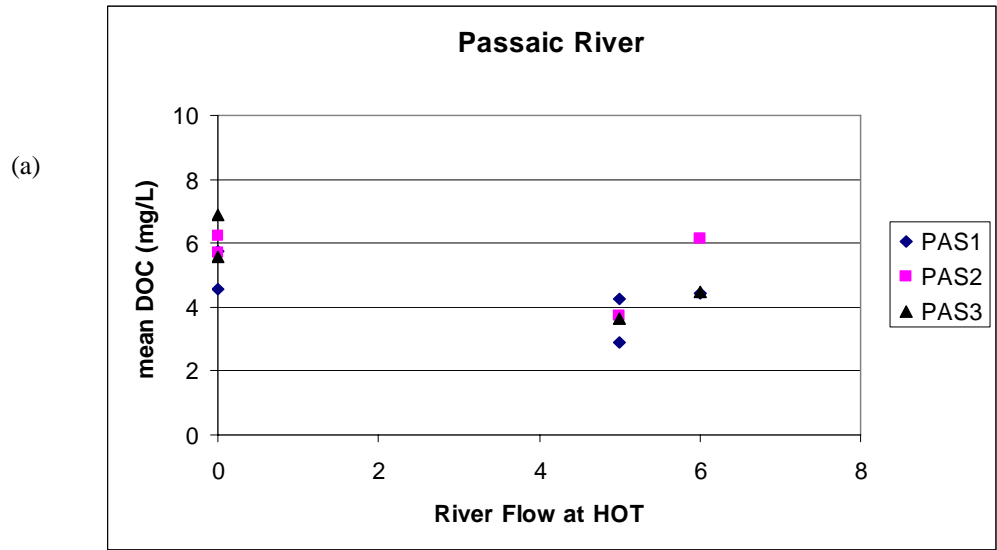
Figure 14 summarizes the mean wet and dry weather DOC sample results at all of the sampling stations. This figure suggests that mean DOC levels generally do not vary in response to changing river flow conditions.

Figure 15(a-e) shows the mean POC concentrations and  $f_{oc}$  ratios in the Passaic, Hackensack, Rahway, Elizabeth, and Raritan Rivers, and in Newark Bay, as a function of function of river flow conditions (i.e. storm magnitude, see Appendix A and Table 3). The Passaic River event river flow categorization was used for Newark Bay conditions.

Given the limited number of data points and the variability in the data, it is difficult to make any firm conclusions on wet vs. dry event trends. However, note the following general observations:

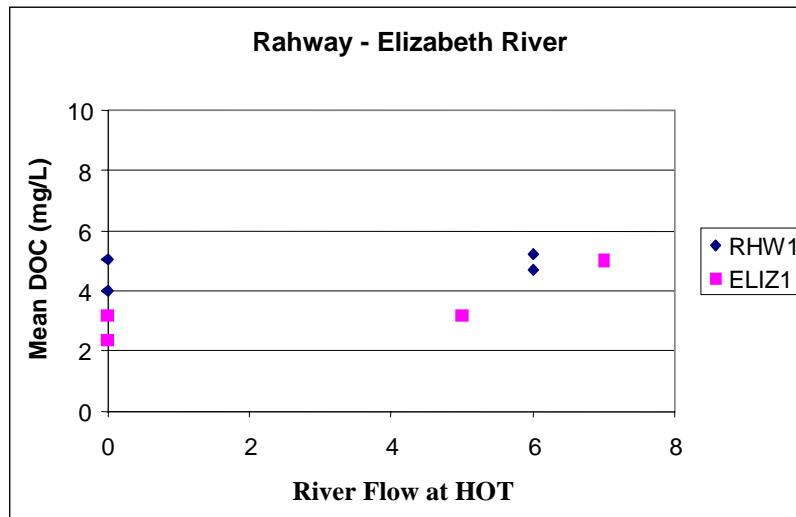
- the  $f_{oc}$  ratio in the Hackensack and Raritan Rivers, and Newark Bay, had greater variability during dry weather (baseflow) events compared to the wet weather events;
- the  $f_{oc}$  ratio tended to increase during wet weather events in the upper Passaic River (Station PAS3);
- the  $f_{oc}$  ratio tended to decrease during wet weather events in the Rahway River;
- POC tended to increase during wet weather events at Stations PAS1, HAC1, RAR1, and NB001-S.

Figures 16 and 17 summarize the mean wet and dry weather POC and  $f_{oc}$  sample results, respectively, at all of the sampling stations. These figures suggest that mean POC levels and  $f_{oc}$  ratios generally do not vary in response to changing river flow conditions.

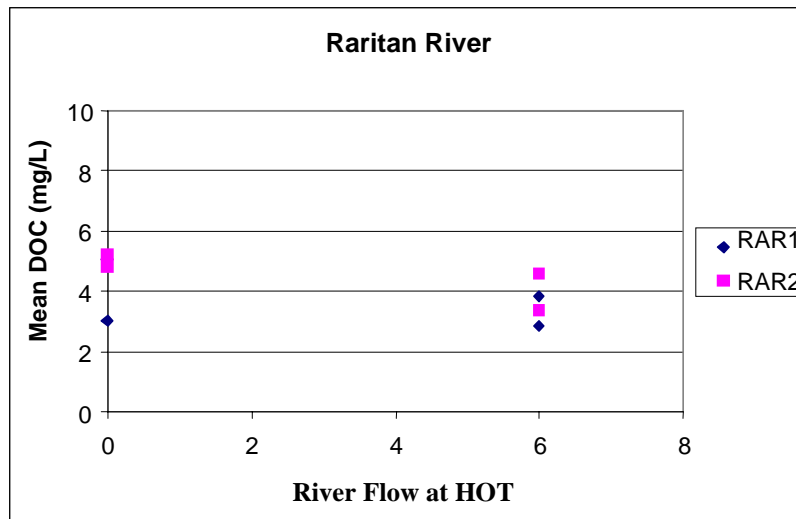


**Figure 13 (a–e):** Geometric Mean DOC Concentrations – Wet and Dry Sampling Events

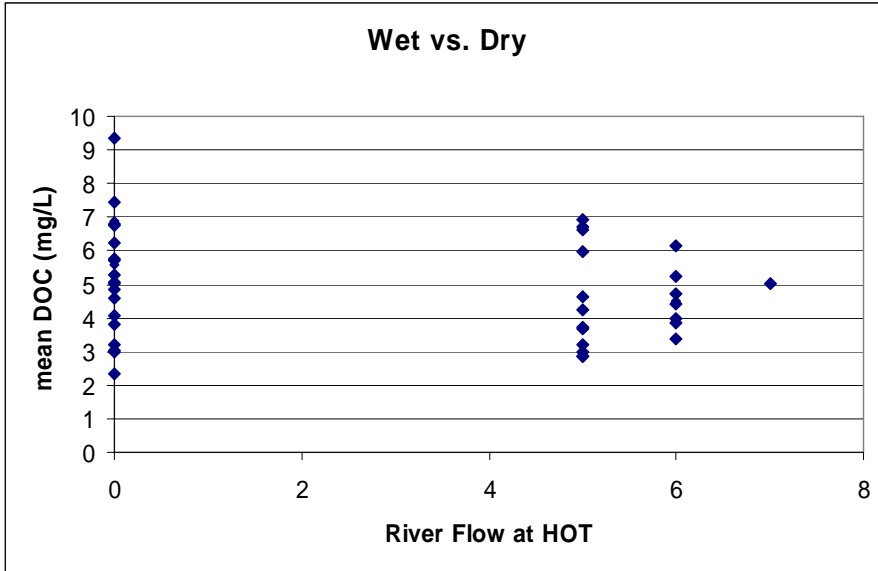
(d)



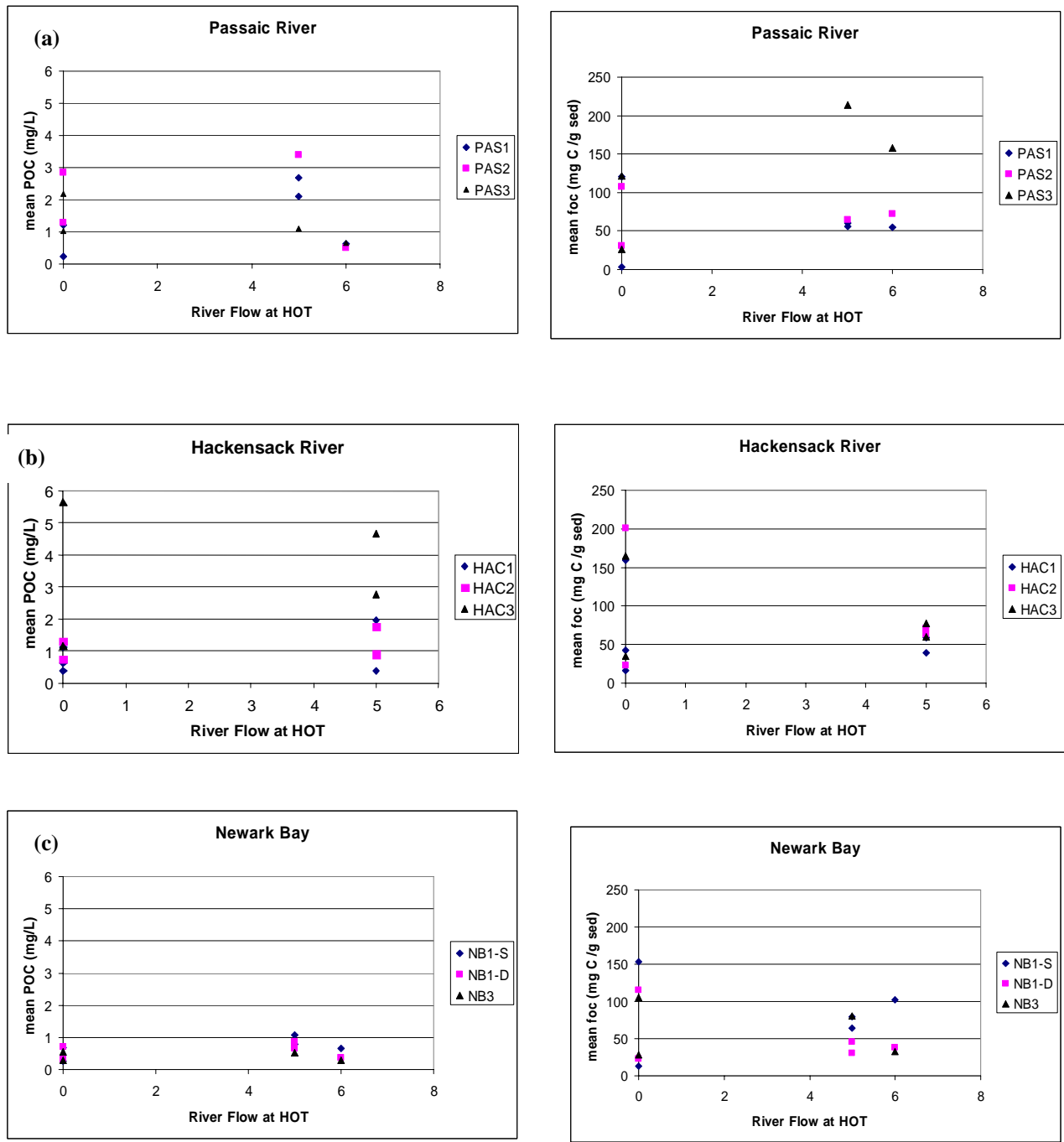
(e)



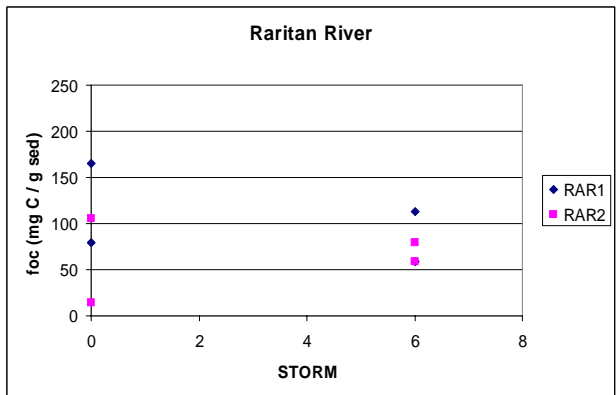
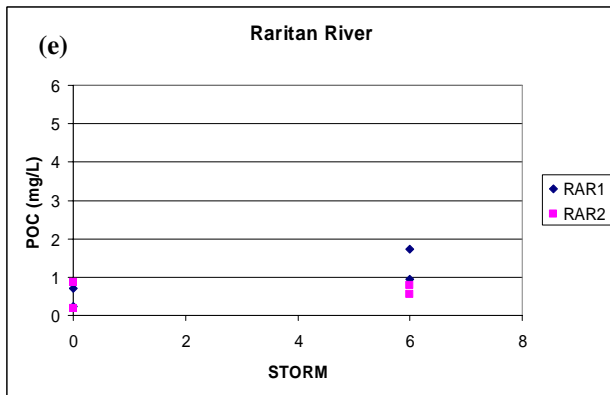
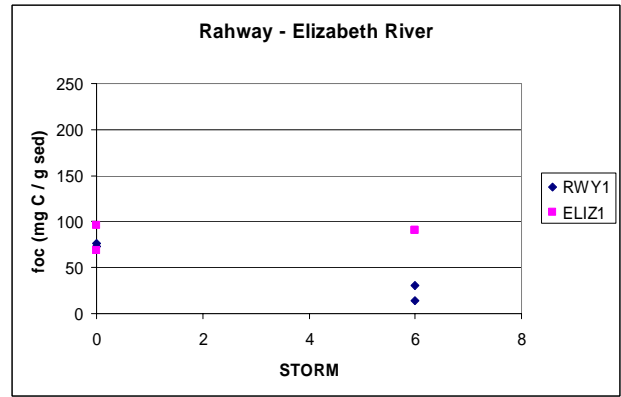
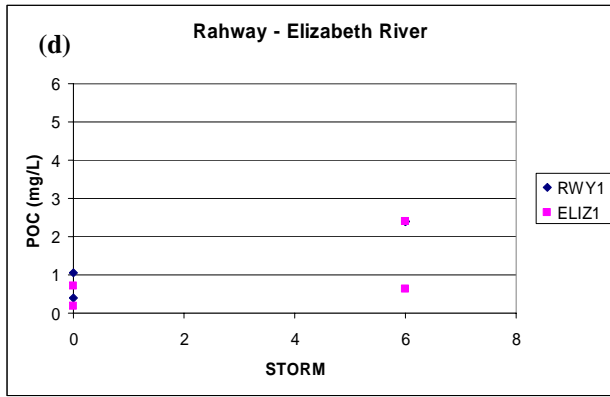
**Figure 13 (a–e):** Geometric Mean DOC Concentrations – Wet and Dry Sampling Events



**Figure 14:** Geometric Mean DOC Concentrations – Wet and Dry Sampling Events - at all of the sampling stations

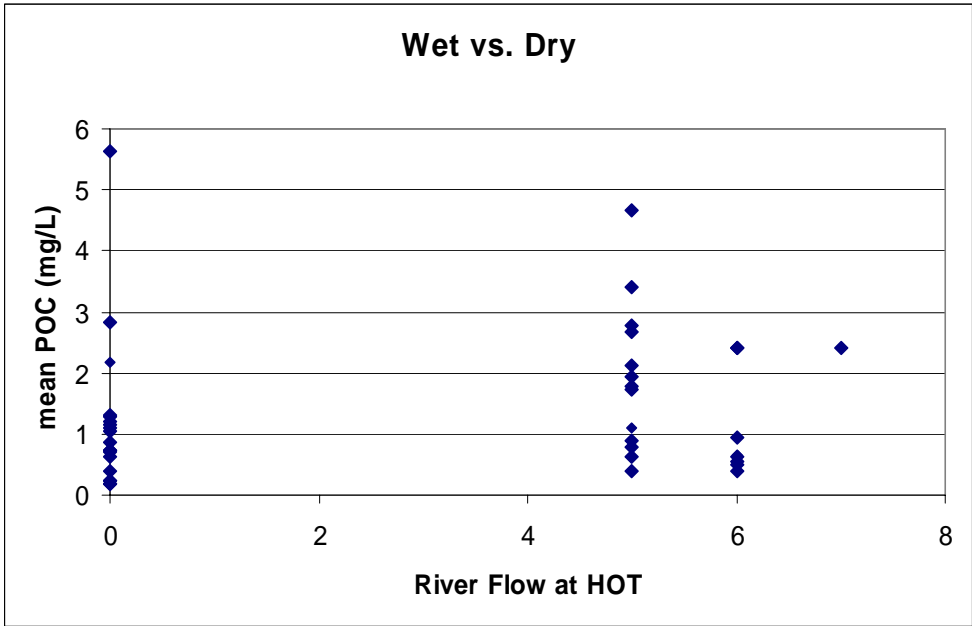


**Figure 15:** Geometric Mean POC Concentrations and  $f_{oc}$  ratios – Wet and Dry Sampling Events. (a) Passaic River, (b) Hackensack River, (c) Newark Bay, (d) Rahway and Elizabeth Rivers, (e) Raritan River.

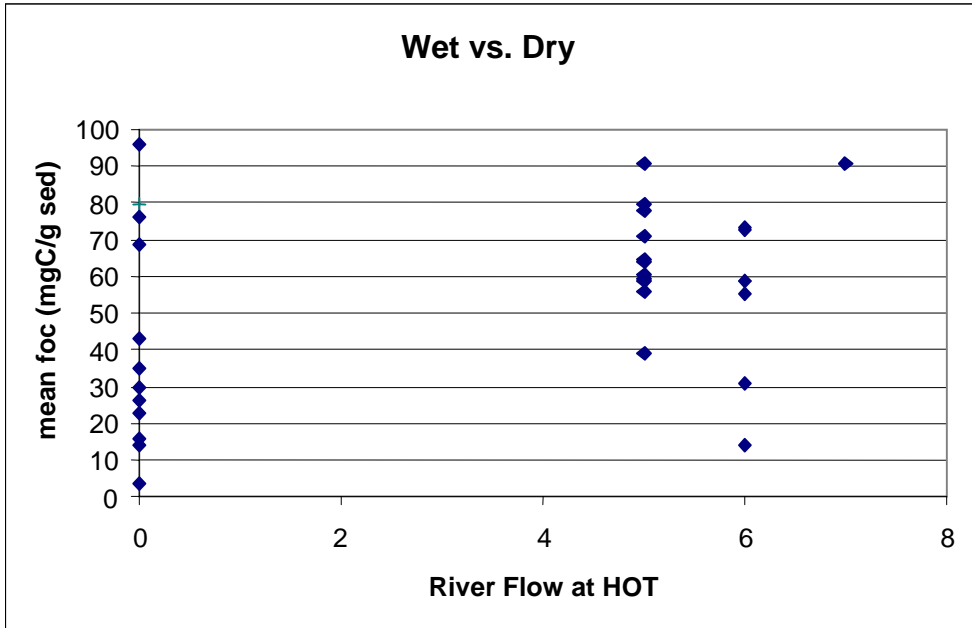


**Figure 15:** Geometric Mean POC Concentrations and foc ratios – Wet and Dry Sampling Events. (a) Passaic River, (b) Hackensack River, (c) Newark Bay, (d) Rahway and Elizabeth Rivers, (e) Raritan River.





**Figure 16:** Geometric Mean POC Concentrations – Wet and Dry Sampling Events at all of the sampling stations.

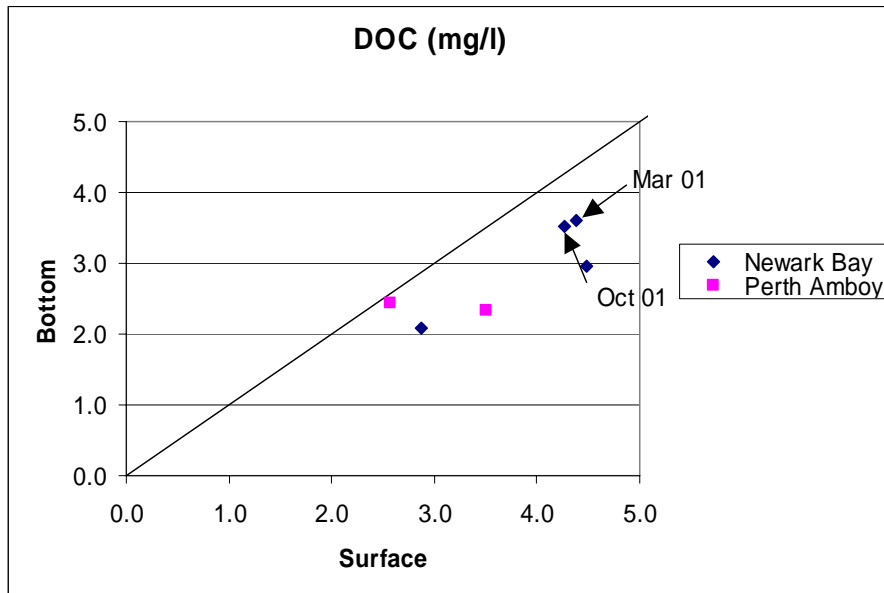


**Figure 17:** Geometric Mean  $f_{oc}$  ratios – Wet and Dry Sampling Events at all of the sampling stations

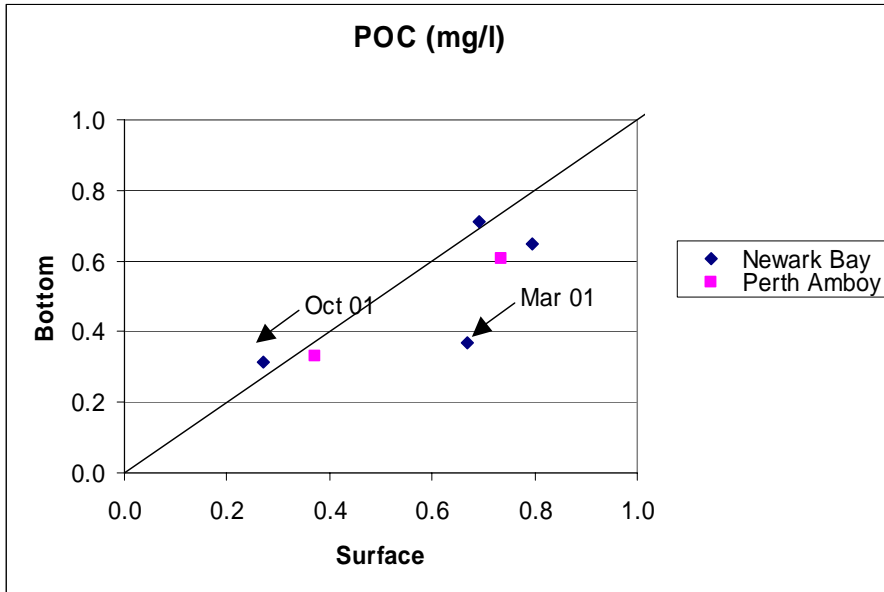
### 5.2.3 Surface vs. Bottom Samples

At Stations NB1 and PA, both surface (5ft below the surface) and bottom (5ft above the bottom) samples were collected. As shown in Figure 18, the surface samples at both stations usually had slightly higher DOC concentrations than the bottom samples. However, there was no clear trend in POC (see Figure 19).

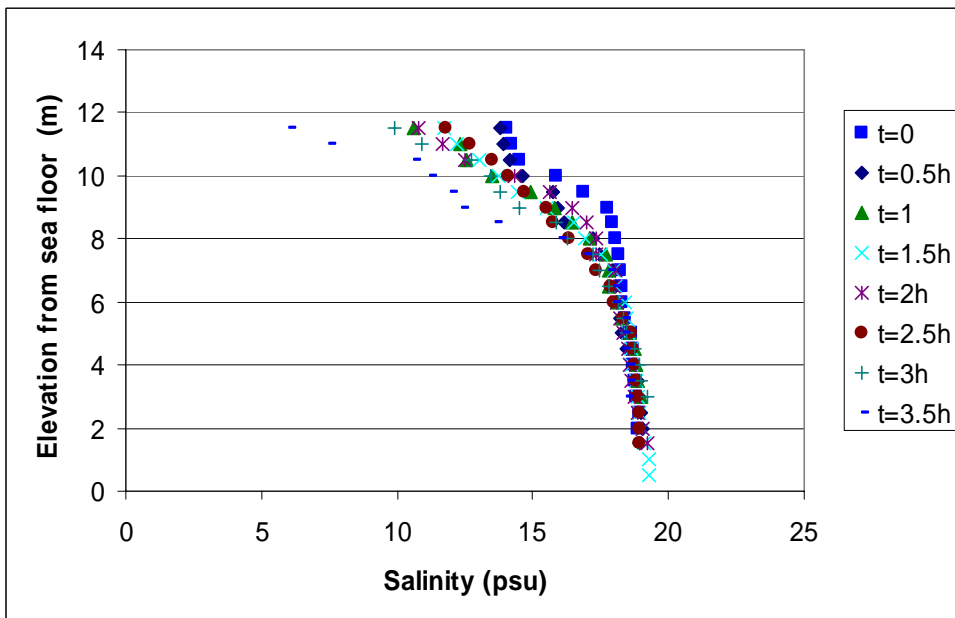
At Newark Bay Station NB001, there is a difference in POC (but not DOC) concentrations between the March 2001 (wet event) and October 2001 (dry event) samples. Figures 20, 21, and 22 show that there is salinity stratification with depth in the March 2001 event, but there is no stratification in the October 2001 event.



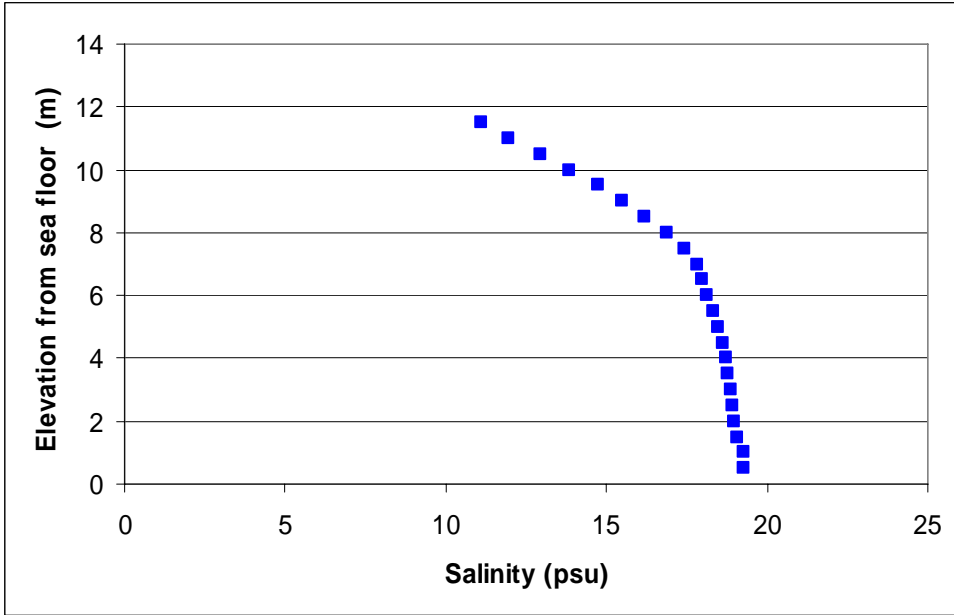
**Figure 18:** Geometric Mean DOC concentrations at Stations NB001 and PA - Surface vs. Bottom samples.



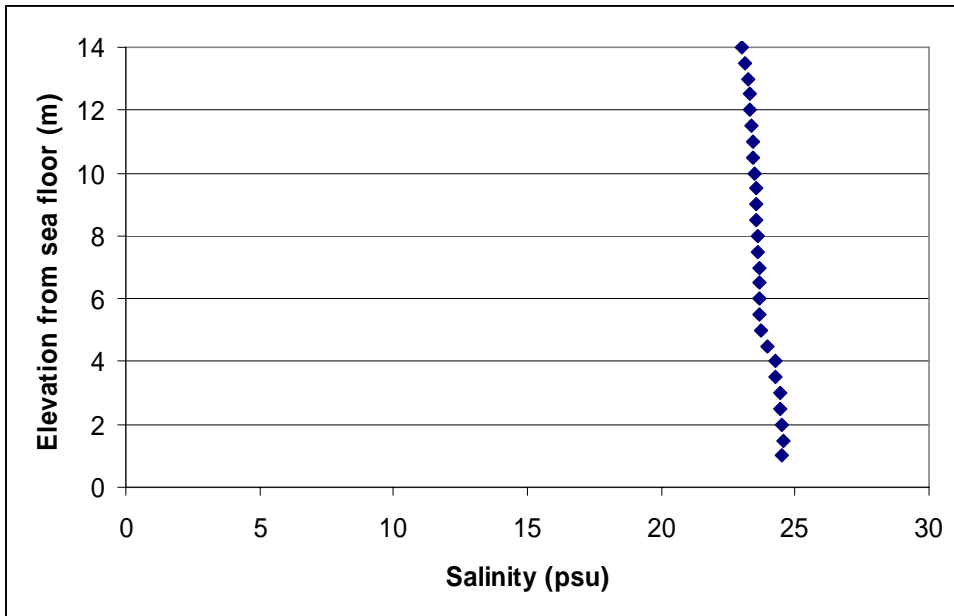
**Figure 19:** Geometric Mean POC concentrations at Stations NB001 and PA - Surface vs. Bottom samples.



**Figure 20:** Salinity Profiles at Station NB001 during the March 2001 sampling event.



**Figure 21:** Average Salinity Profile at Station NB001 in March 2001.



**Figure 22:** Average Salinity Profile at Station NB001 in October 2001.

### 5.3 Metals

#### 5.3.1 Sample Collection and Analysis

Grab samples for metals analyses were collected at all of the tidal river and estuary locations. They were analyzed for total and dissolved metals (Cd, Pb, Hg, and methyl-Hg) and represent instantaneous concentrations. The samples were collected at the start of the sampling event, at approximately slack high tide, and usually at a depth of 5 feet below the water surface. At some locations, grab samples were also collected at a height of 5 feet above the river/estuary bottom; these are noted with a “D” suffix (for example, NB1-D) to distinguish them from the surface samples (for example, NB1-S).

Samples were collected at sampling port 1 of the SIT-TOPS (see Figure 2) by pumping water directly into the sample bottles using USEPA methods (Frontier Geosciences SOP FGS-008.3, “Ultra-Clean Aqueous Sample Collection”, revised 4/15/01). The samples were analyzed by Frontier Geosciences (Seattle, WA) using the methods listed in Table 12. The mean Method Detection Limits (MDLs) achieved for all of the samples have also been included in Table 12. Sample data reported by the analytical laboratory were corrected (by subtraction) for laboratory blanks.

**Table 12:** NJTRWP Metals Analytical Methods and Method Detection Limits (MDLs)

Analyte	Method	Mean MDL (ng/L)
Cadmium (Cd)	USEPA 1638	2.35
Lead (Pb)	USEPA 1638	10.22
Mercury (Hg)	Mod USEPA 1631b	0.10
methyl-Mercury (met-Hg)	Mod USEPA 1630	0.017

#### 5.3.2 NJTRWP Blank Correction

The sample data was subjected to a preliminary Quality Assurance Verification Review. In addition, because of the nature of the samples and the trace concentrations expected for the target metals, the NJTRWP “maximum blank” correction procedure described in Section 4.3 was applied to the sample data. Beginning with some of the fall 2001 surveys, a notable increase in Equipment Blank contamination for some dissolved metals (in particular, Cd and Pb) was observed. The probable cause for this contamination was the dedicated length of Teflon tubing used to collect the metals Equipment Blanks. In response to this, an alternative procedure was developed to blank correct those samples potentially “impacted” by the contaminated Equipment Blanks – the mean of the “uncontaminated” Equipment Blanks was used. This is discussed in the NJDEP document “QA Issue: SIT Dissolved Metals Blank Contamination (January 10, 2003)”, included as Appendix B.

Table 13 shows the number of samples censored (i.e. “not useable”) as a result of using the NJTRWP “5X Maximum Blank Approach”. About 90% of the tidal river and estuary dissolved Hg data was impacted by Equipment Blank contamination using the NJTRWP “5X Maximum Blank Approach”. Further analyses suggested this approach might have been too conservative, resulting in numerous “false negatives”. In contrast, about 90% of the SIT dissolved Hg data was useable when a “maximum blank” subtraction approach was used, in conjunction with more detailed analyses of the blanks, and that approach was adopted. This is discussed in the NJDEP document “QA Issue: SIT Phase I Dissolved Hg Data - Blank Contamination Impacts (Draft, April 2, 2004)”, included as Appendix C.

**Table 13:** Number of NJTRWP SIT Ambient Water Quality Samples Censored as a Result of Blank Contamination Using the NJTRWP “5X Maximum Blank Approach”

Analyte	Tributary/Estuary
Total # Samples	n=76
Total Cd	0
Dissolved Cd	0
Total Pb	0
Dissolved Pb	5
Total Hg	2
Dissolved Hg	67
Total met-Hg	0 (n=11)
Dissolved met-Hg	27 (n=67)

### 5.3.3 Cadmium (Cd)

#### 5.3.3.1 Measurements

Tables 14 and 15 show dissolved Cd (ng/L) and Total Cd (ng/L), respectively, as well as the overall arithmetic mean and standard deviation of this data, in the ambient water grab samples at all sampling stations during all sampling events.

Mean concentrations of Total Cd (see Figures 23 and 26, and Table 15) were relatively similar throughout the harbor. Mean Total Cd was lower in the Raritan River (particularly at Station RAR2, mean = 39.7 ng/L) and at Station PA-D (mean = 76.1 ng/L). The mean concentration was elevated in the Rahway River (Station RWY1 = 168.7 ng/L). Likewise, mean dissolved Cd concentrations were similar at all of the sampling stations (see Figures 24 and 27, and Table 14), except for lower mean concentrations in the upper Raritan River (Station RAR2 mean = 21.7 ng/L) and upper Hackensack River (Station HAC3 mean = 40.5 ng/L).

Over all sampling stations and sampling events, there was a slight correlation between Total Cd and SS (Total Cd [ng/L] = 1.53\*SS [mg/L] + 94; r = 0.438). The highest Total and dissolved Cd concentrations in the Northern Tributaries (Passaic and Hackensack Rivers, Newark Bay) were

measured in the December 2000 sampling event. In the Southern Tributaries (Elizabeth and Rahway Rivers, Arthur Kill), no single sampling event consistently had the highest Total or dissolved Cd at all/most of the stations.

**Table 14:** Dissolved Cd Concentration (ng/L)

	6/20- 22/00	12/13- 15/00	3/13- 15/01	4/12/01	4/25/01	5/15/01	5/24/01	10/17- 19/01	10/3/01	11/6/01	3/12- 14/02	3/27/02	5/14/02	Mean	Std. Dev.
<b>PAS1</b>	1.5	144.0	48.0					83.0						69.1	60.1
<b>PAS2/ PAS2a</b>		*61.0	74.6					52.1						62.6	11.3
<b>PAS3</b>		146.0	65.3					55.7						89.0	49.6
<b>NB1-S</b>	96.4	162.0	53.5					78.0						97.5	46.5
<b>NB1-D</b>	1.5	165.0	66.5					81.7						78.7	67.3
<b>NB3</b>		176.0	72.4					80.8						109.7	57.5
<b>AK1-S</b>		182.0	63.5		53.4		65.7			140.0			105.0	101.6	51.0
<b>AK1-D</b>					50.7		70.9			132.0			98.1	87.9	35.2
<b>PA-S</b>		185.0	64.6				59.1			74.9				95.9	59.8
<b>PA-D</b>					42.8		120.0			80.0				80.9	38.6
<b>HAC1</b>	109.0	157.0	60.7					86.0			105.0			103.5	35.5
<b>HAC2</b>		113.0	49.9					171.0			85.2			104.8	51.1
<b>HAC3</b>		55.6	34.3					29.3			42.8			40.5	11.5
<b>KVK1</b>		166.0	55.1					74.6			103.0			99.7	48.4
<b>RAR1-S</b>				41.7		49.4			145.0			57.8		73.5	48.1
<b>RAR1-D</b>				46.0		42.7			121.0			59.0		67.2	36.6
<b>RAR2</b>				23.8		20.0			24.2			18.6		21.7	2.8
<b>RWY1</b>					53.1		14.6			149.0			86.2	75.7	56.9
<b>ELIZ1</b>					50.7		32.0			127.0			77.0	71.7	41.2

\* The December 2000 sample was collected at Station PAS2 while construction activities were underway just upstream; all other samples were collected at Station PAS2a.

**Table 15: Total Cd Concentration (ng/L)**

	6/20-22/00	12/13-15/00	3/13-15/01	4/12/01	4/25/01	5/15/01	5/24/01	10/17-19/01	10/3/01	11/6/01	3/12-14/02	3/27/02	5/14/02	Mean	Std. Dev.
<b>PAS1</b>	114.0	175.0	80.4					152.0						130.4	41.7
<b>PAS2/ PAS2a</b>		*	110.0					178.0						144.0	48.1
<b>PAS3</b>		182.0	74.2					165.0						140.4	58.0
<b>NB1-S</b>	114.0	159.0	68.3					91.3						108.2	38.7
<b>NB1-D</b>	138.0	165.0	80.7					87.3						117.8	40.6
<b>NB3</b>		183.0	75.4					84.5						114.3	59.7
<b>AK1-S</b>		241.0	84.3		72.7		118.0			129.0			119.0	127.3	59.9
<b>AK1-D</b>					73.0		104.0			126.0			103.0	101.5	21.8
<b>PA-S</b>		196.0	82.2				69.5			80.1				107.0	59.6
<b>PA-D</b>					71.1		62.6			94.5				76.1	16.5
<b>HAC1</b>	131.0	204.0	88.3					127.0			122.0			134.5	42.4
<b>HAC2</b>		185.0	126.0					129.0			105.0			136.3	34.2
<b>HAC3</b>		118.0	138.0					122.0			243.0			155.3	59.1
<b>KVK1</b>		164.0	63.8					81.6			101.0			102.6	43.7
<b>RAR1-S</b>				76.6		68.4			121.0			66.8		83.2	25.6
<b>RAR1-D</b>				65.9		71.6			121.0			65.8		81.1	26.8
<b>RAR2</b>				48.4		53.2			26.7			30.6		39.7	13.0
<b>RWY1</b>					82.9		140.0			201.0			251.0	168.7	73.0
<b>ELIZ1</b>					67.6		297.0			119.0			104.0	146.9	102.4

\* The December 2000 sample was collected at Station PAS2 while construction activities were underway just upstream; all other samples were collected at Station PAS2a. Omitted because of a very high value due to this construction.

The coefficient of variation of the Total Cd concentrations ranged between 0.214 and 0.558 (except for ELIZ1 = 0.697), with all but four values less than 0.45. The coefficient of variation was generally higher for the dissolved Cd data (range = 0.181 to 0.869, except for RAR2 = 0.128 and PAS2 = 0.181), with all but five values greater than 0.45.

Dissolved Cd ranged between 0.8 and 192% of the Total Cd (values > 100% are due to analytical variance), with a mean and standard deviation of  $68.4 \pm 34.4\%$ . Of the 74 blank corrected Total/Dissolved Cd samples, 9 had dissolved Cd < 18% (6 of these were  $\leq 1\%$ ), and 65 were  $\geq 25\%$  dissolved Cd (9 of these were  $\geq 100\%$ ). Twelve of the 19 sampling stations had a Total Cd sample that was either  $\leq 1\%$  or  $\geq 100\%$  dissolved Cd.



Figure 25 shows examples of the partitioning of the Total Cd into dissolved and suspended sediment fractions. The relatively high percentage of dissolved Cd in the samples probably accounts for the generally comparable levels of this metal throughout the study area.

Table 16 shows the suspended sediment Cd (ng/g sed) data, as well as the overall arithmetic mean and standard deviation of this data, in the ambient water grab samples at all sampling stations during all sampling events.

Mean concentrations of suspended sediment Cd were typically higher in the tributaries (2,357 – 4,667 ng/g sed) compared to the estuarine areas of the harbor (505 – 1,528 ng/g sed). However, as was true for mean Total Cd (ng/L) concentrations, suspended sediment Cd was lower in the Raritan River (RAR2 mean = 1,274 ng/sed, RAR1-S mean = 834 ng/sed). In contrast, however, mean suspended sediment Cd levels were elevated and comparable to the concentrations in the tributaries at the Arthur Kill Stations (2,472 – 3,262 ng/g sed).

The coefficient of variation of the suspended sediment Cd concentrations ranged between 0.007 and 0.740 (except for NB1-D = 1.52 and NB3 = 1.16).

**Table 16: Suspended Sediment Cd Concentration (ng/g sed)**

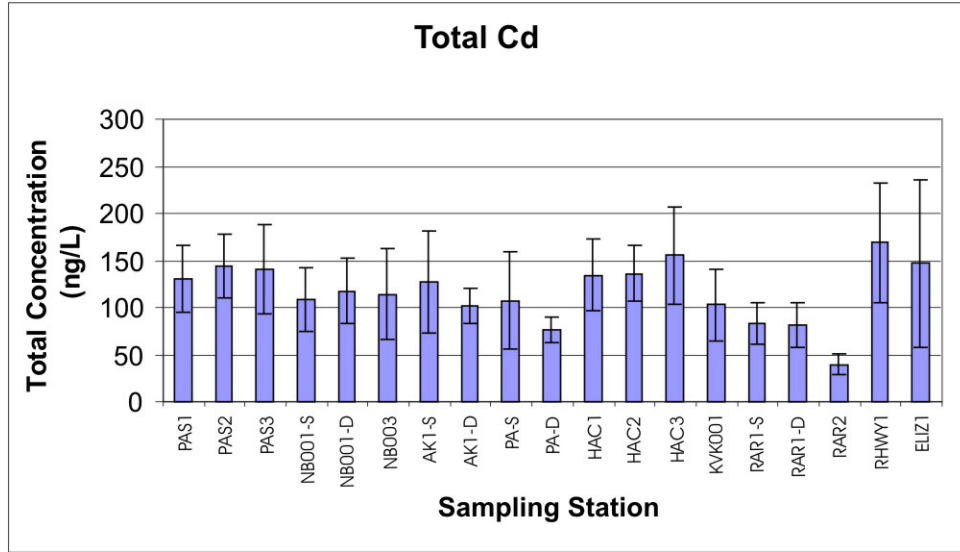
	6/20- 22/00	12/13- 15/00	3/13- 15/01	4/12/01	4/25/01	5/15/01	5/24/01	10/17- 19/01	10/3/01	11/6/01	3/12- 14/02	3/27/02	5/14/02	Mean	Std. Dev.
<b>PAS1</b>	4247	1092	2842					1880						2515	1358
<b>PAS2</b>		*													
<b>PAS2a</b>			3576					1256						2416	1640
<b>PAS3</b>		5902	1745					1904						3184	2355
<b>NB1-S</b>	1173	NC	1973					1985			204			1334	844
<b>NB1-D</b>	5643	71	940					691			294			1528	2325
<b>NB3</b>		1373	337					194			118			505	585
<b>AK1-S</b>		5175	1926		NA		NA			NA			2917	3339	1665
<b>AK1-D</b>					3279		3245			NC			NA	3262	24
<b>PA-S</b>		1774	1492				832			912				1253	455
<b>PA-D</b>					1791		NC			3152				2472	962
<b>HAC1</b>	982	2017	2629					4059			2099			2357	1123
<b>HAC2</b>		2618	3145					NC			1904			2556	623
<b>HAC3</b>		1793	3211					2888			5769			3415	1683
<b>KVK1</b>		NC	946					722			NC			834	158
<b>RAR1-S</b>				4106		2794			NC			1364		2755	1372
<b>RAR2</b>				1720		2128			156			1091		1274	859
<b>RWY1</b>					2614		3455			9286			3075	4607	3138
<b>ELIZ1</b>					1988		8030			NC			3971	4663	3080

\* The December 2000 sample was collected at Station PAS2 while construction activities were underway just upstream; all other samples were collected at Station PAS2a. Omitted because of a very high value due to this construction.

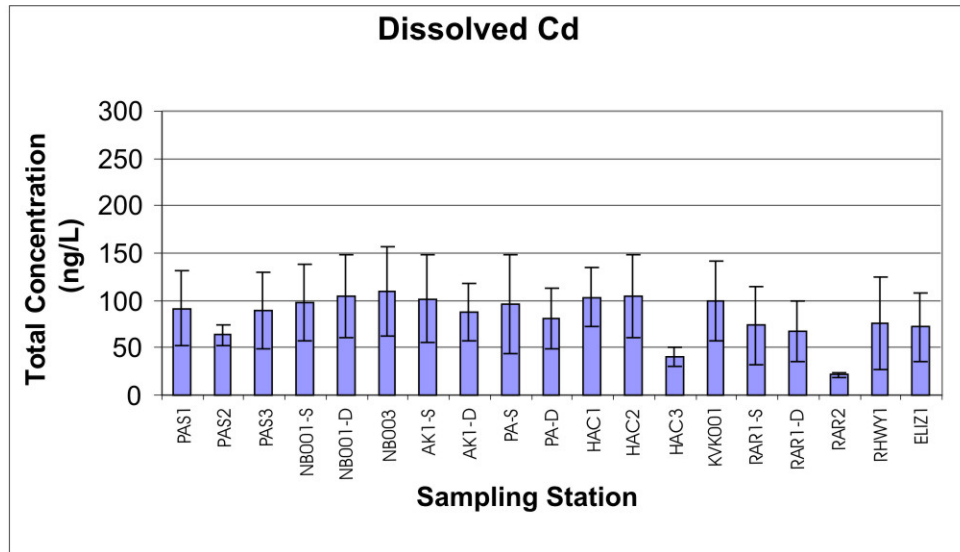
Note: NC = not calculated (dissolved Cd > Total Cd)

NA = not available (no associated SS data)

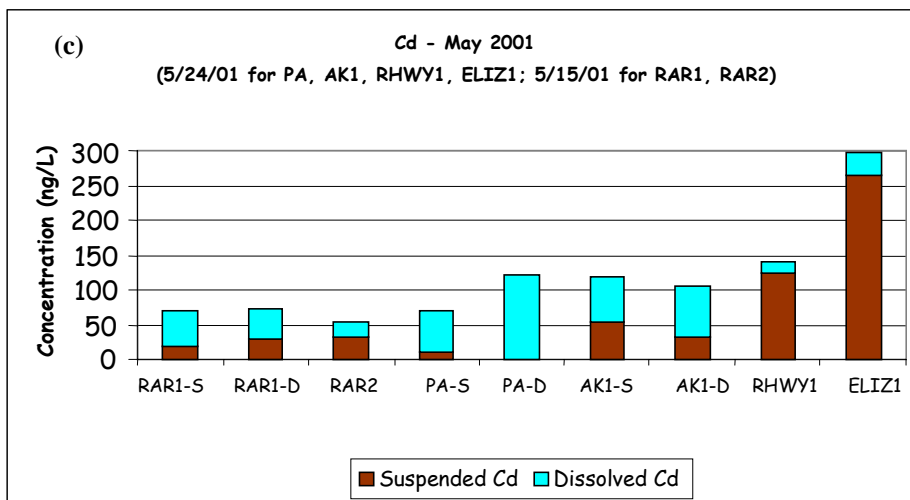
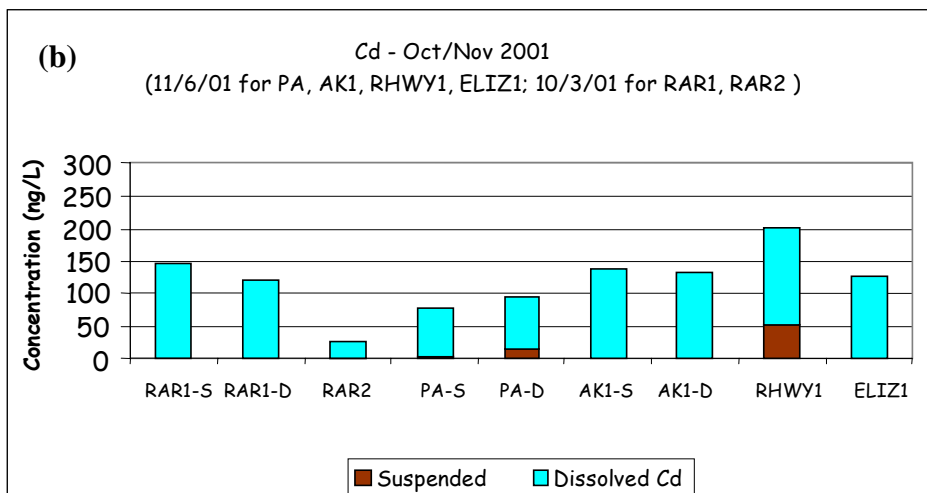
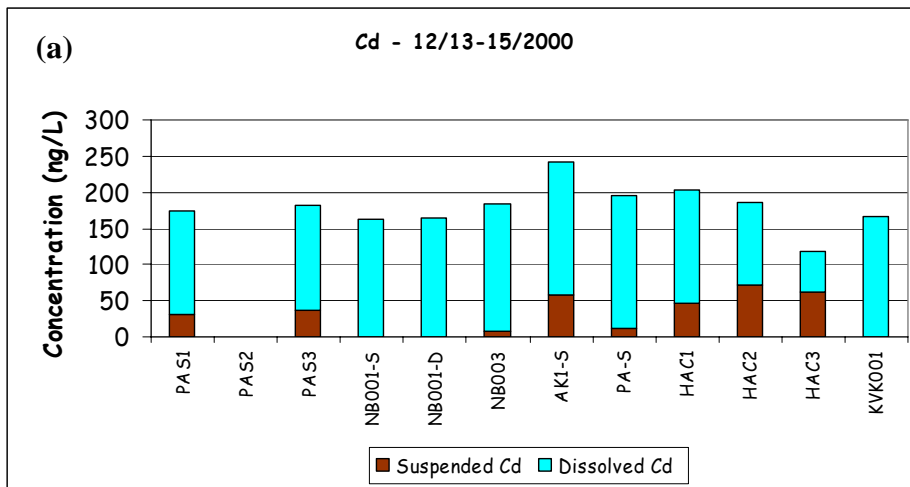
All Station RAR1-D samples were "NA" (data not shown)



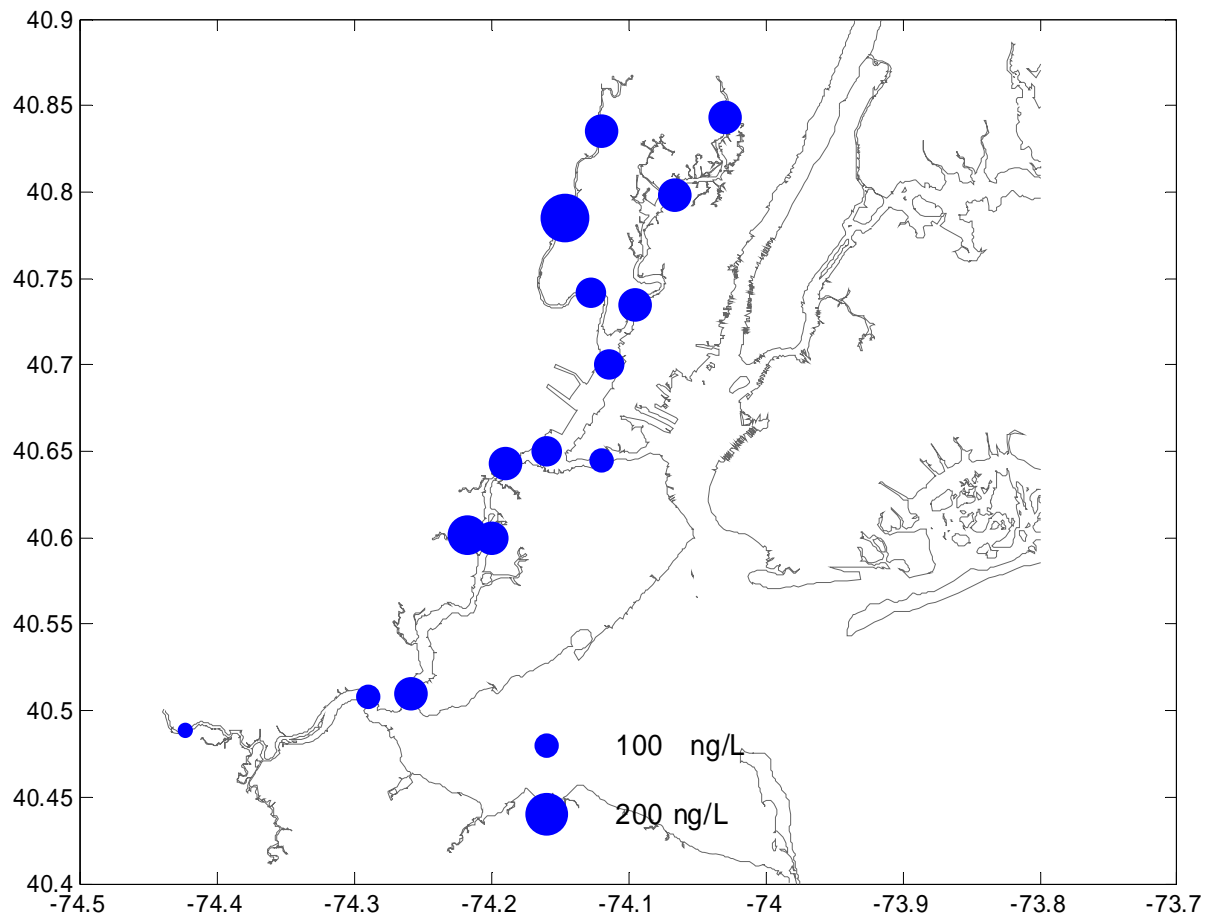
**Figure 23:** Mean  $\pm$  standard deviation of Total Cd concentration at each sampling station.



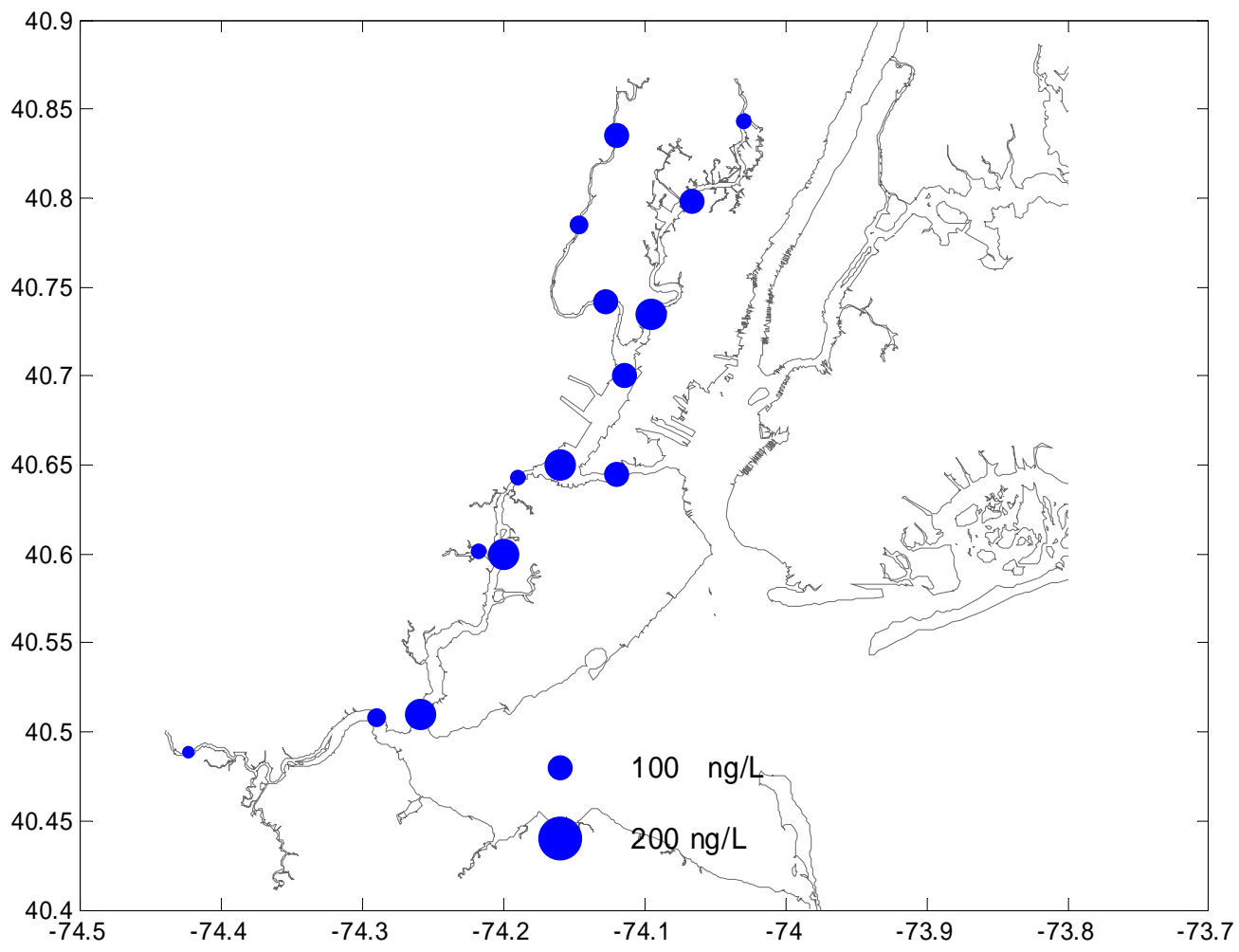
**Figure 24:** Mean  $\pm$  standard deviation of dissolved Cd concentration at each sampling station.



**Figure 25:** Cd partitioning between the dissolved and suspended phases in the (a) Dec 2000, (b) Oct/Nov 2001, and (c) May 2001 sampling events.



**Figure 26:** Mean Total Cd concentration at each sampling station (ng/L).

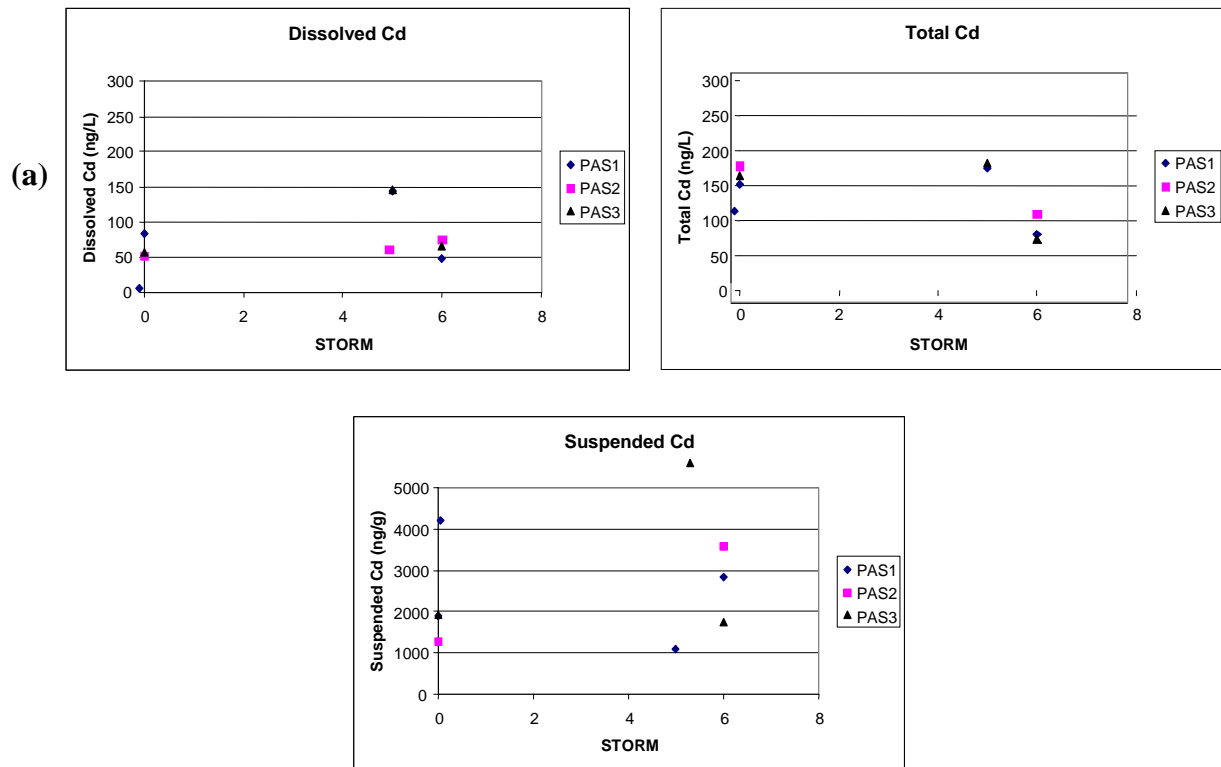


**Figure 27:** Mean Dissolved Cd concentration at each sampling station (ng/L).

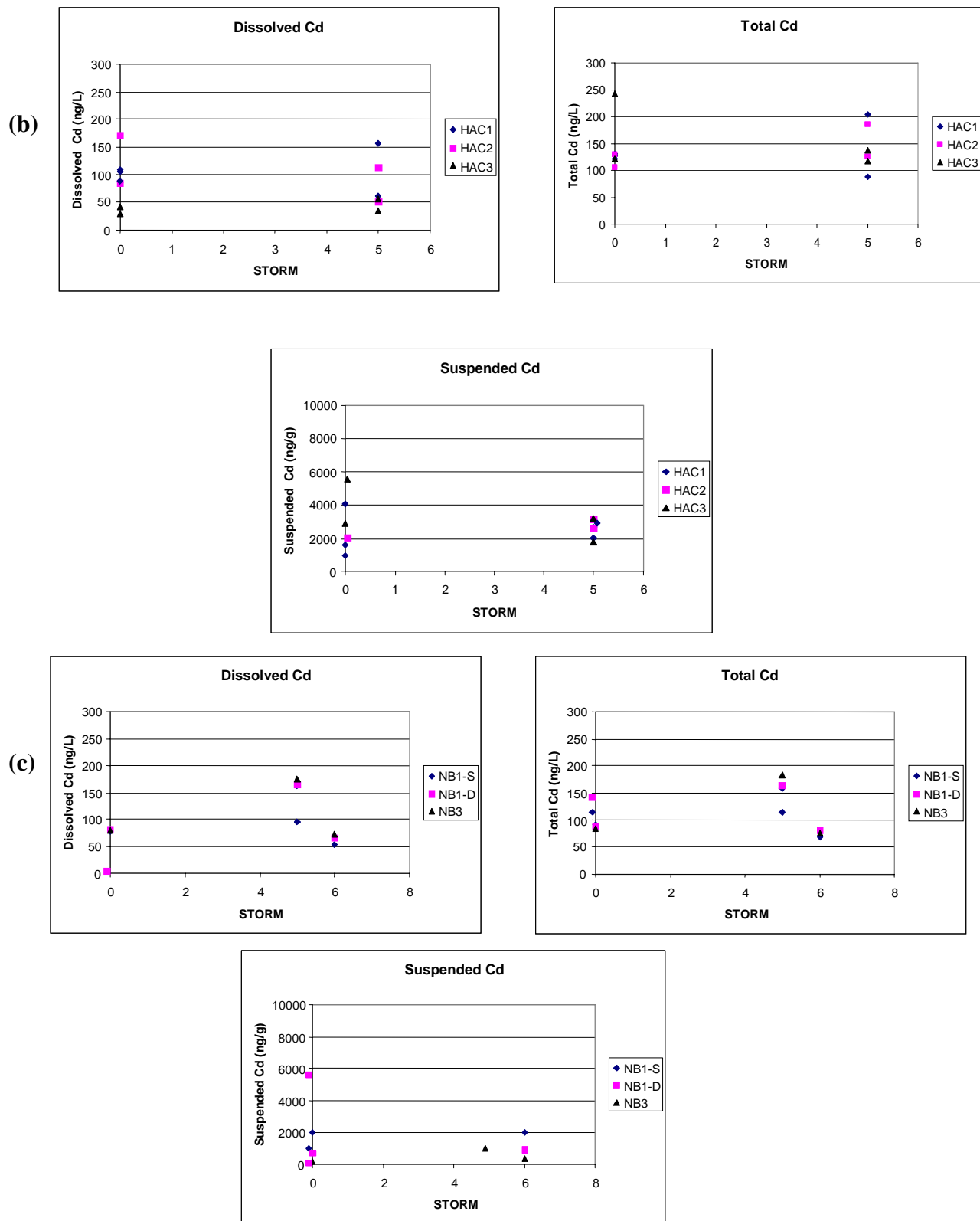
### 5.3.3.2 Wet vs. Dry Events

Figure 28(a-e) shows dissolved Cd (ng/L), Total Cd (ng/L), and Suspended Sediment Cd (ng/g sed) concentrations at all sampling stations (except Stations KVK001, AK1, and PA) as a function of river flow conditions (i.e. storm magnitude, see Appendix A and Table 3). Given the limited number of data points and the variability in the data, it is difficult to make any firm conclusions on wet vs. dry event trends. However, note the following general observations:

- Dissolved Cd concentration did not appear to vary consistently with river flow at any of the sampling stations;
- Total Cd concentration did not vary with river flow, except in the Elizabeth and Rahway Rivers, where it tended to be greater during wet weather events (Figure 28d);
- Suspended Sediment Cd concentration did not vary with river flow, except in the Elizabeth and Rahway Rivers (Figure 28d), and the Raritan River (Figure 28e), where it tended to be greater during wet weather events.

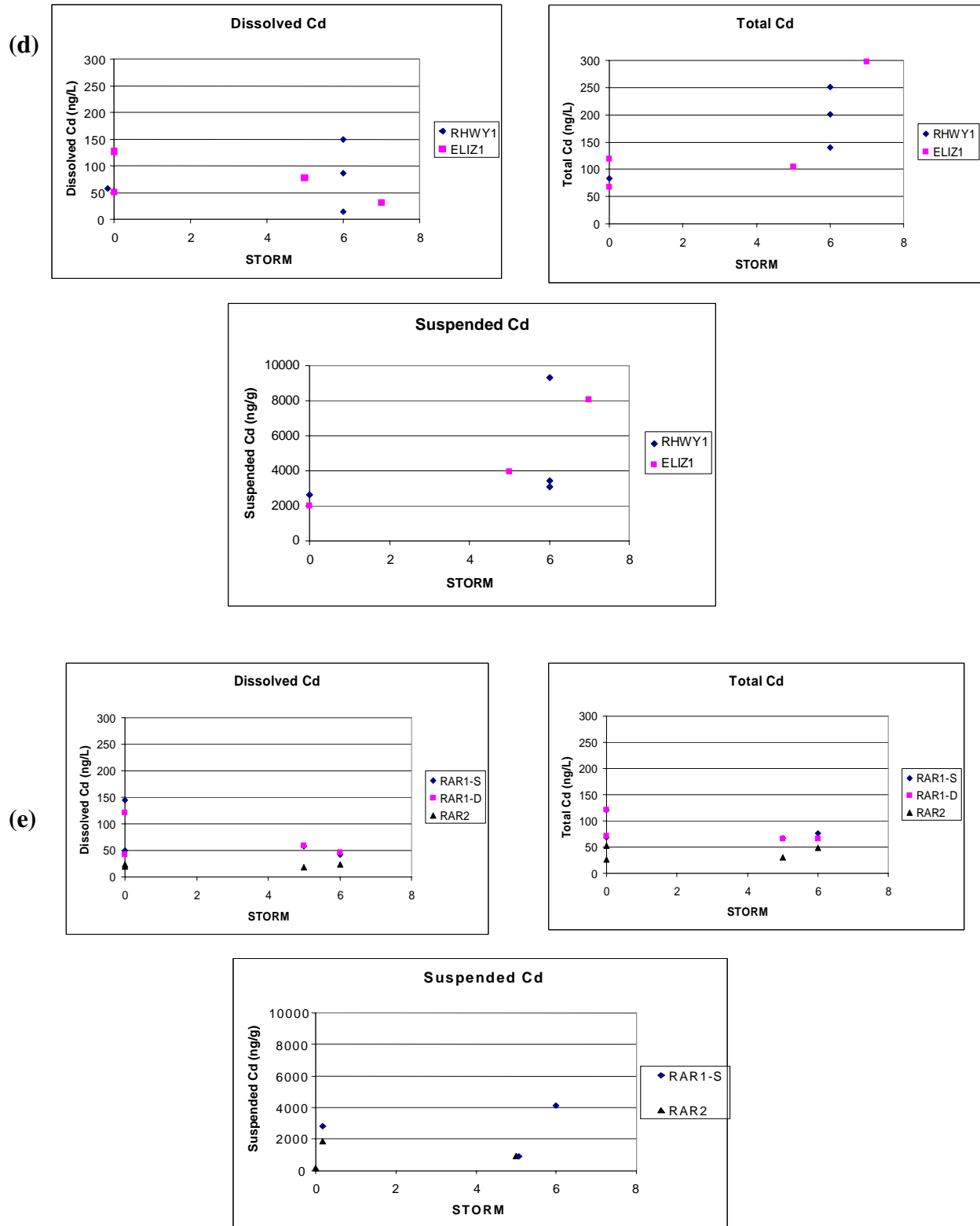


**Figure 28(a-e):** Dissolved Cd (ng/L), Total Cd (ng/L) and Suspended Sediment Cd (ng/g sed) Concentrations – Wet and Dry Sampling Events. (a) Passaic River, (b) Hackensack River, (c) Newark Bay, (d) Elizabeth and Rahway Rivers, (e) Raritan River.



**Figure 28(a-e):** Dissolved Cd (ng/L), Total Cd (ng/L) and Suspended Sediment Cd (ng/g sed) Concentrations – Wet and Dry Sampling Events. (a) Passaic River, (b) Hackensack River, (c) Newark Bay, (d) Elizabeth and Rahway Rivers, (e) Raritan River.

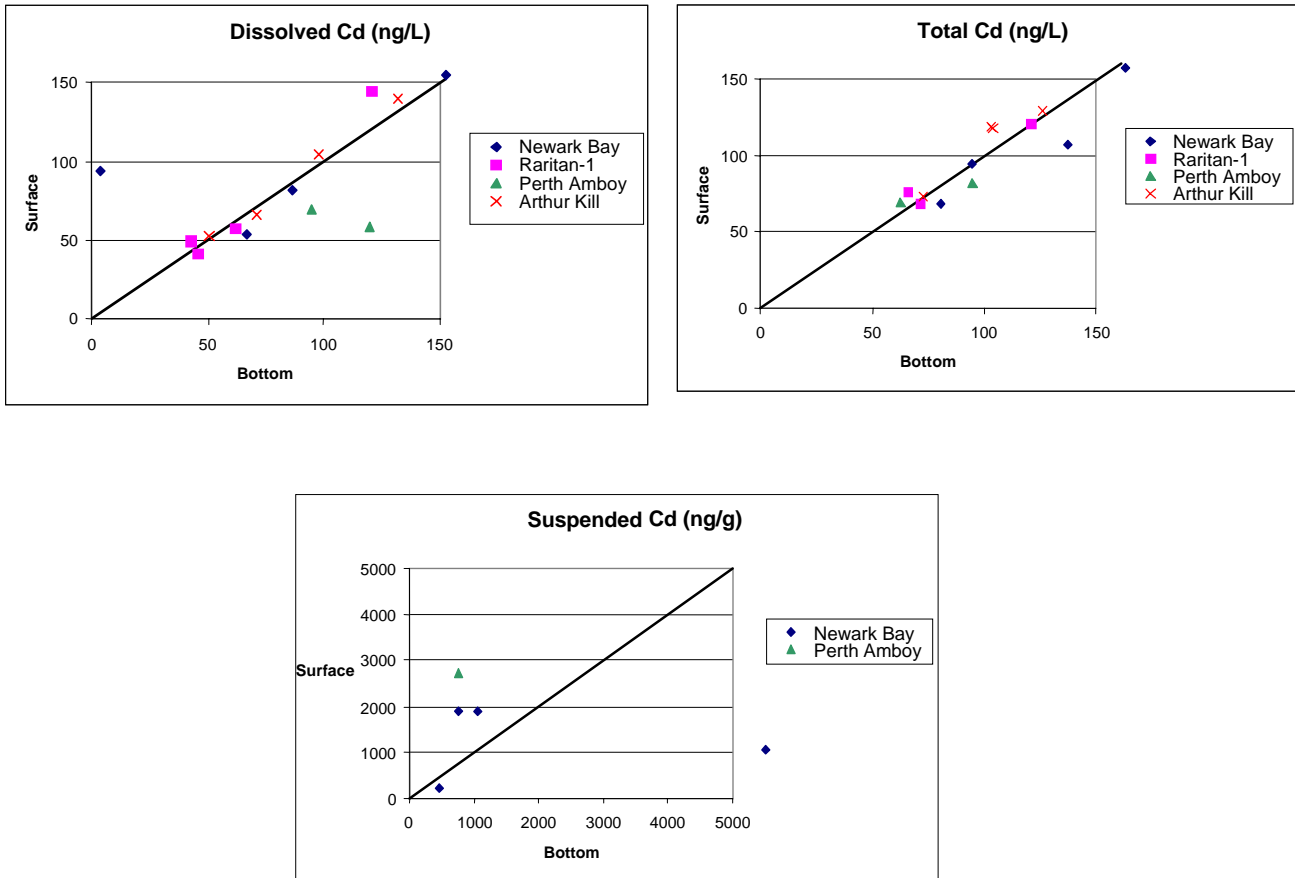




**Figure 28(a-e):** Dissolved Cd (ng/L), Total Cd (ng/L) and Suspended Sediment Cd (ng/g sed) Concentrations – Wet and Dry Sampling Events. (a) Passaic River, (b) Hackensack River, (c) Newark Bay, (d) Elizabeth and Rahway Rivers, (e) Raritan River.

### 5.3.3.3 Surface vs. Bottom Samples

At Stations NB1, PA, RAR1, and AK1, both surface (5 feet below the surface) and bottom (5 feet above the bottom) samples were taken. As shown in Figure 29, no trends in the data were observed.



**Figure 29:** Surface vs. Bottom Samples (a) Dissolved Cd, (b) Total Cd, and (c) Suspended Sediment Cd concentrations.

### 5.3.4 Lead (Pb)

#### 5.3.4.1 Measurements

Table 17, Table 18, and Table 19 present the Total Pb (ng/L), dissolved Pb (ng/L) and suspended sediment Pb (ng/g sed) concentrations, respectively, as well as the overall arithmetic mean and standard deviation of this data.

The highest mean Total Pb concentrations (>6,000 ng/L; see Figure 30) were measured in the tributaries, particularly in the Rahway (6,890 ng/L) and Elizabeth (10,898 ng/L) Rivers, the upper Hackensack River (Station HAC3, 7,965 ng/L), and the mid/upper Passaic River (Station PAS2 = 9,205 ng/L, Station PAS3 = 6,103 ng/L). However, the Elizabeth River mean Total Pb concentration may be skewed by a single sample result (see below). Mean Total Pb concentrations at the estuarine and Raritan River stations were all less than 3,120 ng/L.

The highest mean dissolved Pb concentrations ( $\geq 1,000$  ng/L; see Figure 31) were measured at Stations PAS2 (930 ng/L), PA-S (1,404 ng/L), HAC2 (1,048 ng/L) and RAR1-S (1,080 ng/L). However, the Station RAR1-S dissolved Pb concentration may be skewed by a single sample result in October 2001. Mean dissolved Pb concentrations at the other stations were all less than 725 ng/L.

Over all sampling stations and sampling events, there was a moderate correlation between Total Pb and SS (Total Pb [ng/L] =  $203 \cdot \text{SS [mg/L]} + 819$ ;  $r = 0.618$ ). However, omitting one data point – the Elizabeth River May 2001 sample – significantly improves the Total Pb:SS correlation (Total Pb =  $169 \cdot \text{SS} + 883$ ;  $r = 0.911$ ). The May 2001 Elizabeth River sample was collected during a wet weather event and had the highest Total Pb concentration of any sample collected (38,800 ng/L), with only a slightly elevated SS level (33 mg/L). However, since this was the only wet weather sample for the Elizabeth River, it cannot be concluded that it was an “outlier”. No single sampling event consistently had the highest Total Pb or dissolved Pb at all/most of the stations.

The coefficient of variation of the Total Pb concentrations ranged between 0.208 and 0.906 (except for ELIZ1 = 1.707), with all but four values less than 0.56 (Stations PAS2, PAS3, RHWY1, and ELIZ1). The coefficients of variation for the dissolved Pb data (range = 0.036 to 1.556) were larger, with eight values greater than 0.60.

Dissolved Pb ranged between 3.5 and 23.2% of the Total Pb (except for three samples: Station PA-S, May 2001 = 89.4%, Station RAR1-S, October 2001 = 223.7%, and Station HAC2, October 2001 = 44.8%), with a mean and standard deviation of  $17.4 \pm 29.4\%$ . Of the 62 blank corrected Total/Dissolved Pb samples, 9 had a % dissolved Pb > 21%, with 2 samples  $\geq 89\%$ ; omitting these two data points gives a mean and standard deviation of  $12.8 \pm 7.9\%$  dissolved Pb. Figure 32(a-e) shows examples of the partitioning of the Total Pb into dissolved and suspended sediment fractions – Pb is found primarily in the suspended sediment phase.

**Table 17: Total Pb Concentration (ng/L)**

	6/20- 22/00	12/13- 15/00	3/13- 15/01	4/12/01	4/25/01	5/15/01	5/24/01	10/17- 19/01	10/3/01	11/6/01	3/12- 14/02	3/27/02	5/14/02	Mean	Std. Dev.
<b>PAS1</b>	4060	6930	3030					7190						5303	2075
<b>PAS2/ PAS2a</b>		*	3310					15100						9205	8337
<b>PAS3</b>		5260	1750					11300						6103	4831
<b>NB1-S</b>	2690	2470	1340					1970						2118	600
<b>NB1-D</b>	5030	3770	1880					1800						3120	1565
<b>NB3</b>		2010	1450					2350						1937	454
<b>AK1-S</b>		5190	2410		2110		5120			1270			2380	3080	1659
<b>AK1-D</b>					1860		3250			1300			2140	2138	820
<b>PA-S</b>		1507	1420				3020			1290				1809	812
<b>PA-D</b>					3410		3280			1210				2633	1234
<b>HAC1</b>	3240	5340	2470					4350			1680			3416	1459
<b>HAC2</b>		5680	4670					5630			2020			4500	1717
<b>HAC3</b>		6860	9660					6190			9150			7965	1698
<b>KVK1</b>		3070	1090					1750			977			1722	961
<b>RAR1-S</b>				2840		2140			1350			1580		1978	664
<b>RAR1-D</b>				2180		2390			1890			1440		1975	411
<b>RAR2</b>				1900		3150			2560			1520		2283	720
<b>RWY1</b>					2450		11400			3410			10300	6890	4611
<b>ELIZ1</b>					1520		38800			1230			2040	10898	18605

\* The December 2000 sample was collected at Station PAS2 while construction activities were underway just upstream; all other samples were collected at Station PAS2a. Omitted because of a very high value due to this construction.

**Table 18: Dissolved Pb Concentration (ng/L)**

	6/20- 22/00	12/13- 15/00	3/13- 15/01	4/12/01	4/25/01	5/15/01	5/24/01	10/17- 19/01	10/3/01	11/6/01	3/12- 14/02	3/27/02	5/14/02	Mean	Std. Dev.
<b>PAS1</b>	241	295	395					232						291	75
<b>PAS2/ PAS2a</b>		*830	520					1440						930	468
<b>PAS3</b>		806	320					1010						712	354
<b>NB1-S</b>	312	214	183					151						215	70
<b>NB1-D</b>	413	196	194					238						260	104
<b>NB3</b>		293	225					399						306	88
<b>AK1-S</b>		300	227		188		293			277			355	273	59
<b>AK1-D</b>					169		295			239			281	246	57
<b>PA-S</b>							2700			107				1404	1834
<b>PA-D</b>					150		748			99				332	361
<b>HAC1</b>	752	311	211					246			138			332	243
<b>HAC2</b>		623	594					2520			453			1048	984
<b>HAC3</b>		916	640					429			894			720	231
<b>KVK1</b>		192	206					176			134			177	31
<b>RAR1-S</b>				106					3020			113		1080	1680
<b>RAR1-D</b>				151					400**			338		296	130
<b>RAR2</b>				362					358			338		353	13
<b>RWY1</b>					184		1240			190			357	493	505
<b>ELIZ1</b>					183		1960			194			231	642	879

\* The December 2000 sample was collected at Station PAS2 while construction activities were underway just upstream; all other samples were collected at Station PAS2a.

\*\* 1/2 detection limit (value reported as "<800").

**Table 19: Suspended Sediment Pb Concentration (ug/g sed)**

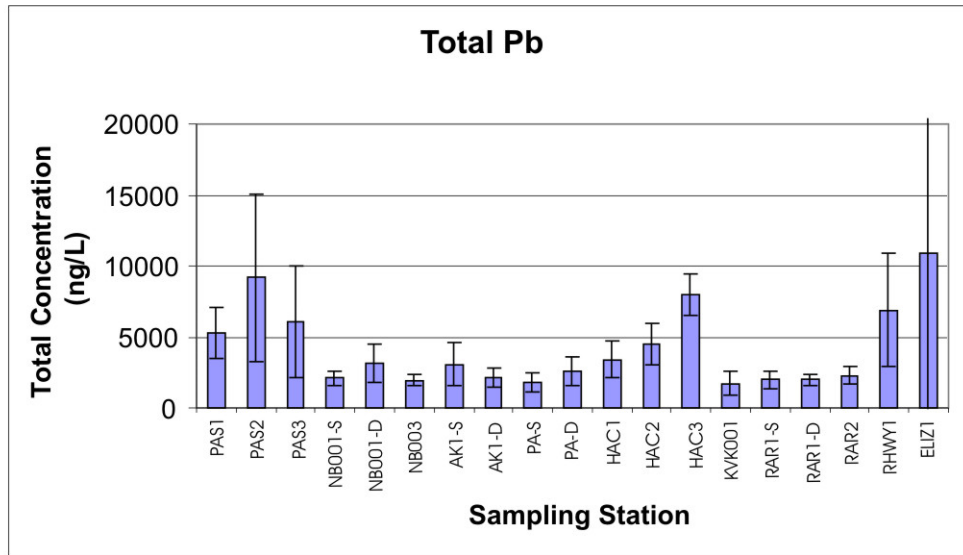
	6/20-22/00	12/13-15/00	3/13-15/01	4/12/01	4/25/01	5/15/01	5/24/01	10/17-19/01	10/3/01	11/6/01	3/12-14/02	3/27/02	5/14/02	Mean	Std. Dev.
PAS1	144	234	231					190						200	42
PAS2a		*	282					136						209	103
PAS3		730	280					179						397	293
NB1-S	159	322	154					271						227	84
NB1-D	191	255	112					193						188	59
NB3		337	138					102						192	126
AK1-S		429	202										422	351	129
AK1-D					249		290			247				262	24
PA-S		243	120				26			208				149	97
PA-D					206		253			242				234	25
HAC1	111	216	215					406			190			228	109
HAC2		184	168					129			151			158	24
HAC3		171	279					179			238			217	51
KVK1		221	96					162			211			173	57
RAR1-S				322		315						222		286	55
RAR2				108		202			138			107		139	45
RWY1					199		280			575			186	310	182
ELIZ1					157		1116			185			266	431	459

\* The December 2000 sample was collected at Station PAS2 while construction activities were underway just upstream; all other samples were collected at Station PAS2a. Omitted because of a very high value due to this construction.

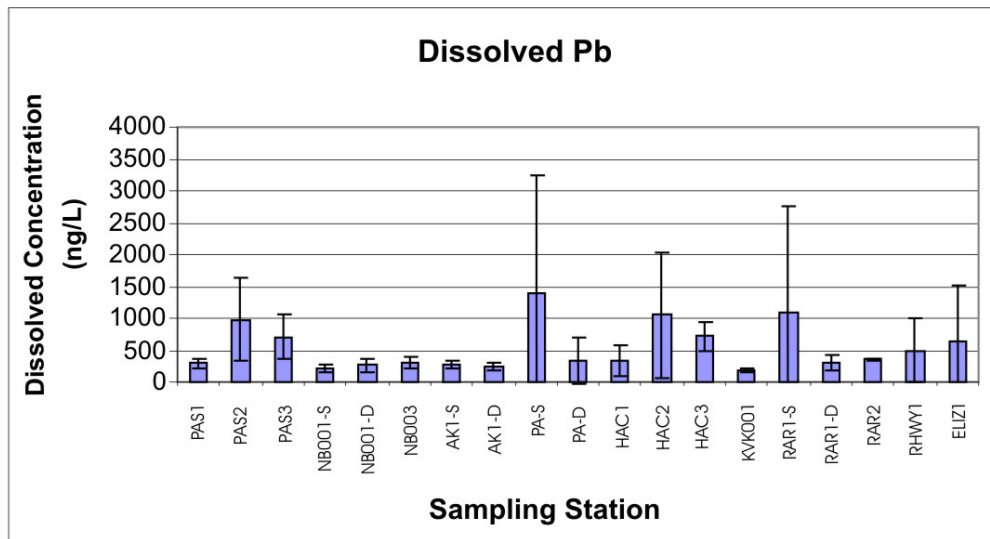
Note: SS was not collected in association with the Station RAR1-D samples, so the suspended sediment-normalized data is not available.

Mean Suspended Sediment Pb concentrations (Figure 33) were highest in the Elizabeth River (431 ug/g sed; but see the above discussion concerning the May 2001 Elizabeth River sample) and at the upper Passaic River Station PAS3 (397 ug/g sed). Mean concentrations ranged between 139 and 351 ug/g sed at the other stations. Over all sampling stations, there was no correlation ( $r = -0.11$ ) between Suspended Sediment Pb(ug/g sed) and SS (mg/L). There was a moderate correlation between Suspended Sediment Pb and Total Pb (Suspended Sediment Pb [ng/g sed] =  $17.1 * \text{Total Pb [ng/L]} + 184,318$ ;  $r = 0.59$ ).

The coefficient of variation of the Total Pb concentrations ranged between 0.092 and 0.739 (except for ELIZ1 = 1.065), with all but four values less than 0.60 (Stations PAS3, NB3, PA-S, and ELIZ1).

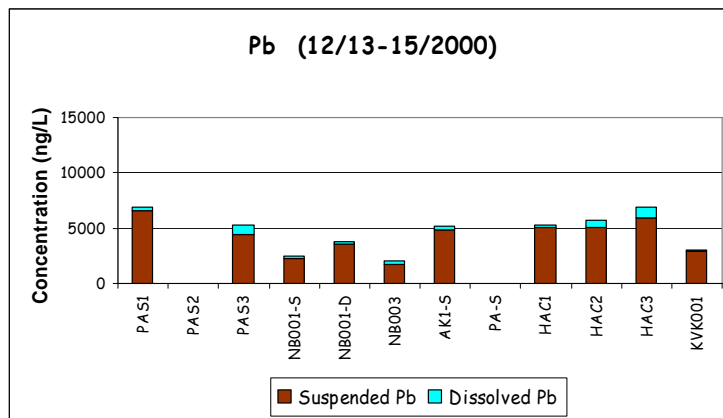


**Figure 30:** Mean  $\pm$  standard deviation of the Total Pb concentration at each sampling station.

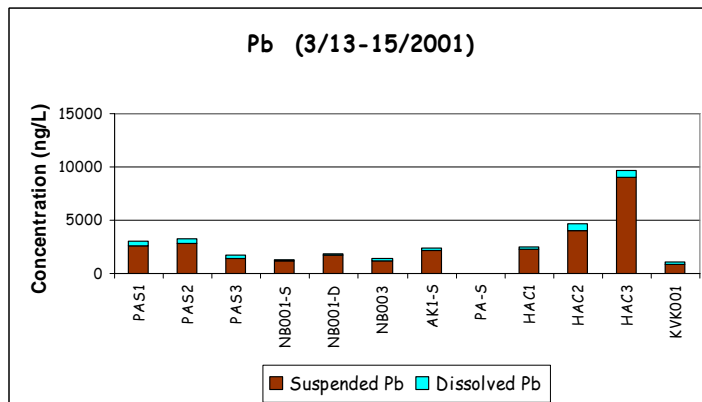


**Figure 31:** Mean  $\pm$  standard deviation of dissolved Pb concentration at each sampling station.

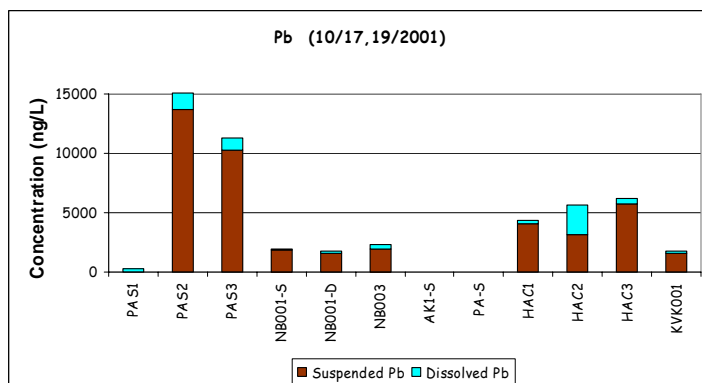
(a)



(b)



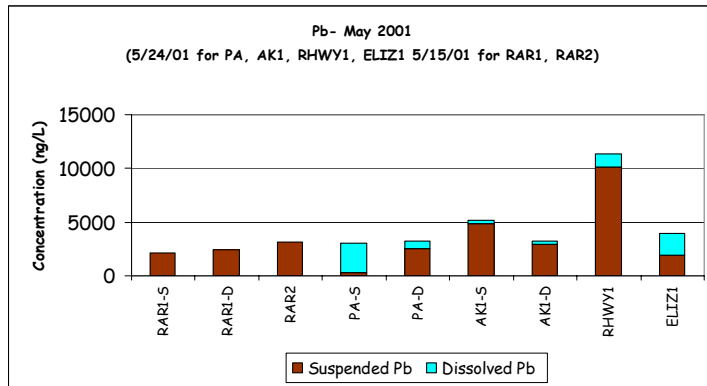
(c)



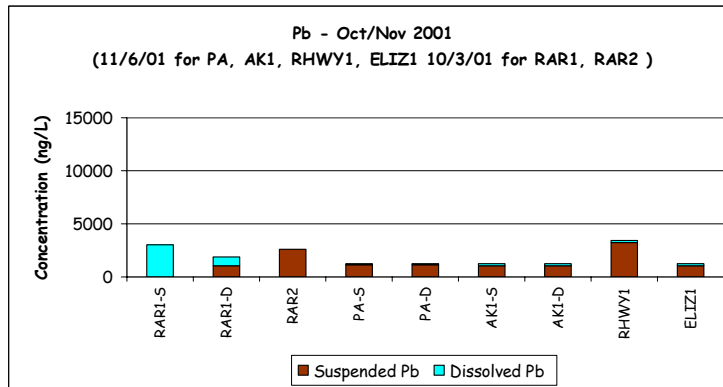
**Figure 32(a-e):** Pb partitioning between the dissolved and suspended phases in the (a) Dec 2000, (b) March 2001, (c) October 2001 – Northern Tributaries, (d) May 2001, and (e) Oct/Nov 2001 – Southern Tributaries sampling events



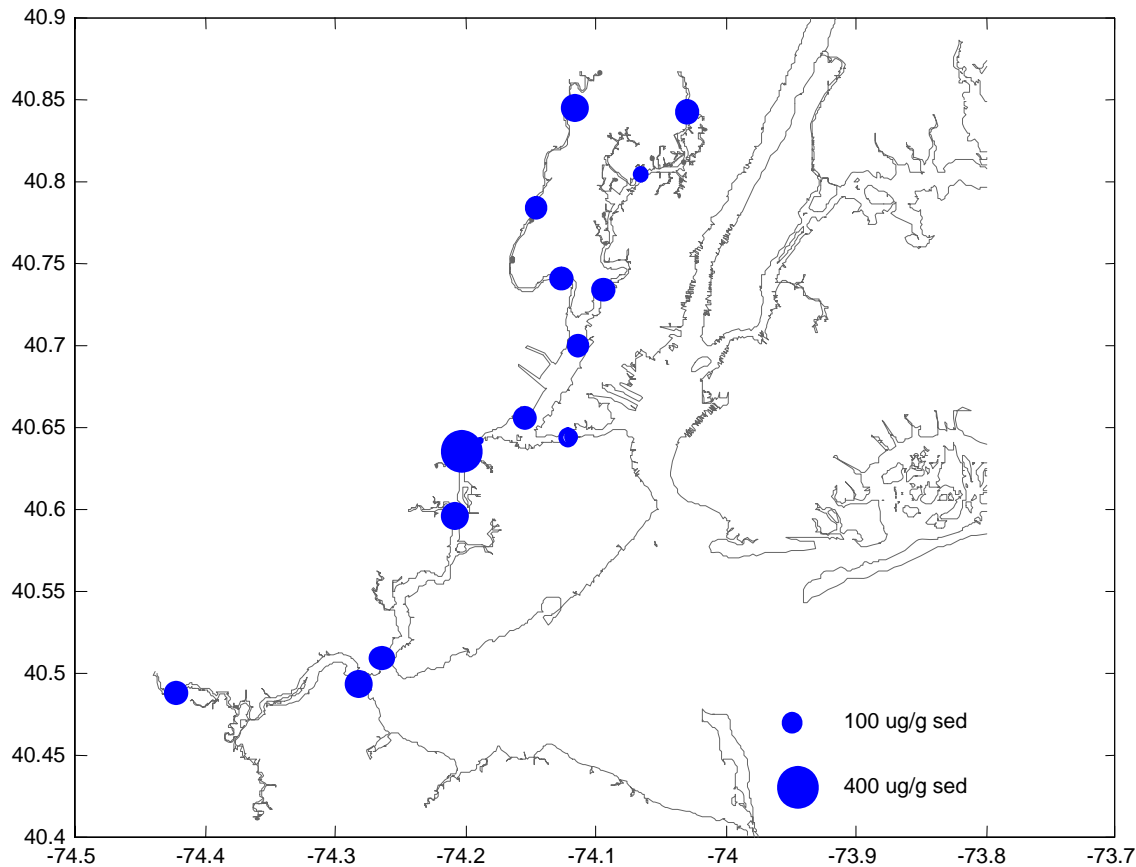
(d)



(e)



**Figure 32(a-e):** Pb partitioning between the dissolved and suspended phases in the (a) Dec 2000, (b) March 2001, (c) October 2001 – Northern Tributaries, (d) May 2001, and (e) Oct/Nov 2001 – Southern Tributaries sampling events



**Figure 33:** Mean Suspended Sediment Pb concentration at each station (ug/g sed).

### 5.3.4.2 Wet vs. Dry Events

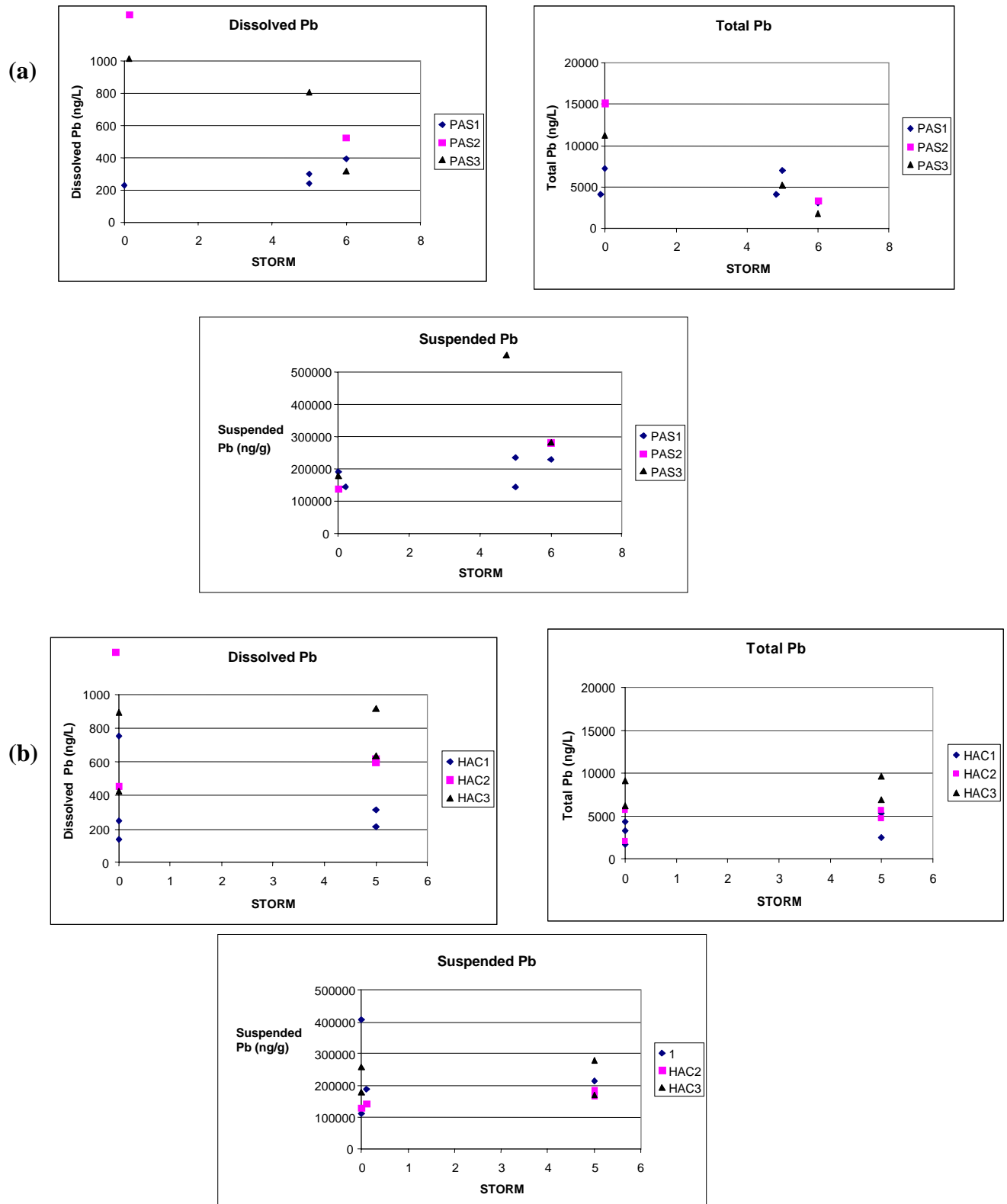
Figure 34(a-e) shows Dissolved Pb (ng/L), Total Pb (ng/L) and Suspended Sediment Pb (ng/g sed) concentrations at all sampling stations as a function of river flow conditions (i.e. storm magnitude, see Appendix A and Table 3). Given the limited number of data points and the variability in the data, it is difficult to make any firm conclusions on wet vs. dry event trends. However, note the following general observations:

- Dissolved Pb concentration did not appear to vary with river flow at any of the sampling stations, although levels were elevated at stations PAS2/3 (> 1,000 ng/L) during dry weather;
- Total Pb tended to decrease, and suspended sediment Pb (ng/g sed) increase, in the Passaic River (see Figure 34a) during wet weather;

- The Rahway River tends to show higher Total Pb (and perhaps suspended sediment Pb) concentrations during wet events (see Figure 34d). The Rahway River Head-of-Tide station also has elevated Total and dissolved Pb concentrations during wet weather (see Wilson and Bonin, 2007). This may be an indication of an upstream source of Pb in this river.
- Total Pb and suspended sediment Pb tended to decrease at Station RAR2 during wet weather (see Figure 34e);

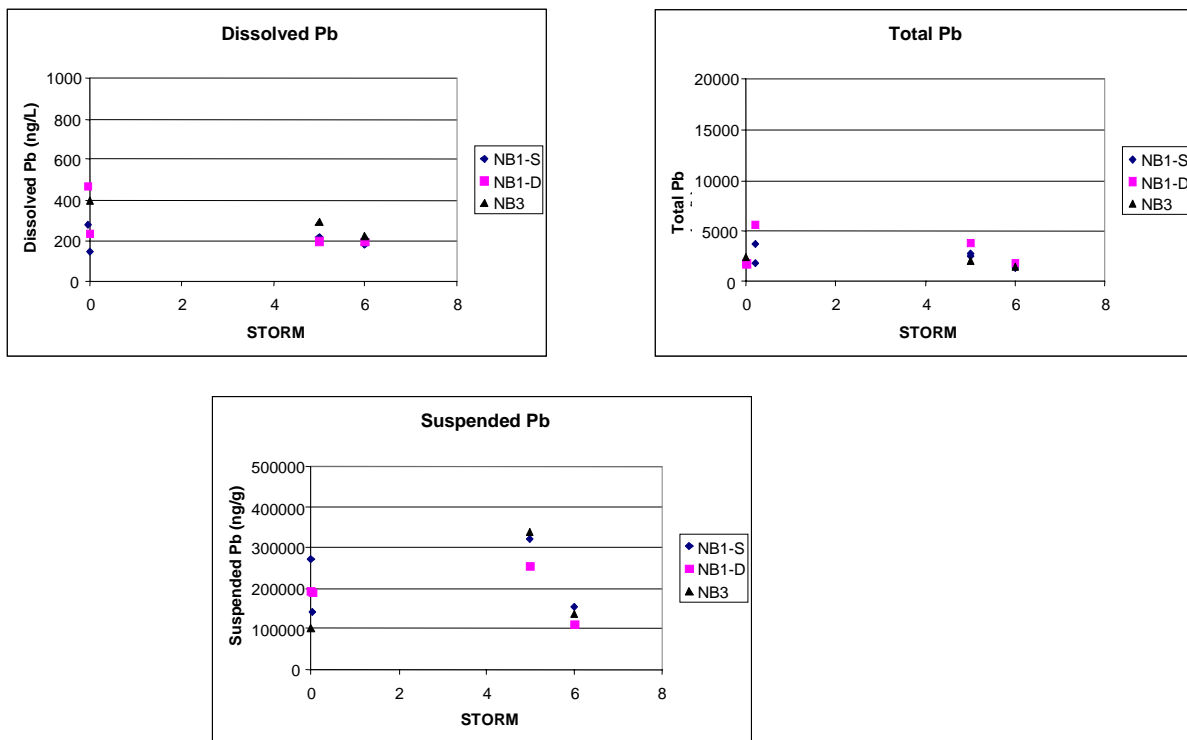
#### **5.3.4.3 Surface vs. Bottom Samples**

At Stations NB1, PA, RAR1, and AK1, both surface (5 feet below the surface) and bottom (5 feet above the bottom) samples were taken. As shown in Figure 35, no significant trends in the data were observed. However, at Station NB1, suspended sediment Pb tended to be higher at the surface, and dissolved and Total Pb higher at depth.

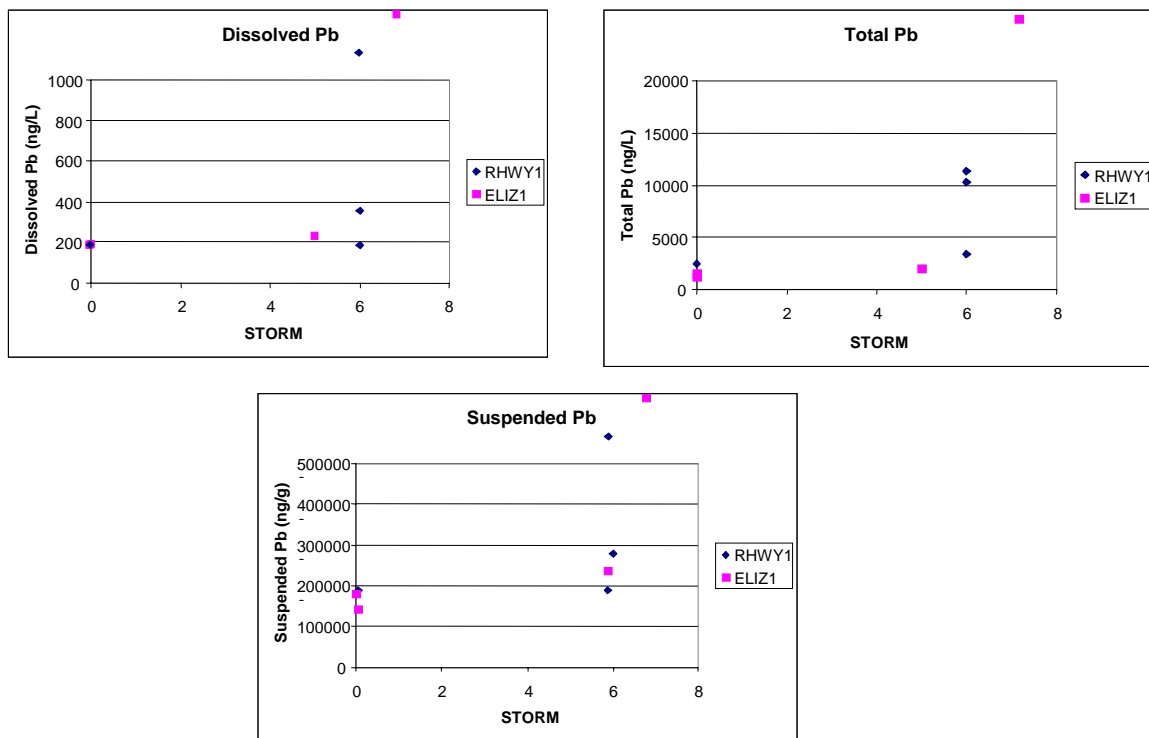


**Figure 34(a-e):** Dissolved Pb (ng/L), Total Pb, and Suspended Sediment Pb (ng/g sed) Concentrations – Wet and Dry Events. (a) Passaic River, (b) Hackensack River, (c) Newark Bay, (d) Rahway and Elizabeth Rivers, (e) Raritan River

(c)

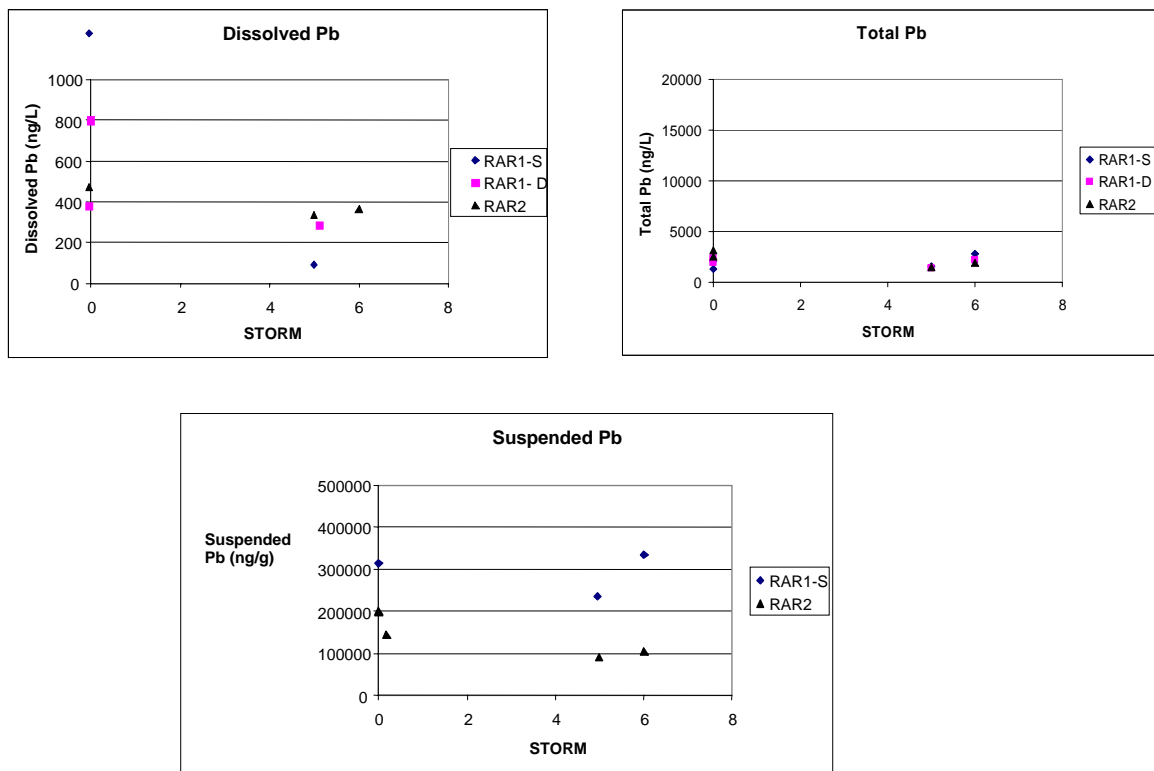


(d)

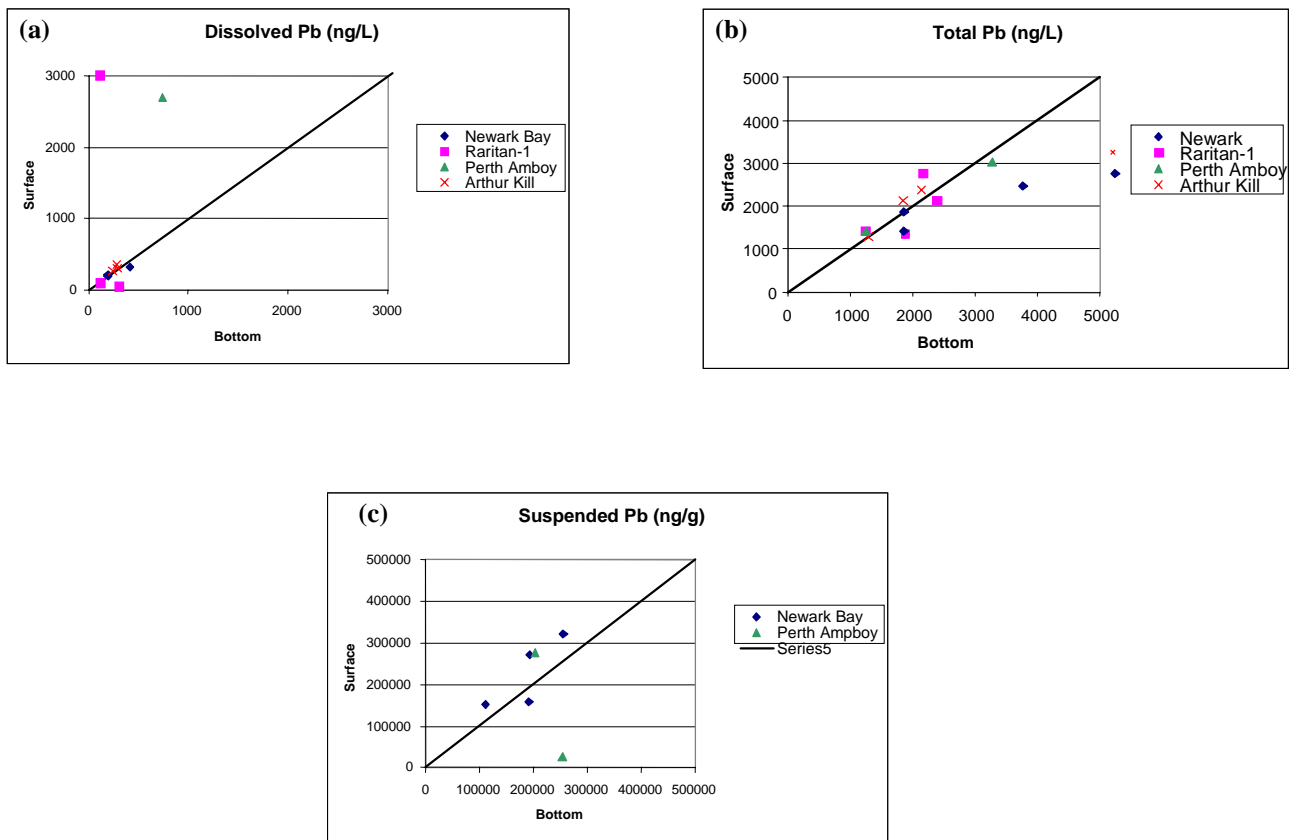


**Figure 34(a-e):** Dissolved Pb (ng/L), Total Pb, and Suspended Sediment Pb (ng/g sed) Concentrations – Wet and Dry Events. (a) Passaic River, (b) Hackensack River, (c) Newark Bay, (d) Rahway and Elizabeth Rivers, (e) Raritan River

(e)



**Figure 34(a-e):** Dissolved Pb (ng/L), Total Pb, and Suspended Sediment Pb (ng/g sed) Concentrations – Wet and Dry Events. (a) Passaic River, (b) Hackensack River, (c) Newark Bay, (d) Rahway and Elizabeth Rivers, (e) Raritan River



**Figure 35:** Surface vs. Bottom Samples (a) Dissolved Pb, (b) Total Pb, and (c) Suspended Sediment Pb concentrations.

### 5.3.5 Mercury (Hg)

#### 5.3.5.1 Measurements

Table 20, Table 21, and Table 22 present the Total Hg (ng/L), dissolved Hg (ng/L), and Suspended Sediment Hg (ng/g) concentrations, respectively, as well as the overall arithmetic mean and standard deviation of this data, in the ambient water grab samples at all sampling stations during all sampling events.

Mean Total Hg concentrations were highest in the middle (79.7 ng/L) and upper (190.8 ng/L) Hackensack River, the Rahway River (87.3 ng/L), and the middle (61.9 ng/L) and lower (55.8 ng/L) Passaic River (also see Figure 36 and 38). Mean Total Hg concentrations were less than 48 ng/L at the other stations, with the lowest values in the Raritan River and at the surface estuarine stations (9.5 – 18.5 ng/L; except for Station AK1-S).

Over all sampling stations and sampling events, there was a moderate correlation between Total Hg and SS (Total Hg [ng/L] = 2.13\*SS [mg/L] + 9.7; r = 0.60). Omitting one data point – the Hackensack River Station HAC3 March 2002 sample – slightly improves the Total Hg:SS correlation (Total Hg = 1.78\*SS + 10.8; r = 0.75). No single sampling event consistently had the highest Total Hg or dissolved Hg at all/most of the stations.

The coefficient of variation of the Total Hg concentrations ranged between 0.245 and 1.050, and within a given water body, was consistently low only at the Raritan River stations (0.245 – 0.285).

At those stations where both surface (S) and deep (D) samples were collected, there was little apparent difference in the mean total Hg levels. However, there was a tendency for Total Hg concentrations to be higher at Stations NB1-D (compared to NB1-S) and at Station RAR1-D (compared to RAR1-S). At those stations where both surface (S) and deep (D) samples were collected, there was also little apparent difference in the mean dissolved Hg levels.

Mean dissolved Hg concentrations (see Table 21) were highest in the Elizabeth River (5.71 ng/L), with elevated levels in the middle (2.25 ng/L) and upper (1.55 ng/L) Hackensack River, the Rahway River (1.52 ng/L), and the upper Raritan River (1.92 ng/L). Mean dissolved Hg concentrations were less than 1 ng/L at the other stations. The coefficient of variation of the dissolved Hg concentrations ranged between 0.093 and 1.429.



**Table 20: Total Hg Concentrations (ng/L)**

	6/20- 22/00	12/13- 15/00	3/13- 15/01	4/12/01	4/25/01	5/15/01	5/24/01	10/17- 19/01	10/3/01	11/6/01	3/12- 14/02	3/27/02	5/14/ 02	Mean	Std. Dev.
<b>PAS1</b>	43.0	68.6	23.1					88.6						55.8	28.7
<b>PAS2/ PAS2a</b>		*	18.7					105.0						61.9	61.0
<b>PAS3</b>		22.6	7.6					83.9						38.0	40.4
<b>NB1-S</b>	6.4	23.6	10.8					21.8						15.7	8.4
<b>NB1-D</b>	74.2	38.4	18.6					17.7						37.2	26.4
<b>NB3</b>		19.2	11.9					19.6						16.9	4.3
<b>AK1-S</b>		77.5	17.2		27.2		120.0			14.3			28.7	47.5	42.3
<b>AK1-D</b>					23.4		45.3			17.9				28.9	14.5
<b>PA-S</b>		12.8	11.7				23.6			11.5				14.9	5.8
<b>PA-D</b>					38.1		30.4			11.6				26.7	13.6
<b>HAC1</b>	51.6	62.2	19.5					58.4			25.4			43.4	19.6
<b>HAC2</b>		93.3	75.8					114.0			35.5			79.7	33.3
<b>HAC3</b>		127.0	124.0					125.0			387.0			190.8	130.8
<b>KVK1</b>		28.8	18.4					13.7			11.4			18.1	7.7
<b>RAR1-S</b>				17.2		16.5			9.2			11.3		13.6	3.9
<b>RAR1-D</b>				19.7		22.3			19.6			11.9		18.4	4.5
<b>RAR2</b>				8.2		12.5			10.2			7.2		9.5	2.3
<b>RWY1</b>					33.6		115.0			37.7			163.0	87.3	62.8
<b>ELIZ1</b>					22.4		59.8			16.2				32.8	23.6

\* The December 2000 sample was collected at Station PAS2 while construction activities were underway just upstream; all other samples were collected at Station PAS2a. Omitted because of a very high value due to this construction.

**Table 21: Dissolved Hg Concentrations (ng/L)**

	6/20- 22/00	12/13- 15/00	3/13- 15/01	4/12/01	4/25/01	5/15/01	5/24/01	10/17- 19/01	10/3/01	11/6/01	3/12- 14/02	3/27/02	5/14/02	Mean	Std. Dev
<b>PAS1</b>	0.88	0.47	1.09											0.81	0.32
<b>PAS2/ PAS2a</b>		*1.72	1.19					0.24						1.05	0.75
<b>PAS3</b>		1.61	1.09					0.12						0.94	0.76
<b>NB1-S</b>	0.57	0.50												0.54	0.05
<b>NB1-D</b>	0.34	0.55												0.45	0.15
<b>NB3</b>		0.70						0.58						0.64	0.09
<b>AK1-S</b>		0.59			0.15		0.37			0.31			3.44	0.97	1.39
<b>AK1-D</b>					0.33		0.58						1.73	0.88	0.75
<b>PA-S</b>		0.47								0.14				0.31	0.23
<b>HAC1</b>	0.86	0.70						0.50			0.62			0.67	0.15
<b>HAC2</b>		1.21	1.43					0.94			5.42			2.25	2.12
<b>HAC3</b>		2.46	1.10					0.21			2.41			1.55	1.09
<b>KVK1</b>											6.37			NA	NA
<b>RAR1-S</b>				0.75		0.71			0.79				0.22	0.62	0.27
<b>RAR1-D</b>				0.40		0.75			0.40				0.25	0.45	0.21
<b>RAR2</b>				2.12		1.72			2.53				1.38	1.92	0.50
<b>RWY1</b>					0.30		4.60			0.11			1.08	1.52	2.09
<b>ELIZ1</b>					0.75		5.90						10.49	5.71	4.87

\* The December 2000 sample was collected at Station PAS2 while construction activities were underway just upstream; all other samples were collected at Station PAS2a. Note: all of the sample data at Station PA-D, and all but one of the samples at Station KVK, were blank-censored.

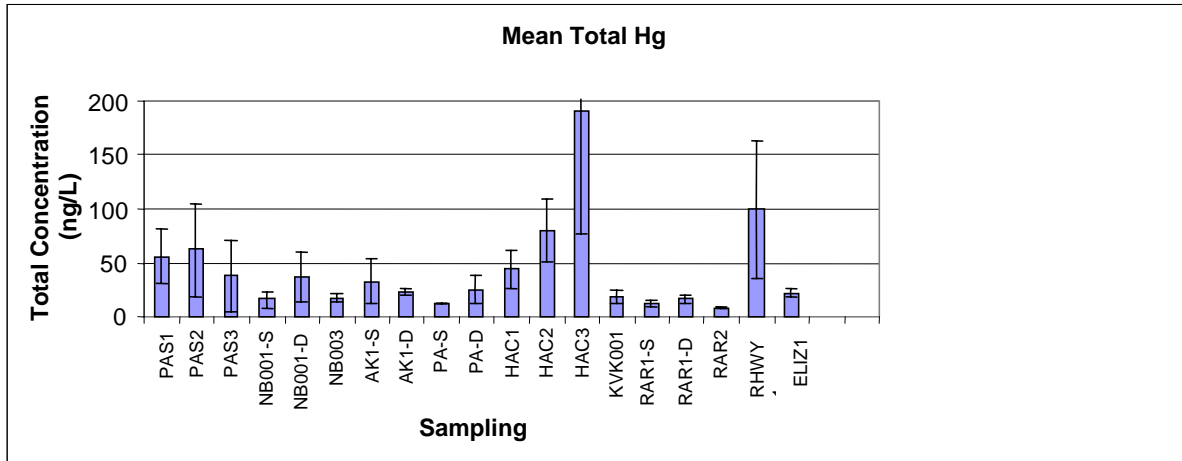
Dissolved Hg ranged between 0.14 and 64.8% of the Total Hg, with a mean and standard deviation of  $6.5 \pm 11.7\%$ , but with a median value of only 2.1%. Of the 59 blank corrected Total/Dissolved Hg samples, 9 had dissolved Hg > 10%, with all 4 samples at Station RAR2 and the 1 KVK sample  $\geq 10\%$  dissolved Hg. Four Hg samples were collected at Station KVK; but while all 4 samples had reportable blank-corrected Total Hg values, there was only one such dissolved Hg sample (March 2002), and this sample had a very high 55.9% dissolved Hg. This suggests that this sample may be an outlier. All four samples at Station RAR2 had consistently high % dissolved Hg (13.8 – 26.5 %), while the 8 samples at Station RAR1-S/D and the 4 samples at Station PA-S had lower % dissolved Hg (1.2 – 8.6 %). This suggests that there is a potential source of dissolved Hg located in the vicinity of Station RAR2. The May 2002 Elizabeth River sample had the highest % dissolved Hg (64.8%), but the other two samples collected at this station were much lower (3.4-9.9%). Omitting the data from Stations KVK, RAR2, and ELIZ, dissolved Hg ranged between 0.14 and 15.3% of the Total Hg, with a mean and standard deviation of  $3.3 \pm 3.5\%$ , and a median value of only 2.0%.

**Table 22: Suspended Sediment Hg Concentration (ng/g sed)**

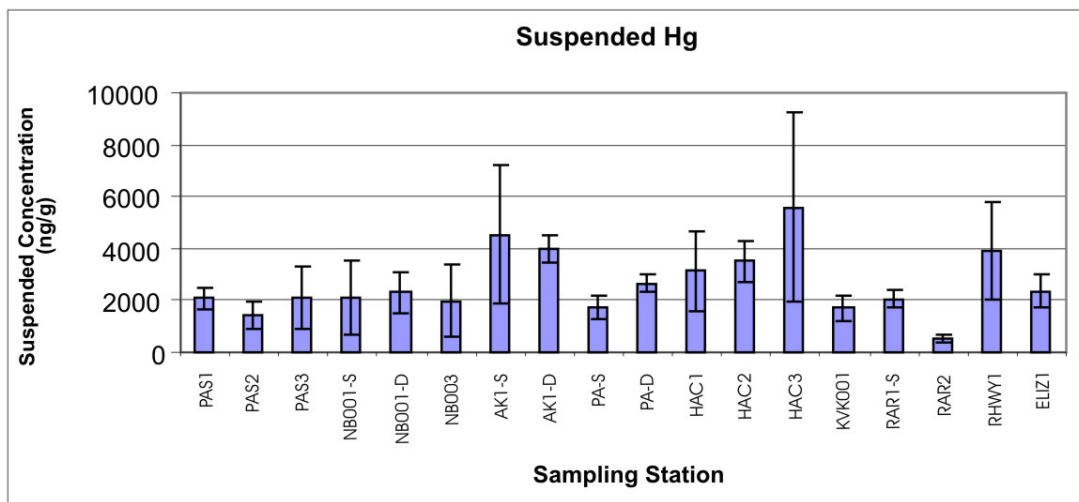
	6/20-22/00	12/13-15/00	3/13-15/01	4/12/01	4/25/01	5/15/01	5/24/01	10/17-19/01	10/3/01	11/6/01	3/12-14/02	3/27/02	5/14/02	Mean	Std. Dev.
<b>PAS1</b>	1589	2415	1921					2414						2085	403
<b>PAS2/ PAS2a</b>		*	1799					1048						1422	533
<b>PAS3</b>		3506	1355					1462						2107	1213
<b>NB1-S</b>	362	3357	1467					3254						2110	1453
<b>NB1-D</b>	3045	2675	1258					2185						2291	773
<b>NB3</b>		3588	1348					996						1977	1406
<b>AK1-S</b>		6790	1574									5263		4551	2682
<b>AK1-D</b>					3393		4384			4163				3980	520
<b>PA-S</b>		2021	1017				1888			1993				1730	479
<b>PA-D</b>					2411		3040			2522				2658	336
<b>HAC1</b>	2283	2631	1905					5733			3059			3122	1520
<b>HAC2</b>		3338	3081					4691			2892			3501	814
<b>HAC3</b>		3579	3805					3888			11083			5589	3665
<b>KVK1</b>		2215	2000					1412			1175			1701	488
<b>RAR1-S</b>				1912		2322			2338			1679		2063	303
<b>RAR2</b>				411		691			479			530		528	119
<b>RWY1</b>					2921		3041			6713			3021	3924	1860
<b>ELIZ1</b>					2547		1633			2893				2358	651

\* The December 2000 sample was collected at Station PAS2 while construction activities were underway just upstream; all other samples were collected at Station PAS2a. Omitted because of a very high value due to this construction.

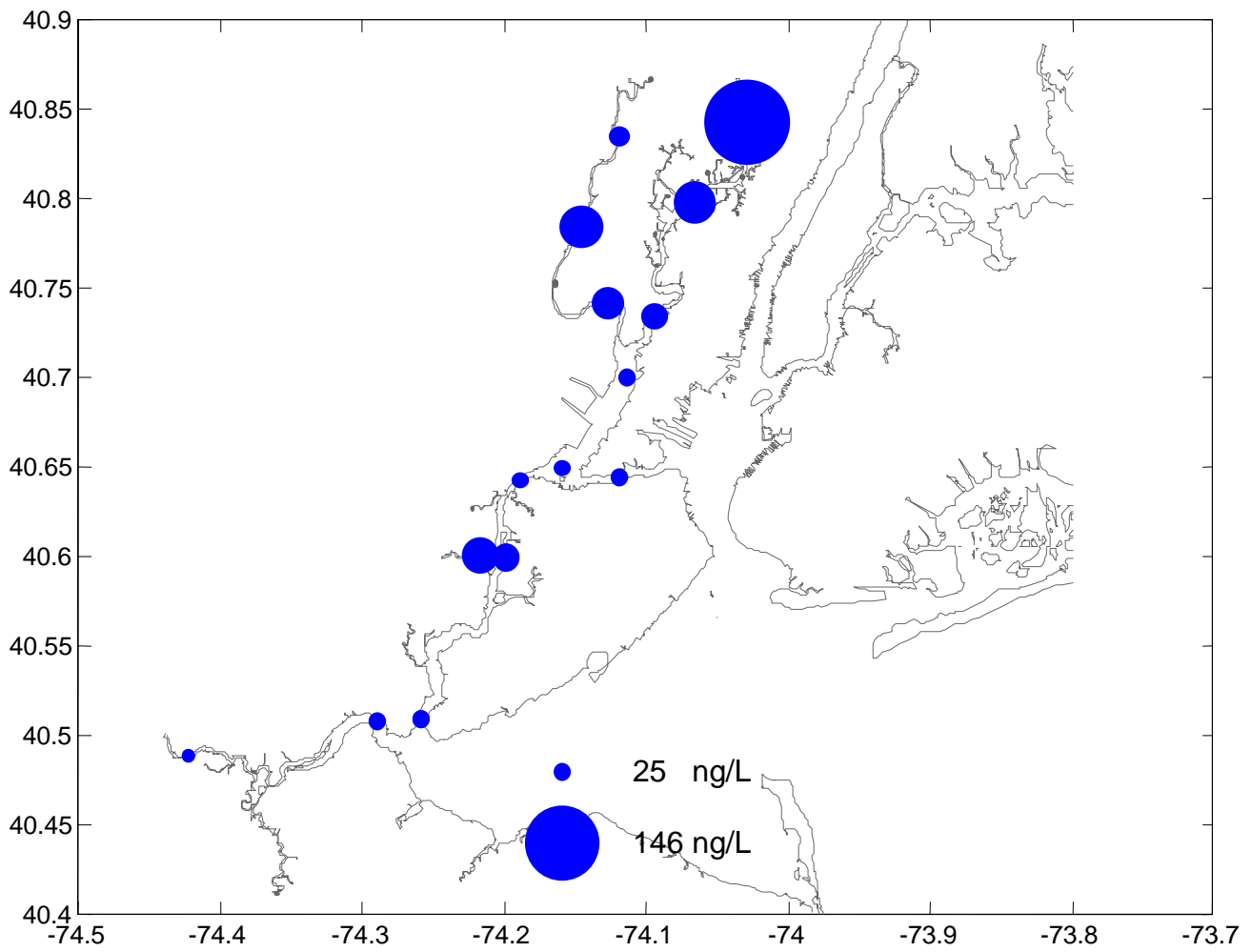
Table 22, Figure 37, and Figure 39 show the mean particulate Hg levels (ng/g sed) at each sampling station. The highest mean concentration (5,589 ng/g sed) was found at the upper Hackensack River (HAC3) station. Mean levels greater than 3,000 ng/g sed were observed at stations HAC2, HAC1, RHWY, RAR1-D and AK1-S/D. Over all sampling stations, there was no correlation ( $r = -0.02$ ) between Suspended Sediment Hg (ng/g sed) and SS (mg/L). There was a moderate correlation between Suspended Sediment Hg and Total Hg (Suspended Sediment Hg [ng/g sed] =  $19.6 \times \text{Total Hg [ng/L]} + 1837$ ;  $r = 0.639$ ).



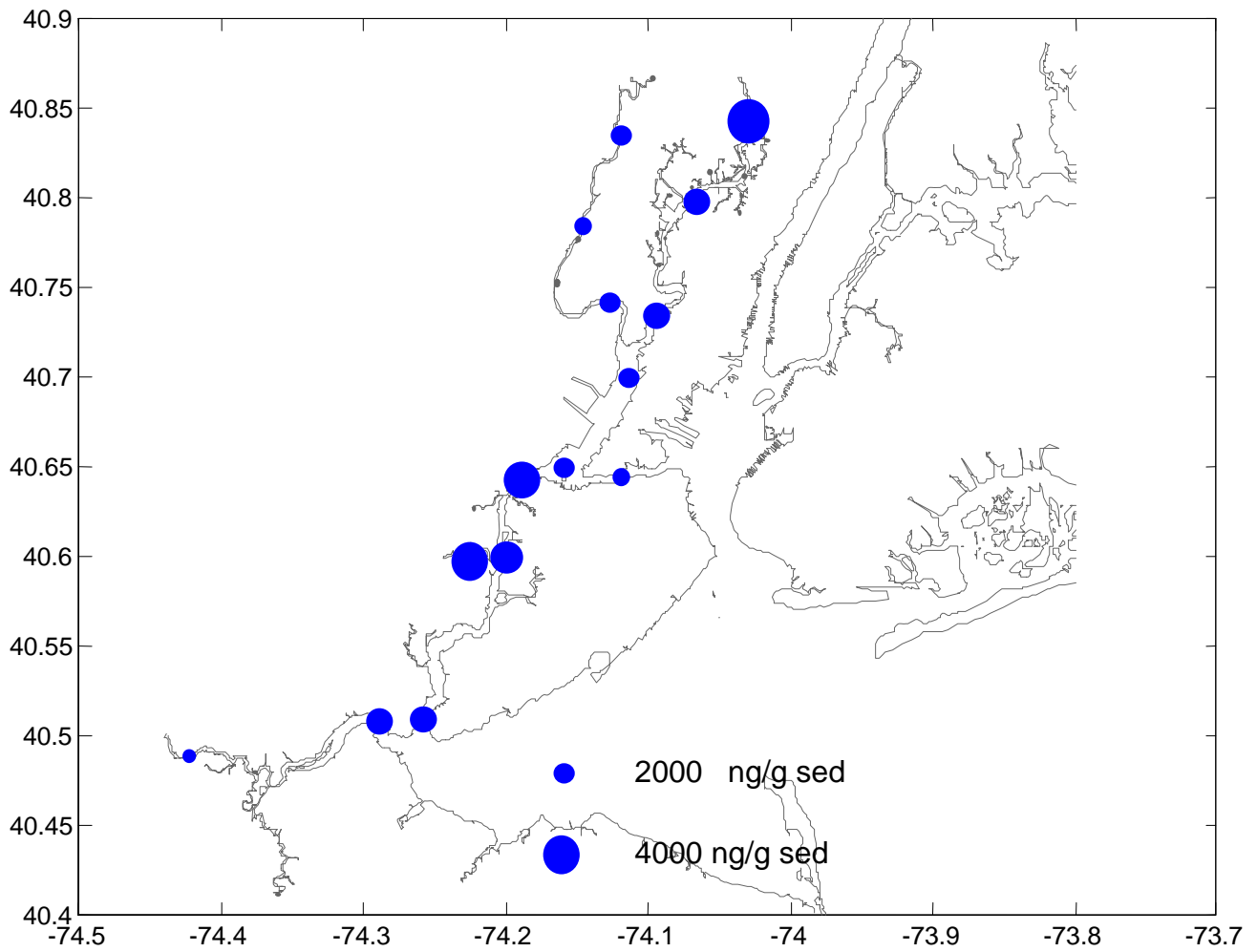
**Figure 36:** Mean  $\pm$  standard deviation of the Total Hg (ng/L) concentration at each sampling station.



**Figure 37:** Mean  $\pm$  standard deviation of Suspended Sediment Hg (ng/g sed) concentration at each sampling station.



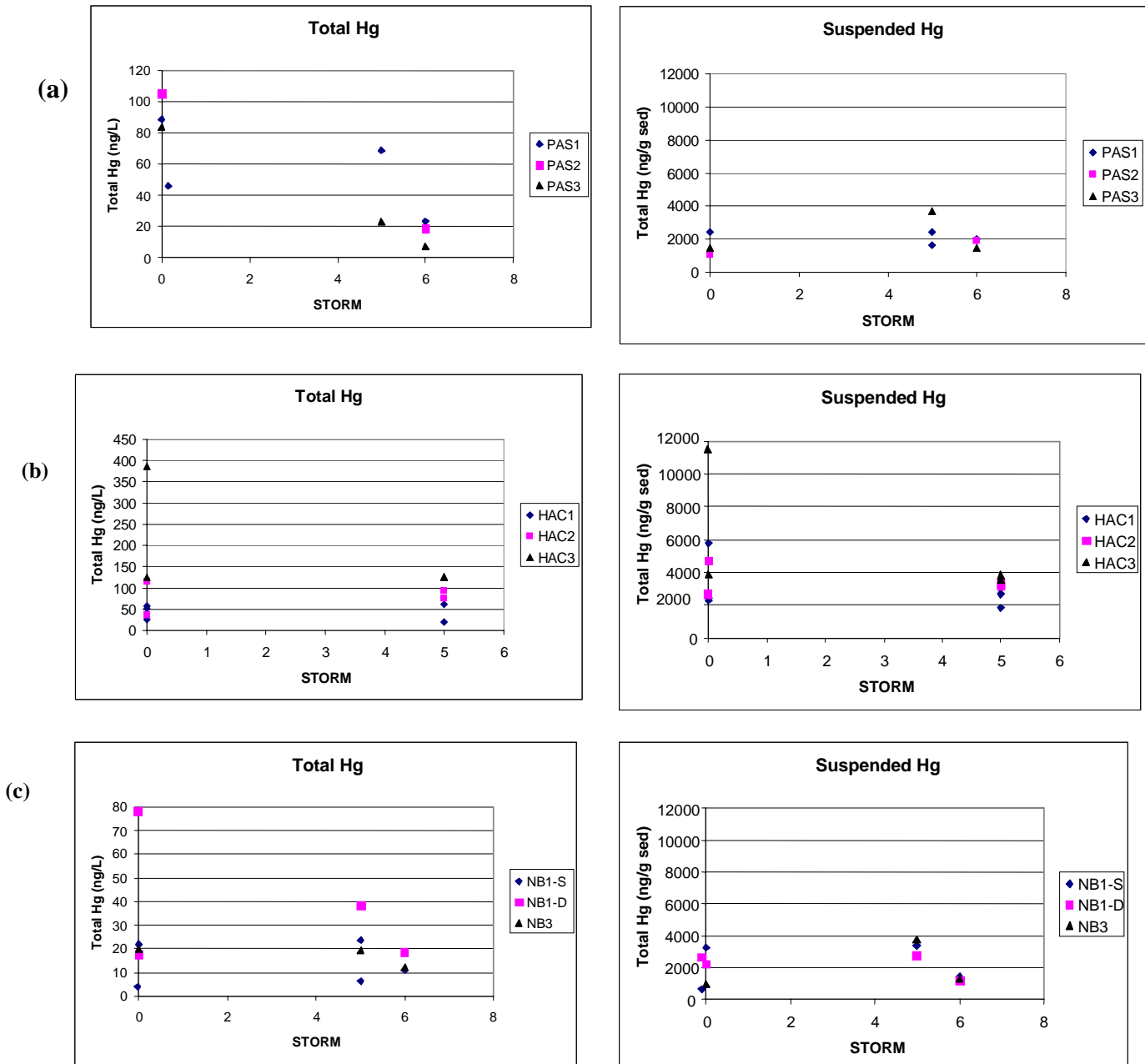
**Figure 38:** Mean Total Hg concentration at each sampling station (ng/L).

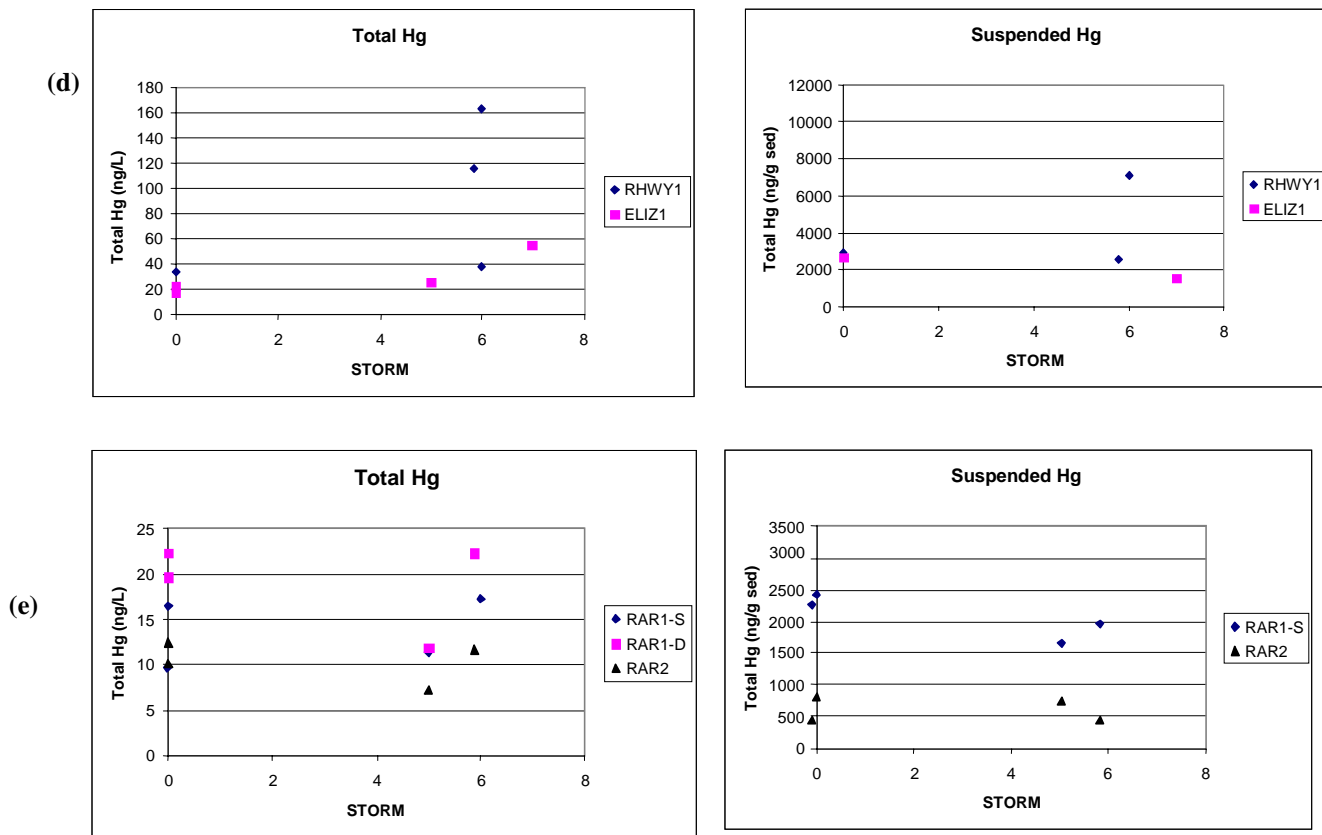


**Figure 39:** Mean Suspended Sediment Hg concentration at each station (ng/g sed).

### 5.3.5.2 Wet vs. Dry Events

Figure 40(a-e) shows a comparison between the mean dry weather and mean wet weather event Total Hg (ng/L) and Suspended Sediment Hg (ng/g sed) concentrations at all sampling stations. Although the data is limited, Total Hg in the Passaic River and Suspended Sediment Hg at Station RAR1-S, tended to decrease during wet weather. The Rahway River (RHWHY1) Station tends shows higher concentrations during wet events.





**Figure 40(a-e):** Total Hg and Suspended Sediment Hg Concentrations – Wet vs. Dry Events (a) Passaic River, (b) Hackensack River, (c) Newark Bay, (d) Rahway and Elizabeth Rivers, (e) Raritan River.

### 5.3.6 Methyl Mercury (methyl-Hg)

#### 5.3.6.1 Measurements

Table 23 and Table 24 give the Total methyl-Hg (ng/L) and dissolved methyl Hg (ng/L) concentrations in the ambient water grab samples at all sampling stations during all sampling events. Samples for Total methyl-Hg analysis were not collected until October 2001 (through May 2002). Thus, only a limited number of samples were collected and analyzed for total methyl-Hg; no such samples were collected at the ELIZ and PA-S/D stations. Therefore, this data must be used with caution.

The highest Total methyl-Hg concentrations were observed at the upper Hackensack River station (HAC3), but only two samples with very different concentrations (13.5 ng/L and 0.75 ng/L) were collected at that station. Except for Station PAS2 (0.772 ng/L), Total methyl-Hg was less than 0.5 ng/L at all of the remaining stations.



Dissolved methyl-Hg concentrations were also highest at Station HAC3 (0.060 – 0.231 ng/L), as well as in the Rahway River (0.053 – 0.128 ng/L). Dissolved methyl-Hg concentrations ranged between 0.002 (1/2 the detection limit) and 0.099 ng/L at the other sampling stations.

Methyl Hg concentrations generally followed the pattern of Total Hg concentrations, with higher concentrations measured in the Hackensack River (particularly Station HAC3) and the Rahway River (Station RHWY1).

**Table 23: Total Methyl Hg Concentrations (ng/L)**

	6/20-22/00	12/13-15/00	3/13-15/01	4/12/01	4/25/01	5/15/01	5/24/01	10/17-19/01	10/3/01	11/6/01	3/12-14/02	3/27/02	5/14/02
PAS1								0.299					
PAS2a								0.772					
PAS3								0.468					
NB001-S								0.063					
NB001-D								0.047					
NB003								0.044					
AK1-S										0.048#			0.067
AK1-D										0.043#			0.079
PA-S										0.029#			
PA-D										0.028#			
HAC1								0.153			0.067		
HAC2								0.441			0.314		
HAC3								0.747			13.5		
KVK001								0.045			0.03#		
RAR1-S												0.074	
RAR1-D												0.065	
RAR2												0.095	
RHWY1										0.137			0.452
ELIZ1										0.034#			0.063

Samples for Total methyl-Hg analysis were not collected until October 2001.

#Use of sample data questionable because of possible blank contamination

From the available data, dissolved methyl-Hg ranged between 1.2 and 125.3% of the Total methyl-Hg (values > 100% are due to analytical variance), with a mean and standard deviation of  $26.4 \pm 32.3\%$ , but with a median of 12.0%. Of the 17 blank corrected Total/Dissolved methyl-Hg samples, 7 had a % dissolved methyl-Hg > 20%, with 4 samples  $\geq 47\%$ .

**Table 24: Dissolved Methyl Hg Concentration (ng/L)**

	6/20-22/00	12/13-15/00	3/13-15/01	4/12/01	4/25/01	5/15/01	5/24/01	10/17-19/01	10/3/01	11/6/01	3/12-14/02	3/27/02	5/14/02
PAS1	0.035		0.026					*0.0035					
PAS2a			0.032#					0.02					
PAS3			0.033#					0.022					
NB001-S	*0.013							*0.0035					
NB001-D	*0.013							0.012					
NB003								*0.0035					
AK1-S					0.018		0.011#			*0.014#			0.032
AK1-D					0.029		0.033#			*0.014#			0.099
PA-S							0.018#			*0.014#			
PA-D							*0.002#			*0.014#			
HAC1	*0.013							0.016			0.022#		
HAC2			0.055					0.038			0.075		
HAC3			0.060					0.090			0.231		
KVK001								0.023			*0.006#		
RAR1-S				0.012			*0.002#						
RAR1-D				0.012			*0.002#						
RAR2				0.06			0.066						
RHWY1					0.053		0.128#			*0.014#			0.083
ELIZ1					0.023		0.059#			*0.014#			0.044

\* value shown is 1/2 the detection limit.

#Use of sample data questionable because of possible blank contamination

### 5.3.7 Metals - Conclusions

- (1) Mean Total Cd (range = 39.7 to 168.7 ng/L) and dissolved Cd (range = 21.7 to 109.7 ng/L) at each of the sampling stations varied little throughout the harbor. This limited variability may be the result of the high % dissolved fraction of Cd in the water column (mean = 68.4%). There was only a slight correlation between Total Cd (ng/L) and Suspended Sediment (mg/L) in the harbor. Neither the New Jersey Saline Aquatic Chronic Water Quality Criteria (WQC) for dissolved Cd (8,800 ng/L) nor the Saline Human Health WQC for Total Cd (16,000 ng/L) were exceeded by any sample collected as part of this study.
- (2) Mean Total Pb (range = 1,722 to 10,898 ng/L) at each of the sampling stations varied by a factor of 5, and dissolved Pb (range = 177 – 1,566 ng/L) varied by a factor of 9. Most of the Pb was found in the suspended sediment fraction (mean = 82.6%), and there was a strong correlation between Total Pb (ng/L) and Suspended Sediment (mg/L) in the harbor. The highest Total Pb concentrations were measured in the Passaic, Hackensack, Rahway, and Elizabeth rivers, with lower concentrations at the estuarine and Raritan River stations. There was no correlation between Suspended Sediment Pb (ng/g sed) and SS (mg/L), but there was a moderate correlation between Suspended Sediment Pb and Total Pb (ng/L). The New

Jersey Saline Aquatic Chronic Water Quality Criteria (WQC) for dissolved Pb (24,000 ng/L) was not exceeded by any sample collected as part of this study.

- (3) Mean Total Hg (range = 9.5 to 190.8 ng/L) and dissolved Hg (range = 0.31 to 6.37 ng/L) at each of the sampling stations varied by a factor of 20 throughout the harbor. Most of the Hg was found in the suspended sediment fraction (mean = 93.5%), but there was only a moderate correlation between Total Hg and Suspended Sediment in the harbor. Mean Total Hg concentrations were highest in the Hackensack, Rahway, and Passaic Rivers, with the lowest values in the Raritan River and at the surface estuarine stations. The highest mean Suspended Sediment Hg concentrations were also found in the Hackensack and Rahway Rivers, and elevated mean levels were found at Stations RAR1-D and AK1-S/D. There was no correlation between Suspended Sediment Hg (ng/g sed) and SS (mg/L), but there was a moderate correlation between Suspended Sediment Hg and Total Hg (ng/L). The New Jersey Saline Aquatic Chronic Water Quality Criteria (WQC) for dissolved Hg (940 ng/L) was not exceeded by any sample collected as part of this study. The New Jersey Saline Human Health WQC for Total Hg (51 ng/L) was exceeded by the mean concentration in the lower/mid Passaic River (stations PAS1 and PAS2a), mid/upper Hackensack River (stations HAC2 and HAC3), and the Rahway River, and by individual samples at stations PAS3, HAC1, ELIZ1, NB1-D, and AK1-S.
- (4) Methyl Hg concentrations generally followed the pattern of Total Hg concentrations, with higher concentrations measured in the Hackensack River (particularly Station HAC3) and the Rahway River.
- (5) The applicable New Jersey Saline WQC for Cd and Pb were not exceeded by any of the samples collected in this study. This indicates that Cd and Pb do not have significant adverse impacts on overall water quality in the study area. In contrast, the New Jersey Saline Human Health WQC for Total Hg was exceeded throughout the study area, particularly in the Passaic, Hackensack, and Rivers. This indicates that Hg is having significant adverse impacts on overall water quality.

## 5.4 PCBs

### 5.4.1 Sample Analysis

A modified version of USEPA Method 1668A was used to analyze the TOPS samples for suspended sediment bound and dissolved concentrations of 114 PCB congeners. This method used high-resolution gas chromatography and mass spectrometry (HRGC/HRMS) with isotope dilution to analyze the TOPS filter and XAD resin samples. Of the 114 PCB congeners selected by the NJ Toxics Reduction Workplan for measurement (see Table 1), 73 congeners did not coelute with other congeners, 15 congeners coeluted with congeners on the target analyte list, and 26 coeluted with congeners not on the target analyte list.

The detection limit achieved for each PCB congener varied among the samples, due to analytical differences as well as differences in sample size. Considering all congeners, for the dissolved phase (XAD) samples, detection limits ranged between 0.47 and 21.82 pg/L, with a mean  $\pm$  standard deviation of  $5.98 \pm 5.10$  pg/L. For the suspended sediment phase (TOPS filters) samples, detection limits ranged between 0.28 and 12.66 pg/L, with a mean  $\pm$  standard deviation of  $2.36 \pm 2.44$  pg/L; and between 13.6 and 2079 pg/g sed, with a mean  $\pm$  standard deviation of  $194.15 \pm 268.60$  pg/g sed.

### 5.4.2 NJTRWP Blank Correction

The sample data was subjected to a preliminary Quality Assurance Verification Review. In addition, because of the nature of the samples and the trace concentrations expected for the target analytes, a “maximum blank” approach was developed to assess the impact of background contamination on the usability of the sample data. For each survey, one (1) Equipment Blank (XAD resin, dissolved fraction only) was prepared in the laboratory by pumping four (4) liters of water supplied by the analytical laboratory through a TOPS after it had been cleaned and prepared for sampling. One (1) TOPS Filter set and one (1) XAD resin column Field Blank were collected at each sampling location. The TOPS Filter Field Blank was collected by exposing a set of TOPS filters to the surrounding air while the TOPS filters that were used for sampling were installed and removed from the sampling equipment. Likewise, for the XAD Field Blank, a TOPS XAD resin column was exposed to the surrounding air (by opening the end caps on the column) while the TOPS XAD resin columns that were used for sampling were installed and removed from the sampling equipment. The Field Blanks from one of the sites in each survey were analyzed in the same manner as their associated samples; the remaining Field Blanks were archived. At least one (1) laboratory Method Blank was also prepared and analyzed by the analytical laboratory for each Sample Delivery Group (SDG). That blank having the largest value (the “maximum blank”) was used to assess the effect of background contamination on the sample data for that survey (see Section 4.3). In order for a sample result to be usable, it must have been at least three times (3X) greater than the “maximum blank”. The “3X maximum blank” factor was selected for use with PCBs because an analysis of the data indicated that use of

a 5X factor (see Section 4.3) was too conservative and would result in numerous “false negative” sample results. No other blank correction was performed on the sample data.

In the dissolved phase samples, congener PCB3 was removed from the useable data set in 96% of the samples. Other PCB congeners in the dissolved phase samples that were frequently removed by blank elimination included PCB8 (61%) and PCB194 (62%). In addition, the following congeners were removed from the useable data set for at least 20% of the samples: PCB11 (20%), PCB15 (31%), PCB105 (28%), PCB118 (22%), PCB138 (23%), PCB156 (34%), PCB157 (24%), PCB158 (20%), PCB167 (24%), PCB170 (34%), and PCB180 (28%).

The suspended sediment phase samples were rarely impacted by blank contamination (a total of 10 PCB congeners in 5 samples).

#### 5.4.3 Dissolved PCB Concentrations

Table 25 presents the Total Dissolved PCB concentrations (pg/L) at all sampling stations during all sampling events, as well as the overall arithmetic mean and standard deviation of this data. Over all sampling stations and surveys (n = 74 samples), the percentage of Total PCBs (dissolved + suspended sediment fractions) that is in the dissolved phase ranges from 4.0 to 82.2%, with a mean  $\pm$  standard deviation of  $33.3 \pm 16.4\%$ , and a median of 29.8%. The mean percentage of dissolved PCBs at the tributary stations ( $29.7 \pm 18.0\%$ ) did not differ from that at the estuary stations ( $34.9 \pm 13.8\%$ ).

As seen in Figure 41, there is little variation in the mean Total Dissolved PCB concentrations throughout the study area (range = 1,461 to 5,517 pg/L, overall mean =  $3,853 \pm 2,985$  pg/L). However, note that mean Total Dissolved PCBs tended to be lower at the Raritan River and Perth Amboy stations (range = 1,461 to 2,175 pg/L) compared with the other stations (range = 2,825 to 5,517 pg/L).

The coefficient of variation of the Total Dissolved PCB data ranged between 0.080 and 0.848. The coefficient of variation was higher at the mid/lower Passaic River and upper Newark Bay stations (range = 0.611 – 0.848) compared to the other stations (range = 0.080 – 0.415).

Mean Total Dissolved PCB concentrations were greater during dry weather conditions, compared to wet weather, at the Raritan River and mid/upper Passaic River (PAS2/3) stations. In contrast, mean concentrations were slightly greater during wet weather in Newark Bay and at Station PAS1. Mean Total Dissolved PCB concentrations did not appear to vary with weather conditions in the Hackensack, Rahway, and Elizabeth Rivers, and in the Kill van Kull.

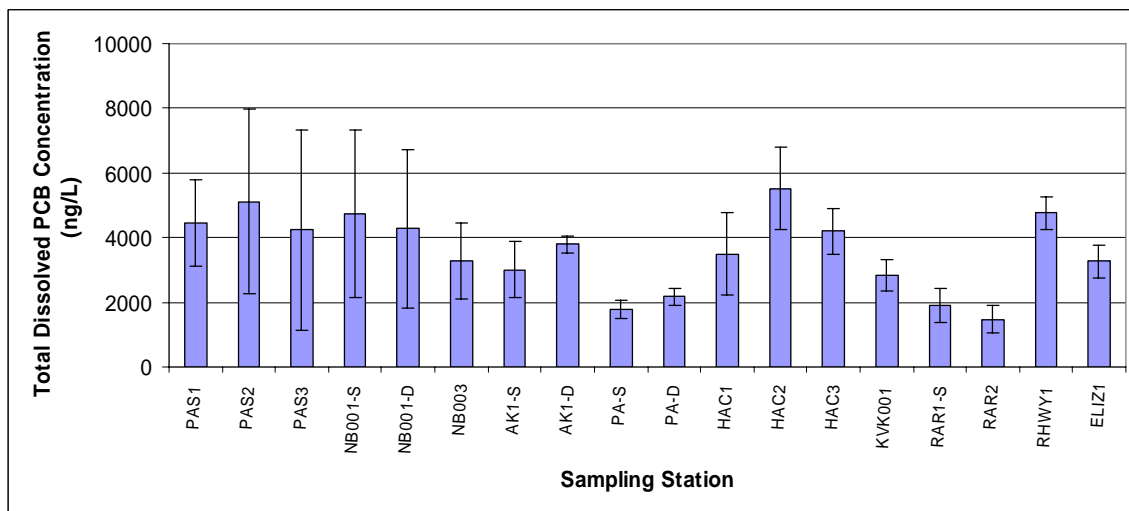
Synoptic surface (S) and deep (D) samples were collected only at Stations NB1-S/D, and during two sampling events at Stations PA-S/D. There was a tendency for the individual sample Total Dissolved PCB concentrations to be slightly greater at Station NB1-S, but the mean concentrations at Stations NB1-S/D did not differ (see Table 25). In contrast, sample concentrations were slightly greater at Station PA-D compared to PA-S. Mean concentrations

were also slightly greater at Stations PA-D and AK1-D, compared to Stations PA-S and AK1-S (see Table 25).

**Table 25:** Total Dissolved PCB Concentration (pg/L)

	6/20- 22/00	12/13- 15/00	3/13- 15/01	4/12/01	4/25/01	5/15/01	5/24/01	10/17- 19/01	10/3/01	11/6/01	3/12- 14/02	3/27/02	5/14/02	Mean	Std. Dev.
<b>PAS1</b>	7009	4045	3292					4414			3557			4464	1408
<b>PAS2a</b>		*3222	2130					9582			5536			5117	3298
<b>PAS3</b>		944	1387					6626			7974			4233	3589
<b>NB1-S</b>	9772	3252	2842					4505			3261			4727	2889
<b>NB1-D</b>	8649	2176	4725					4091			1769			4282	2741
<b>NB3</b>		5268	2552					2992			2287			3275	1360
<b>AK1-S</b>		2552	2266										4218	3012	1053
<b>AK1-D</b>					3463		3839			4063				3788	301
<b>PA-S</b>		1715	1547				1594			2277				1783	336
<b>PA-D</b>					1920		2082			2524				2178	310
<b>HAC1</b>	5958	2988	2863					3291			2347			3489	1422
<b>HAC2</b>		3588	6329					6973			5179			5517	1485
<b>HAC3</b>		3865	4997					3269			4778			4227	805
<b>KVK1</b>		2351	3224					3397			2327			2825	565
<b>RAR1-S</b>				2168		1866			2463			1070		1893	600
<b>RAR2</b>				1130		1491			2144			1080		1461	490
<b>RWY1</b>					4289		5615			4505			4677	4771	584
<b>ELIZ1</b>					2881		3624			3903			2653	3260	594

\* The December 2000 sample was collected at Station PAS2 while construction activities were underway just upstream; all other samples were collected at Station PAS2a



**Figure 41:** Mean  $\pm$  standard deviation Total Dissolved PCB concentrations (pg/L) at each sampling station.

#### 5.4.4 Suspended Sediment PCB Concentrations

Table 26 and Table 27 give the Total Suspended Sediment PCB concentrations in pg/L and ng/g sed, respectively, at all sampling stations during all sampling events, as well as the overall arithmetic mean and standard deviation of this data.

As seen in Table 26, the mean Total Suspended Sediment PCB concentrations (pg/L) were highest in the major tributaries: Passaic River (13,066 – 24,224 pg/L), mid/upper Hackensack River (11,362 – 19,188 pg/L), Rahway River (51,219 pg/L), and Elizabeth River (20,982 pg/L). Mean Total Suspended Sediment PCBs were lower (< 10,000 pg/L) at the Raritan River and estuarine sampling stations (range = 2,527 to 9,175 pg/L).

The highest mean Total Suspended Sediment PCB concentration (pg/L) was observed in the Rahway River (51,219 pg/L). In addition, there was a consistent difference in concentration at this station between dry weather surveys ( $13,187 \pm 3,200$  pg/L; n = 2) and wet weather surveys ( $89,251 \pm 32,138$  pg/L; n = 2). There were no such consistent wet/dry weather differences observed in the other rivers with elevated mean Total Suspended Sediment PCB concentrations.

Synoptic surface (S) and deep (D) samples were collected only at Stations NB1-S/D, and during two sampling events at Stations PA-S/D. Individual sample Total Suspended Sediment PCB (pg/L) concentrations at Stations NB1-S/D did not show a consistent trend, and the mean concentrations did not differ (see Table 26). Sample concentrations were slightly greater at Station PA-S compared to PA-D. Mean concentrations were also slightly greater at Stations PA-S and AK1-S, compared to Stations PA-D and AK1-D (see Table 26).

The coefficient of variation of the Total Suspended Sediment PCB data (pg/L) ranged between 0.176 and 1.026. Concentrations in the tributaries were more variable than concentrations at the estuarine locations. The coefficient of variation for the Total Suspended Sediment PCB data (pg/L) was greater than that for the Total Dissolved PCBs (pg/L) at every sampling station, except for those in Newark Bay and AK1-S.

Over all sampling stations and sampling events, there was moderate correlation between Total Suspended Sediment PCB (pg/L) and SS (Total SS-PCB [pg/L] = 516\*SS [mg/L] + 2,657; r = 0.74).

As seen in Figure 42, the mean Total Suspended Sediment PCB concentrations (ng/g sed) were highest in the Elizabeth (2,166 ng/g sed) and Rahway (1,500 ng/g sed) Rivers, and lowest in the Raritan River (310 – 476 ng/g sed). Mean concentrations were similar at the other sampling stations (range = 596 – 921 ng/g sed). There was a tendency for the mean Total Suspended Sediment PCB concentration (ng/g sed) in the tributaries to be greater during the dry weather, compared with the wet weather, surveys. An exception to this was the Rahway River, where there was no such wet/dry weather trend observed.

Synoptic surface (S) and deep (D) samples were collected only at Stations NB1-S/D, and during two sampling events at Stations PA-S/D. Individual sample Total Suspended Sediment PCB (ng/g sed) concentrations at Station NB1-S were typically greater than those at NB1-D, as was the mean concentration (see Table 27). There was no consistent trend in individual sample concentrations at Stations PA-S compared to PA-D. However, mean concentrations were slightly greater at Stations PA-S and AK1-S, compared to Stations PA-D and AK1-D (see Table 27).

The coefficient of variation of the Total Suspended Sediment PCB data (ng/g sed) ranged between 0.301 and 0.649. The coefficient of variation for the Total Suspended Sediment PCB data (pg/g sed) was less than that for Total Suspended Sediment PCB data (pg/L) at every station, except for Stations AK1-S/D, NB3, RAR1-S, HAC1, and HAC3.

Over all sampling stations, there was no correlation (r = -0.07) between Total Suspended Sediment PCBs (ng/g sed) and SS (mg/L). There was a slight correlation (r = 0.37) between Total Suspended Sediment PCBs (ng/g sed) and Total Suspended Sediment PCBs (pg/L).

Mean Total Suspended Sediment PCB concentrations (ng/g POC; data not shown) were highest at Stations PAS1 (44,476 ± 73,417 ng/g POC), PA-S (33,804 ± 43,863 ng/g POC), RWY1 (29,315 ± 13,109 ng/g POC), and ELIZ1 (22,166 ± 13,179 ng/g POC). The POC-normalized concentrations were elevated throughout the sampling area in the October 2001 survey; omitting this event from the calculation of mean concentrations lowers the mean at Station PAS1 to 11,655 ng/g POC. Likewise, the result for Station PA-S in the May 2001 survey was atypically elevated; omitting this sample from the calculation of mean concentrations lowers the mean at Station PA-S to 11,994 ng/g POC. Mean values at the remaining stations were less than 16,100 ng/g POC, with the lowest values in the Raritan River (4,027 to 7,785 ng/g POC), and at Stations HAC3 (6,494 ng/g POC) and PA-D (7,962 ng/g POC). These observations are similar to those made for the Total PCB ng/g sed concentrations.



**Table 26:** Total Suspended Sediment PCB Concentration (pg/L)

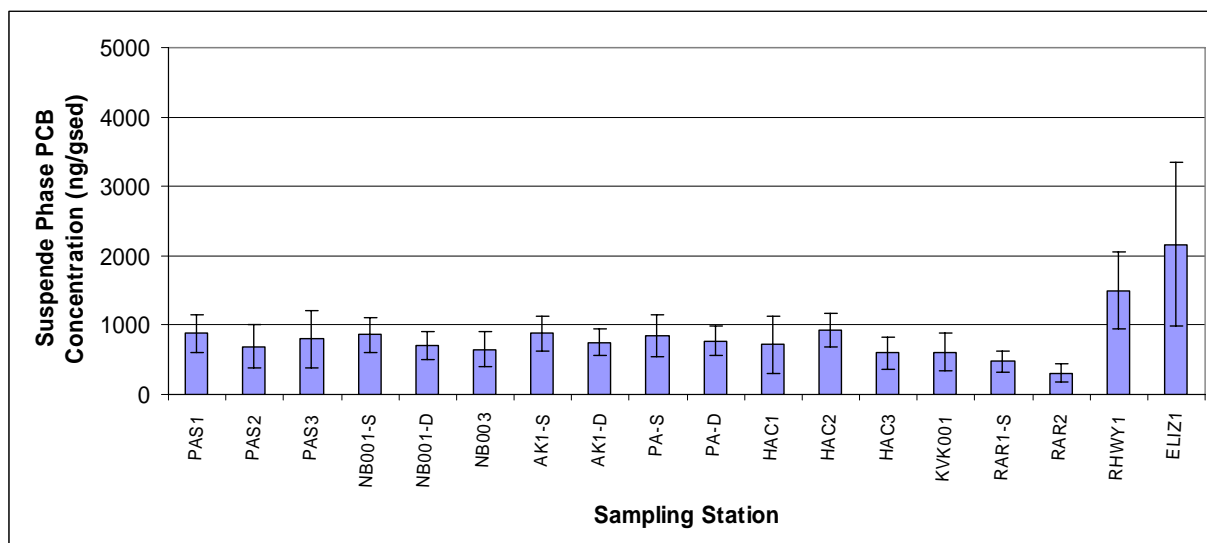
	6/20- 22/00	12/13- 15/00	3/13- 15/01	4/12/01	4/25/01	5/15/01	5/24/01	10/17- 19/01	10/3/01	11/6/01	3/12- 14/02	3/27/02	5/14/02	Mean	Std. Dev.
<b>PAS1</b>	39699	20173	7504					41033			12713			24224	15415
<b>PAS2a</b>		*12009	2955					31235						15400	14442
<b>PAS3</b>		3058	300					34362			14545			13066	15479
<b>NB1-S</b>	7466	11494	3620					12537			5415			8106	3837
<b>NB1-D</b>	10741	7699	4935					8712			5569			7531	2362
<b>NB3</b>		6343	3381					4311			3507			4386	1368
<b>AK1-S</b>		11636	6215										9676	9175	2725
<b>AK1-D</b>					6489		4171			5571				5410	1167
<b>PA-S</b>		4182	10263				12723			3338				7627	4589
<b>PA-D</b>					4373		7762			3032				5056	2438
<b>HAC1</b>	12649	1187	10174					14151			4346			8501	5538
<b>HAC2</b>		10694	7487					22141			5125			11362	7540
<b>HAC3</b>		22581	13524					27584			13062			19188	7109
<b>KVK1</b>		12303	5332					3823			5512			6743	3784
<b>RAR1-S</b>				5092		2751			1164			6319		3831	2314
<b>RAR2</b>				1042		3502			4244			1321		2527	1587
<b>RWY1</b>					15450		66525			10925			111976	51219	47710
<b>ELIZ1</b>					30068		42606			2783			8472	20982	18600

\* The December 2000 sample was collected at Station PAS2 while construction activities were underway just upstream; all other samples were collected at Station PAS2a

**Table 27: Total Suspended Sediment PCB Concentration (ng/g sed)**

	6/20-22/00	12/13-15/00	3/13-15/01	4/12/01	4/25/01	5/15/01	5/24/01	10/17-19/01	10/3/01	11/6/01	3/12-14/02	3/27/02	5/14/02	Mean	Std. Dev.
<b>PAS1</b>	1015	629	794					610			1345			879	344
<b>PAS2a</b>		*256	831					982						689	383
<b>PAS3</b>		1318	168					893			819			799	475
<b>NB1-S</b>	725	1023	590					690			1275			861	314
<b>NB1-D</b>	966	466	544					669			926			714	224
<b>NB3</b>		1049	414					461			678			650	290
<b>AK1-S</b>		817	602										1219	879	313
<b>AK1-D</b>					807		495			948				750	232
<b>PA-S</b>		460	826				1303			787				844	348
<b>PA-D</b>					758		520			1033				770	257
<b>HAC1</b>	583	41	1119					657			1202			720	468
<b>HAC2</b>		610	762					1148			1161			921	277
<b>HAC3</b>		440	524					1001			418			596	274
<b>KVK1</b>		999	518					257			670			611	310
<b>RAR1-S</b>				352		724			409			419		476	168
<b>RAR2</b>				169		503			349			218		310	149
<b>RWY1</b>					1353		659			2099			1888	1500	643
<b>ELIZ1</b>					4171		1844			1272			1378	2166	1359

\* The December 2000 sample was collected at Station PAS2 while construction activities were underway just upstream; all other samples were collected at Station PAS2a



**Figure 42: Mean ± standard deviation Total Suspended Sediment PCB concentrations (ng/g sed) at each sampling station.**

#### 5.4.5 PCB Homolog Group Distribution Patterns

Figure 43[a-p] shows the PCB homolog group distribution patterns at each sampling station during all sampling events for the separate dissolved and suspended sediment fractions. On average, 95% of the total dissolved PCB mass is distributed among the Mono- through Penta-homolog groups, with 70% of the mass concentrated in the Tri- and Tetra- homolog groups. In contrast, on average 92% of the total suspended sediment PCB mass is distributed among the Tri- through Hepta- homolog groups, with the maximum mass in the Tetra- and Penta- groups (combined 51%).

In the Passaic River (Figure 43[a-c]) there is little variability in the PCB homolog distribution patterns within each site, as well as among the sites. In addition, there is no consistent difference between the wet and dry weather surveys.

Likewise for the Hackensack River stations (Figure 43[d-f]), although there is slightly more variability in the PCB homolog distribution patterns among the surveys at each site.

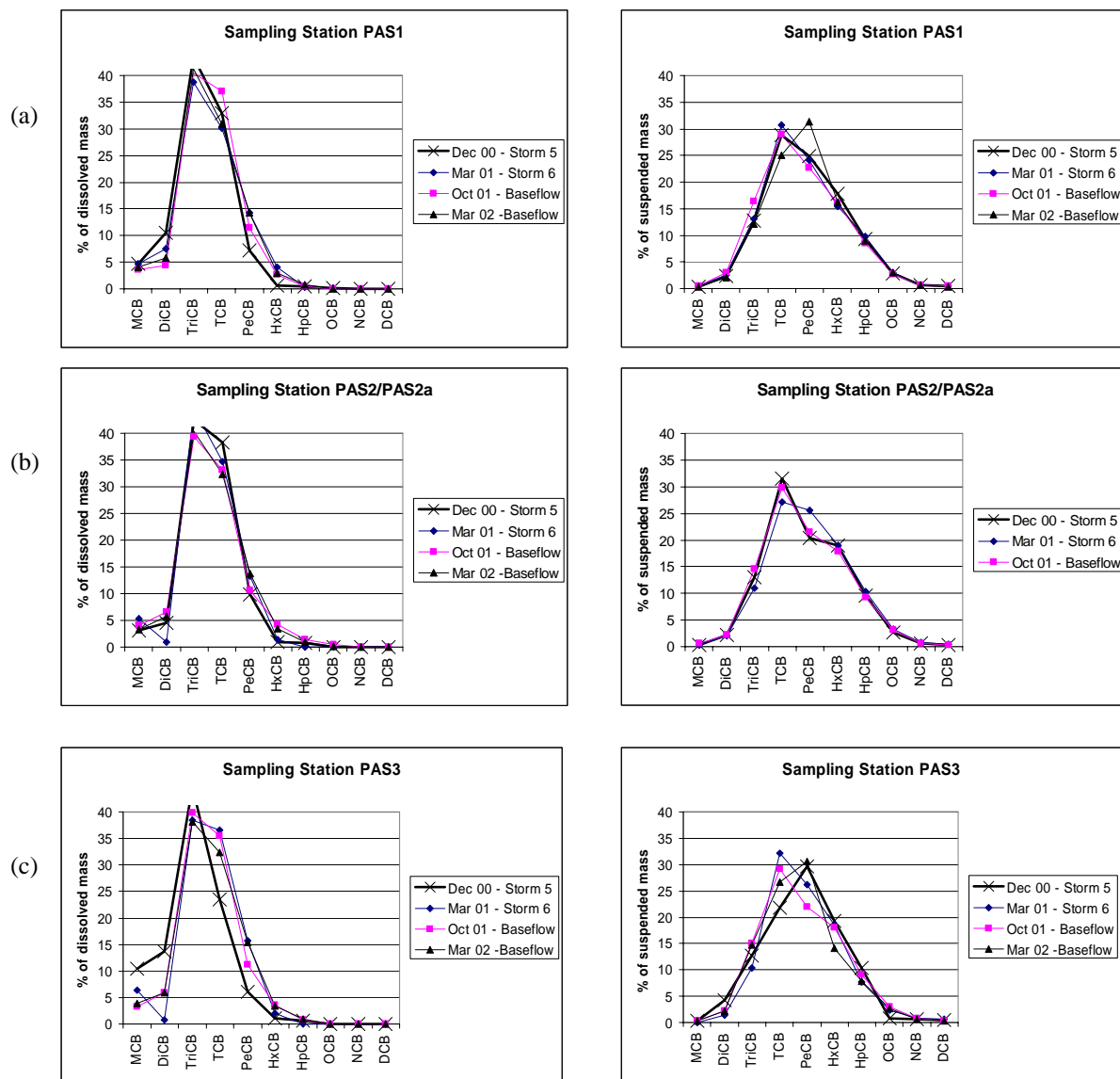
There appears to be little difference in the PCB homolog distribution patterns at Stations NB1-S, NB1-D, and NB3 (Figure 43[g-i]). During the March 2002 survey, the suspended sediment fraction at all three Newark Bay stations had elevated percentages of the Penta- homolog group. The dissolved fraction is dominated by the Tri- and Tetra- homologs, with secondary contributions from the Mono-, Di- and Penta- homologs. The suspended sediment fraction is dominated by Tetra-, Penta-, and Hexa- (and sometimes Tri-) homologs.

In the Raritan River (Figure 43[j-k]) there is little variability in the dissolved fraction PCB homolog distribution patterns, particularly at Station RAR1-S, and there is no consistent difference between wet and dry weather surveys. The suspended sediment fraction data has a fair amount of variability within each site, and there is no consistent wet vs. dry weather survey differences. The suspended sediment data at Station RAR2 is dominated by Penta- and Hexa- (and sometimes Tetra- and Hepta-) homologs, whereas Station RAR1-S is dominated by Tetra- and Penta- (and sometimes Tri- and Hexa-) homologs.

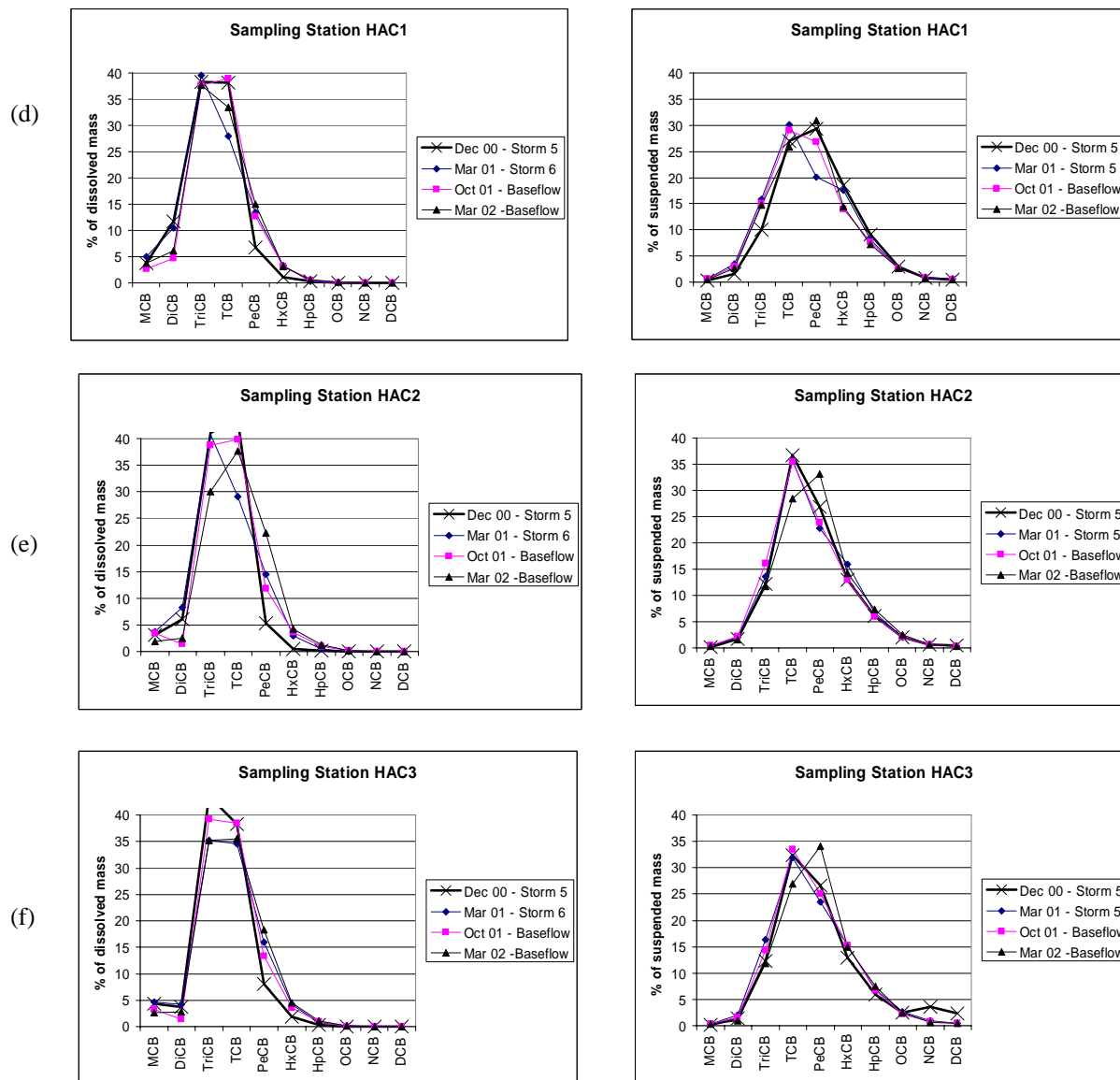
In the Rahway River (Figure 43[l]) and Elizabeth River (Figure 43[m]), the PCB homolog distribution patterns vary among the surveys, particularly for the suspended sediment fraction data. In addition, there is no consistent difference between the wet and dry weather surveys. The dissolved fraction data is dominated by the Tri-, Tetra- (and sometimes Penta-) homologs. The suspended sediment fraction data is dominated by the Tetra-, Penta-, Hexa- (and sometimes Hepta-) homologs.

At the lower Arthur Kill Station PA-S/D (Figure 43[n]) there is little variability (except for the May 2001 PA-S sample) and no consistent patterns in the wet vs. dry weather or shallow vs. deep suspended sediment fraction data. Likewise, for the dissolved fraction data (except for the Dec 2000 PA-S sample).

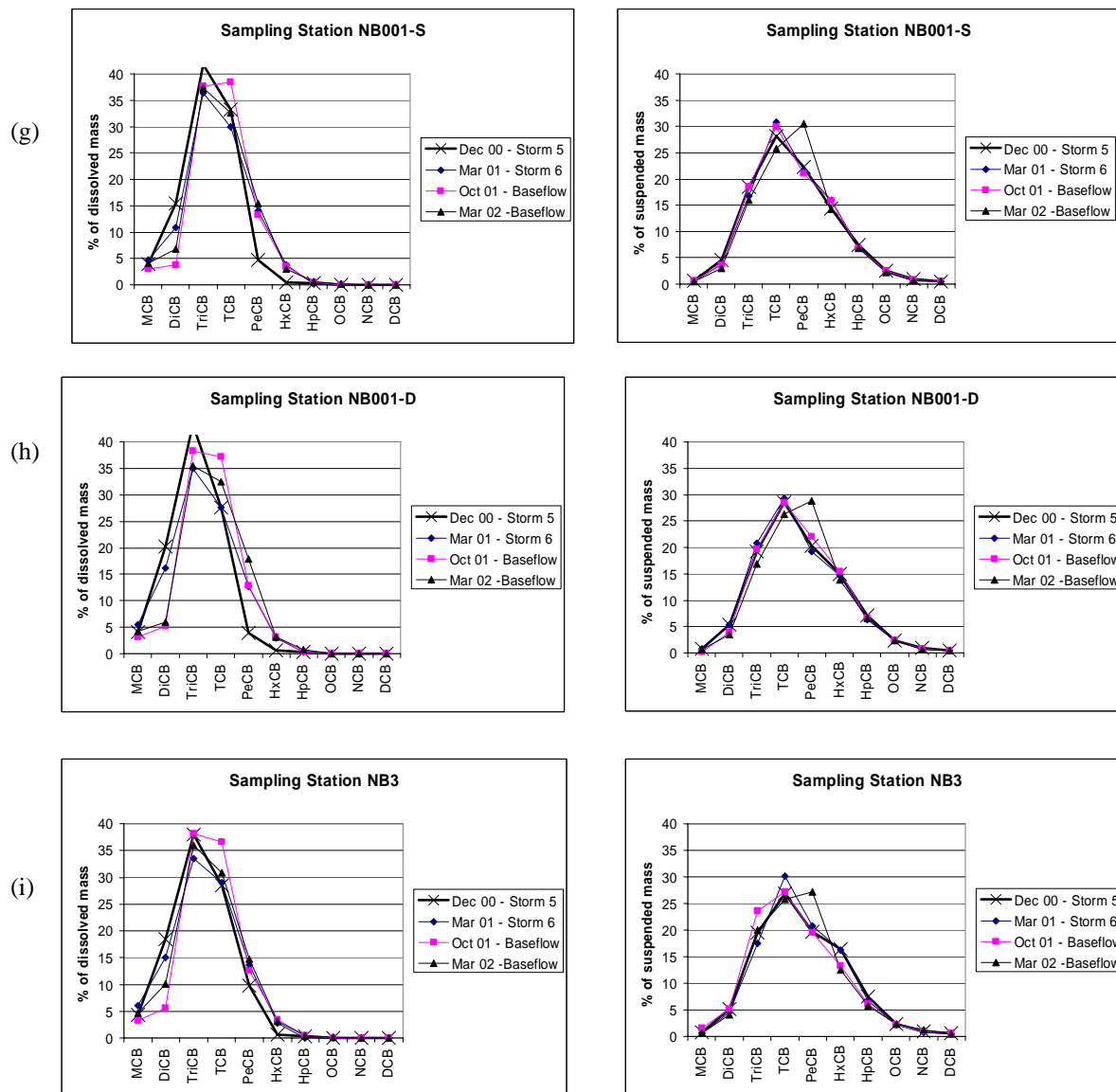
At the upper Arthur Kill stations AK1-S/D (Figure 43[o]) there is some variability in the suspended sediment fraction PCB homolog distribution patterns, particularly for the dominant Tetra- and Penta- (and secondary Tri-) homologs. However there are no consistent differences between the wet vs. dry weather or shallow vs. deep samples. The same can be said for the dissolved fraction data, which is dominated by Tri- and Tetra- homologs, with the Mono-, Di-, and Penta- homologs secondary contributors.



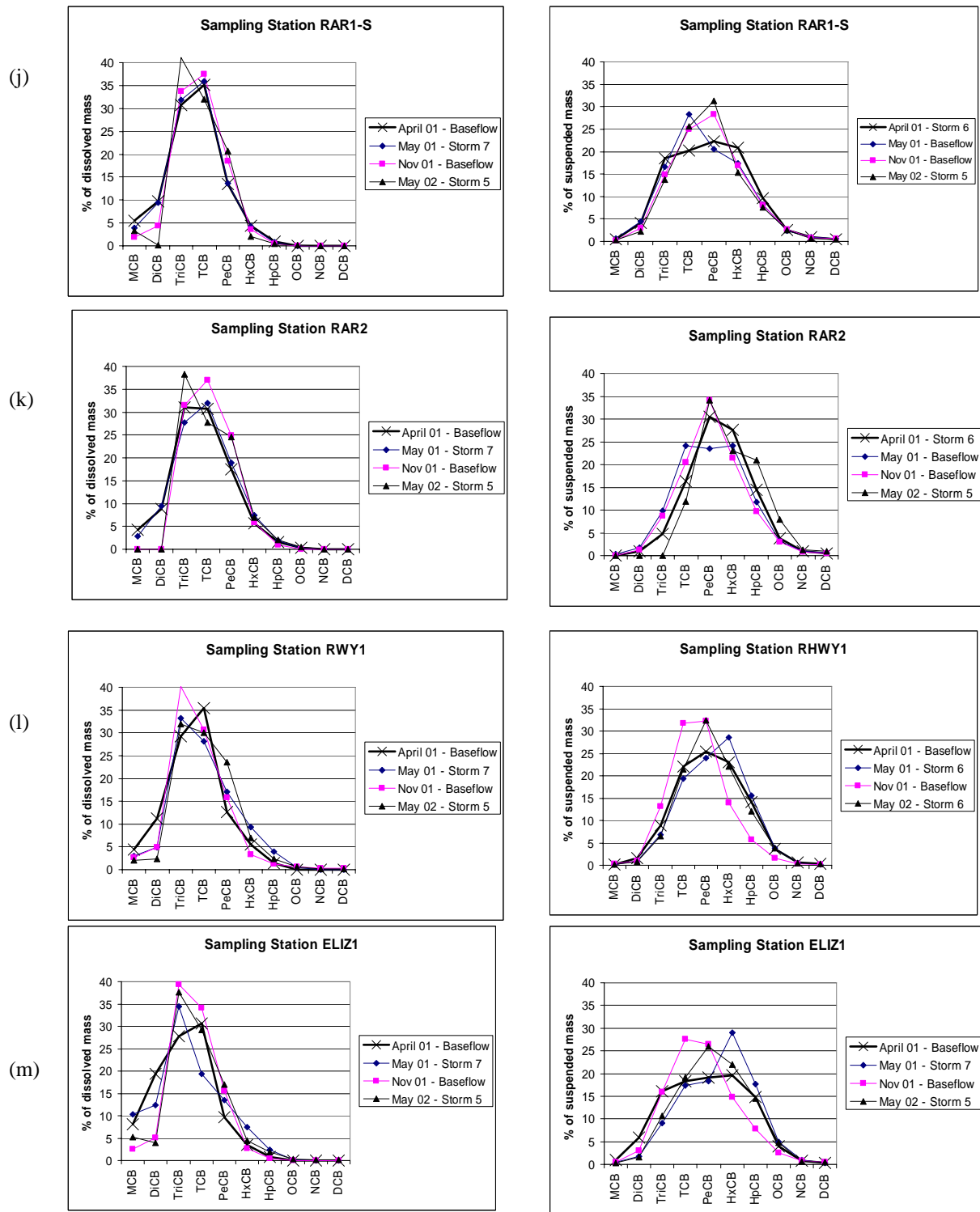
**Figure 43:** Distribution of the PCB mass in the dissolved and suspended sediment phases among the PCB homolog groups at each sampling station for each sampling survey. (a) PAS1, (b) PAS2, (c) PAS3, (d) HAC1, (e) HAC2, (f) HAC3, (g) NB001-S, (h) NB001-D, (i) NB3, (j) RAR1, (k) RAR2, (l) RWY, (m) ELIZ1, (n) PA-S and PA-D, (o) AK1-S and AK1-D, (p) KVK.



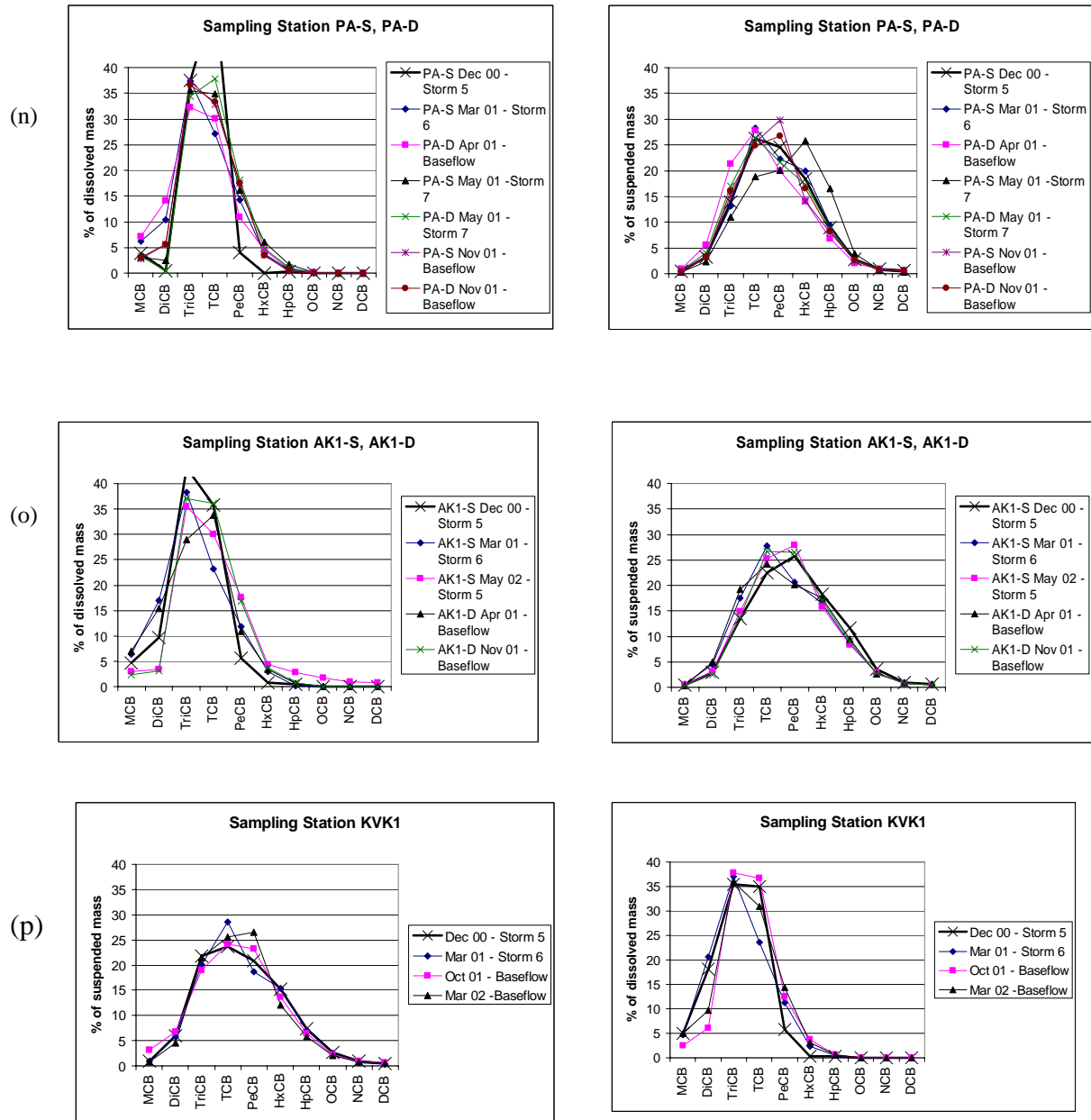
**Figure 43:** Distribution of the PCB mass in the dissolved and suspended sediment phases among the PCB homolog groups at each sampling station for each sampling survey. (a) PAS1, (b) PAS2, (c) PAS3, (d) HAC1, (e) HAC2, (f) HAC3, (g) NB001-S, (h) NB001-D, (i) NB3, (j) RAR1, (k) RAR2, (l) RWY, (m) ELIZ1, (n) PA-S and PA-D, (o) AK1-S and AK1-D, (p) KVK.



**Figure 43:** Distribution of the PCB mass in the dissolved and suspended sediment phases among the PCB homolog groups at each sampling station for each sampling survey. (a) PAS1, (b) PAS2, (c) PAS3, (d) HAC1, (e) HAC2, (f) HAC3, (g) NB001-S, (h) NB001-D, (i) NB3, (j) RAR1, (k) RAR2, (l) RWY, (m) ELIZ1, (n) PA-S and PA-D, (o) AK1-S and AK1-D, (p) KVK.



**Figure 43:** Distribution of the PCB mass in the dissolved and suspended sediment phases among the PCB homolog groups at each sampling station for each sampling survey. (a) PAS1, (b) PAS2, (c) PAS3, (d) HAC1, (e) HAC2, (f) HAC3, (g) NB001-S, (h) NB001-D, (i) NB3, (j) RAR1, (k) RAR2, (l) RWY, (m) ELIZ1, (n) PA-S and PA-D, (o) AK1-S and AK1-D, (p) KVK.



**Figure 43:** Distribution of the PCB mass in the dissolved and suspended sediment phases among the PCB homolog groups at each sampling station for each sampling survey. (a) PAS1, (b) PAS2, (c) PAS3, (d) HAC1, (e) HAC2, (f) HAC3, (g) NB001-S, (h) NB001-D, (i) NB3, (j) RAR1, (k) RAR2, (l) RWY, (m) ELIZ1, (n) PA-S and PA-D, (o) AK1-S and AK1-D, (p) KVK.



There is little variability and no consistent wet vs. dry weather pattern in the suspended sediment fraction data in the Kill van Kull (Figure 43[p]). The suspended sediment fraction PCB homolog distribution pattern is dominated by the Tri-, Tetra-, and Penta- homologs, with a secondary Hexa- contribution. There is more variability in the dissolved fraction patterns, particularly with the Mono-, Di-, Tetra-, and Penta- homologs.

Figure 44(a) shows the mean dissolved PCB homolog distribution patterns at the Passaic and Hackensack River, and Newark Bay, sampling stations. For any homolog group, there is less than 10% difference in the mean % composition among these nine sampling stations. However, while the Tri- homolog group dominates and comprises approximately 40% of the Total Dissolved PCBs at the Passaic River stations, Total Dissolved PCBs are evenly distributed among the Tri- and Tetra- groups (~37% each) in the Hackensack River. The Newark Bay data for the Tri- and Tetra- homolog groups appears to be a “mix” of the Passaic and Hackensack Rivers.

Figure 44(b) shows the mean dissolved PCB homolog distribution patterns for the Newark Bay, Arthur Kill, and Kill van Kull stations. Again, there is less than 10% difference in the mean % composition for any homolog group among these nine sampling stations. However, the Newark Bay (NB3 and NB1-D) and the Kill van Kull Stations have relatively high % Di- homolog composition (~13%).

Figure 45(a) shows the mean suspended sediment fraction PCB homolog distribution patterns at the Passaic and Hackensack River, and Newark Bay, sampling stations. Again, there is less than 10% difference in the mean % composition for any homolog group among these nine sampling stations. However, there appear to be some consistent differences among the stations:

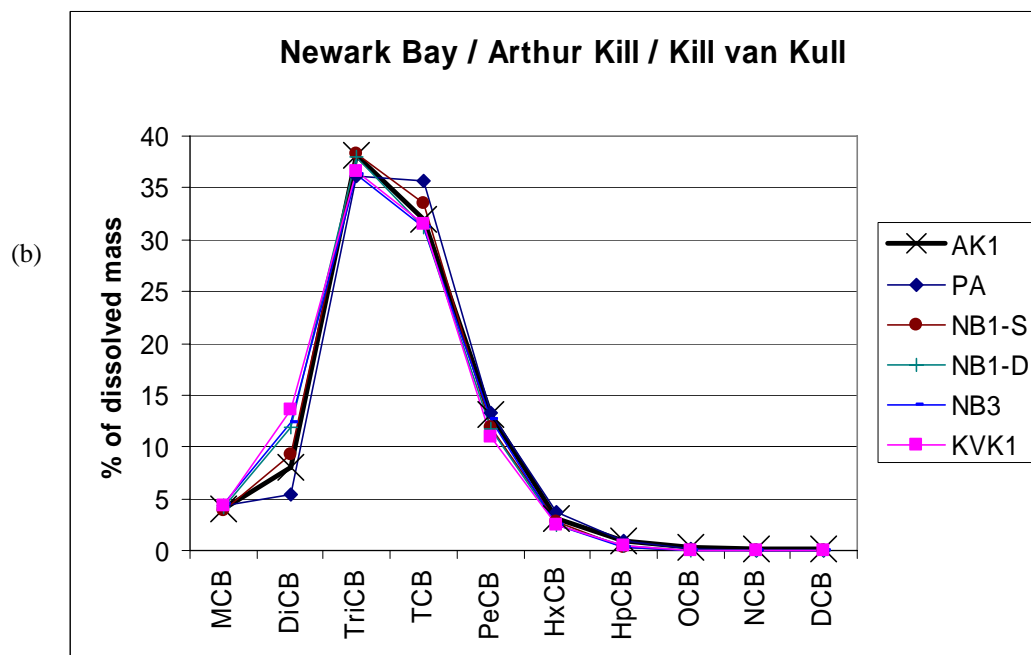
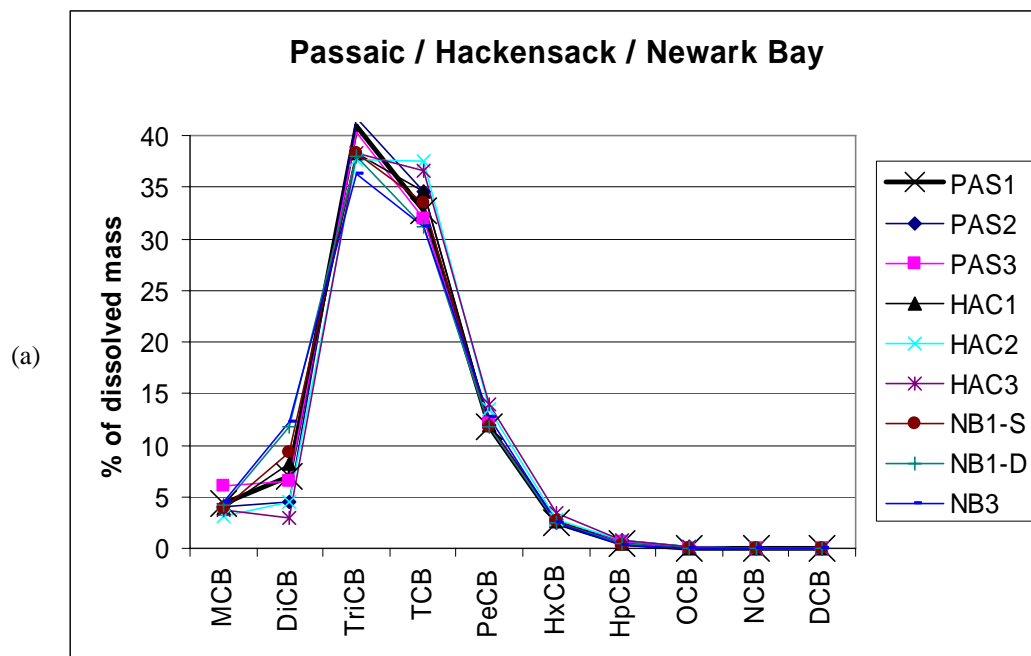
- (a) the Newark Bay stations tend to have a greater % composition of the Mono- through Tri- homologs;
- (b) the Hackensack River stations tend to have a greater % composition of the Tetra- and Penta- homologs; and
- (c) the Passaic River stations tend to have a greater % composition of the Hexa- and Hepta- homologs.

Figure 45(b) shows the mean suspended sediment fraction PCB homolog distribution patterns at the Newark Bay, Arthur Kill, and Kill van Kull stations. There is less than 10% difference in the mean % composition for any homolog group among these nine sampling stations. However, the Newark Bay stations tend to have a greater % composition of the Tetra- homolog group than the other stations. In contrast, the Arthur Kill stations tend to have a greater % composition of the Hexa- and Hepta- homologs.

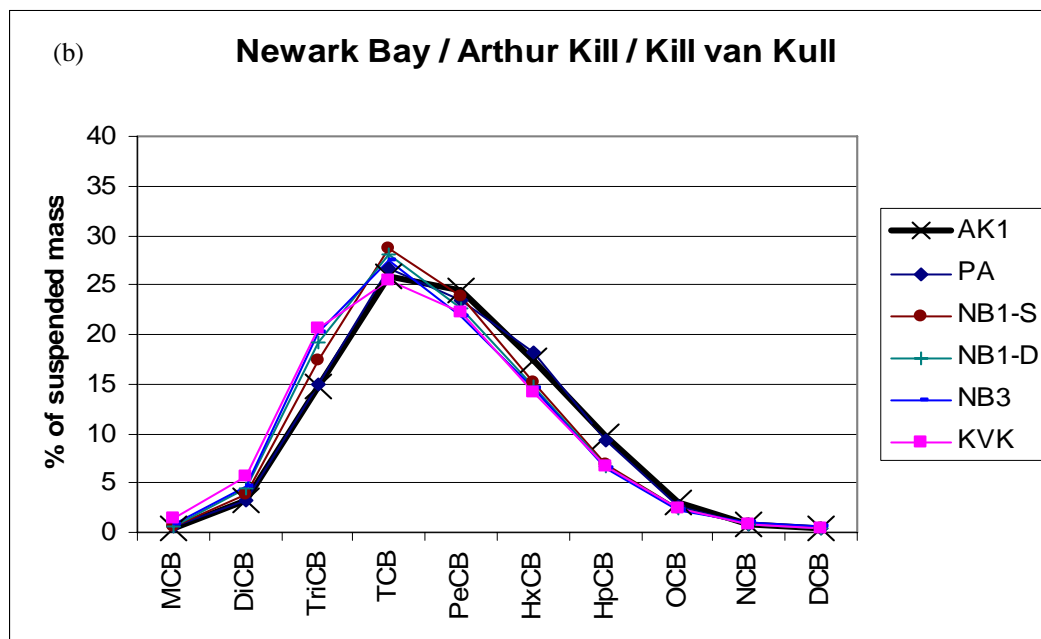
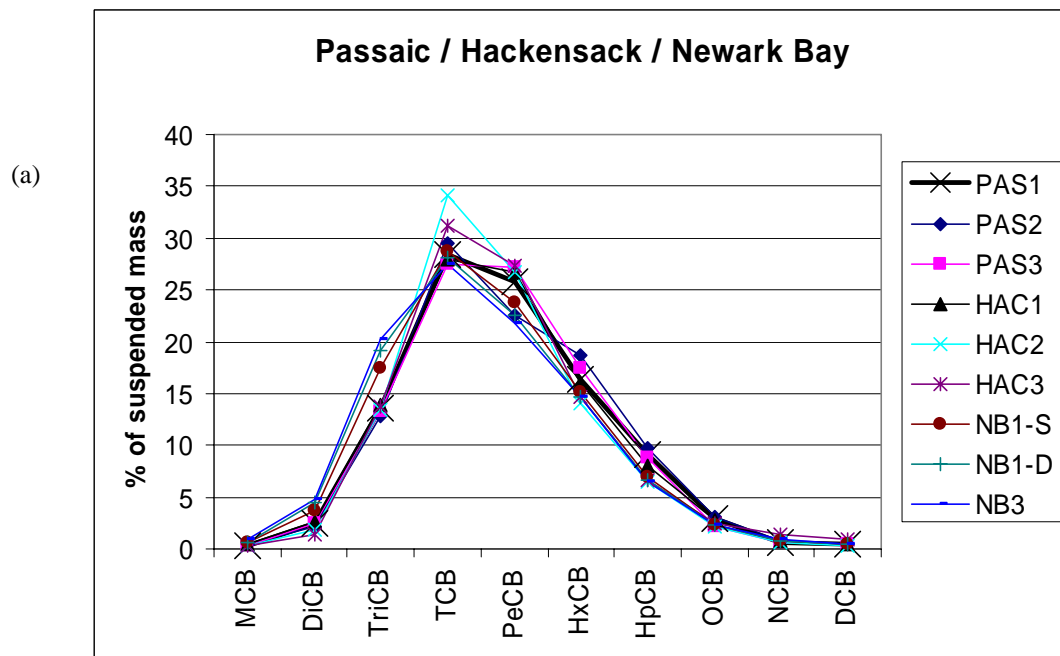
Overall, there is little difference in the mean dissolved and suspended sediment PCB homolog distribution patterns in the Passaic and Hackensack Rivers, and in the estuarine areas of Newark Bay, the Arthur Kill, and the Kill van Kull. However, there do appear to be some slight differences/trends that may be indicative of potential PCB sources and/or suspended sediment and contaminant transport in the harbor.

The PCB homolog distribution patterns are variable for the various Rahway and Elizabeth River surveys (see Figure 43[l-m]). Figure 46(a) shows the dissolved PCB homolog distribution during selected dry weather (April 2001) and wet weather (May 2001) surveys in the Elizabeth and Rahway Rivers, and at Station AK1-D. An elevated % composition of mono-chlorinated homologs (~10%) are measured in the Elizabeth River compared to the Rahway River and Station AK1-D. The tri-chlorinated group is the most abundant (33-36%) during the May 2001 wet weather surveys at all three stations, whereas the tetra-chlorinated group (~34%) is the most abundant during the April 2001 baseflow surveys. Figure 46(b) shows the suspended sediment PCB homolog distribution patterns during these surveys. There is a large amount of variability in the % composition of the Tri- through Hepta- homolog groups in the samples.

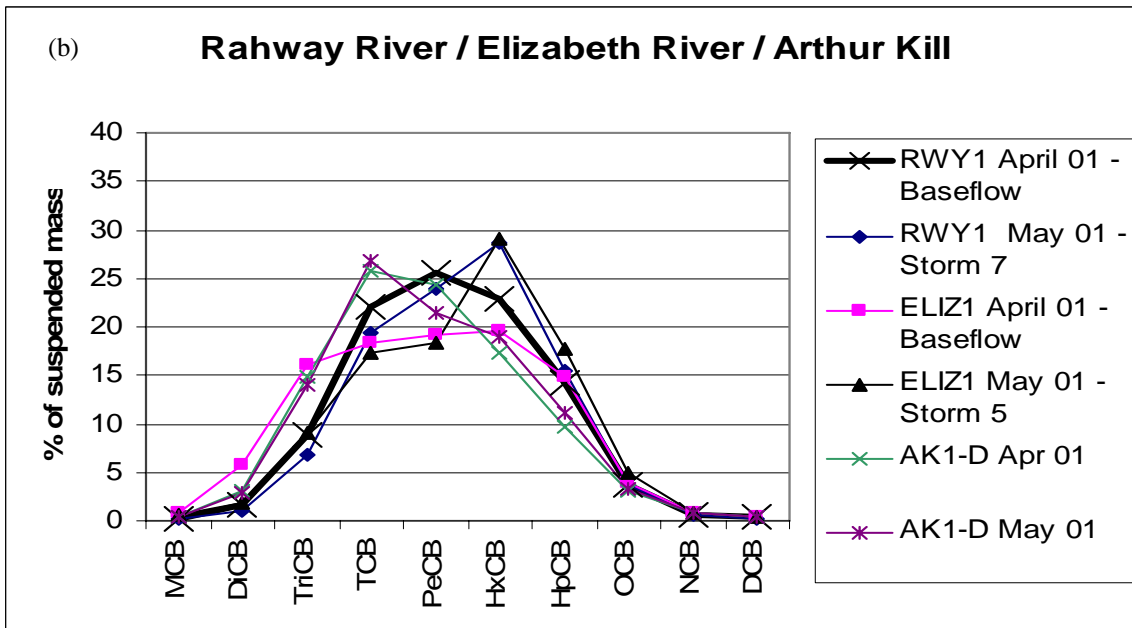
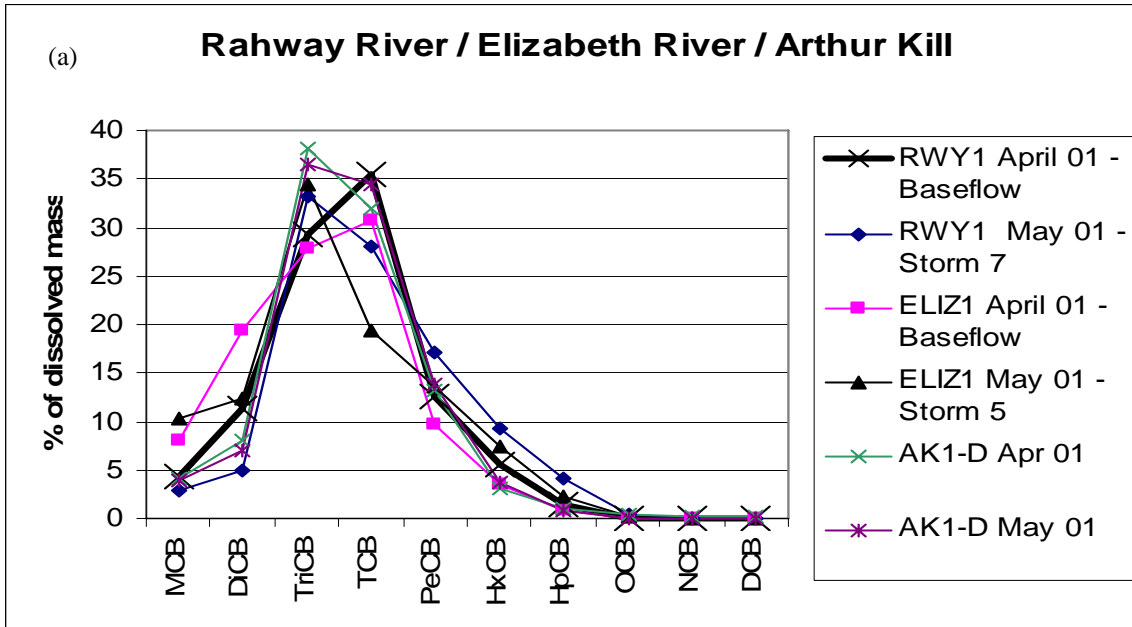
Figure 47(a) shows the dissolved PCB homolog distribution during selected dry weather (April 2001) and wet weather (May 2001) surveys in the Raritan River, and the mean at Station PA-S. The tetra-chlorinated group is the most abundant during both the April 2001 and the May 2001 surveys in the Raritan River (30.6-35.9%, with slightly higher % composition at Station RAR1-S), with the tri-chlorinated group secondary (27.6-31.8%). These two homolog groups are co-dominant at Station PA-S (~37%). There appears to be little difference in the Raritan River dissolved PCB homolog distribution patterns due to different weather conditions. Figure 47(b) shows the suspended sediment PCB homolog distribution patterns during these surveys. There is a large amount of variability in the % composition of the Tri- through Hepta- homolog groups in the samples from these surveys.



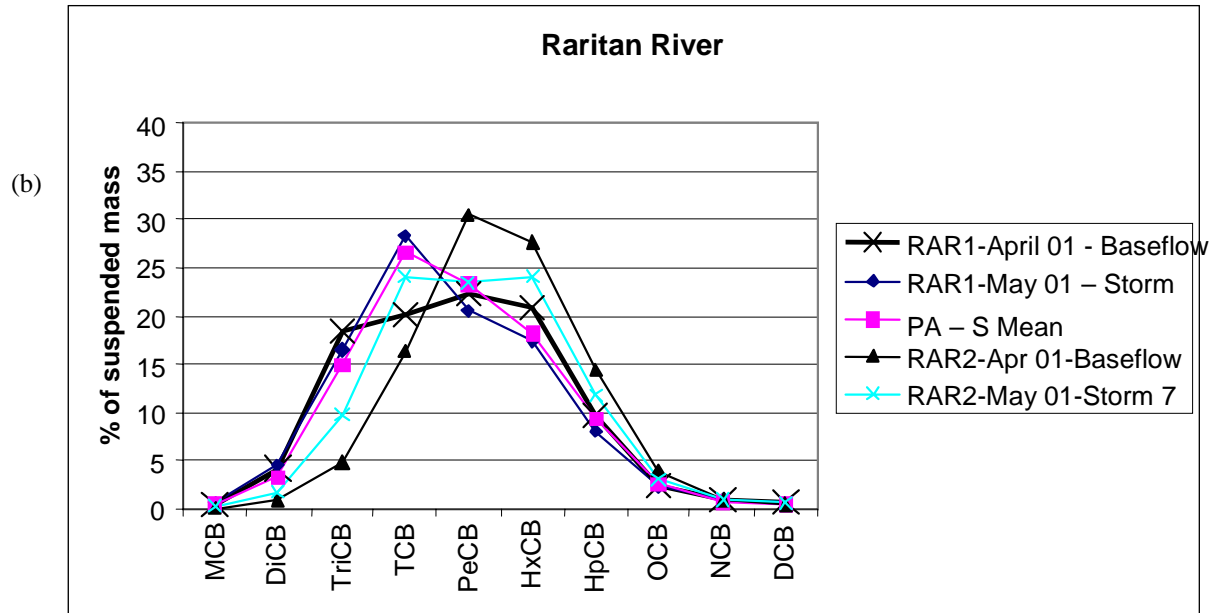
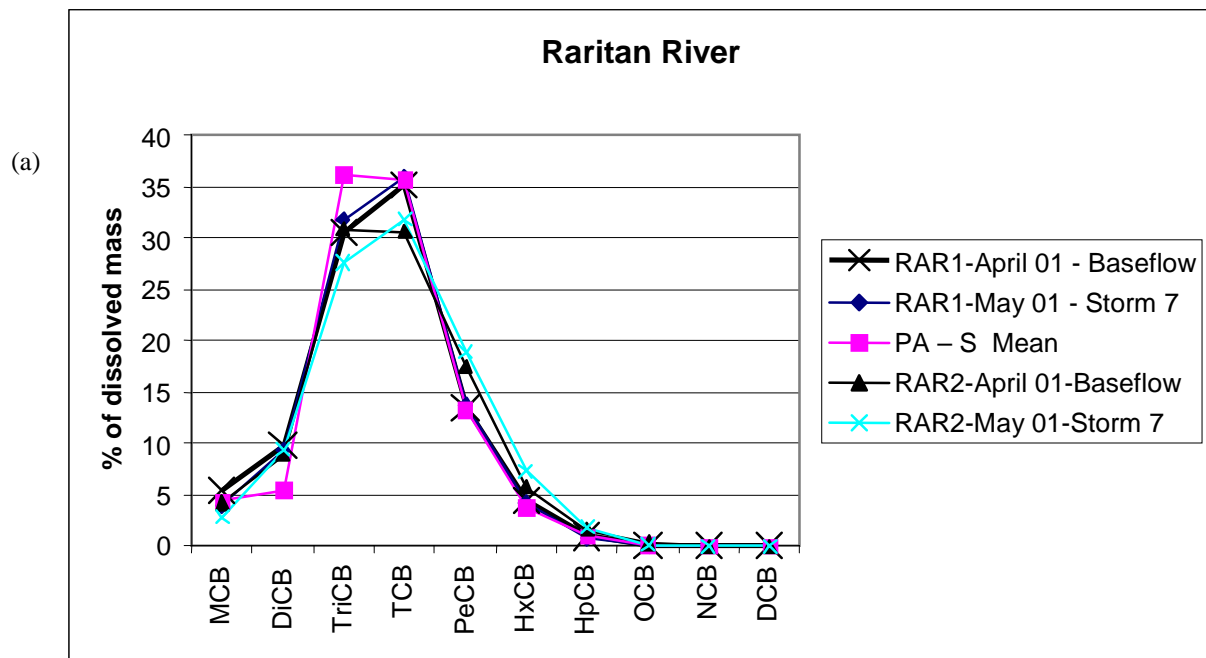
**Figure 44:** Mean distribution of the Total Dissolved PCB mass among the homolog groups (a) Passaic and Hackensack Rivers, Newark Bay stations; (b) Newark Bay, Arthur Kill, and Kill van Kull stations.



**Figure 45:** Mean distribution of the Total Suspended Sediment PCB mass among the homolog groups (a) Passaic and Hackensack Rivers, Newark Bay stations; (b) Newark Bay, Arthur Kill, and Kill van Kull stations.



**Figure 46:** Distribution of PCB mass among the homolog groups for selected sampling surveys (April 2001, May 2001) in the Rahway and Elizabeth Rivers, and at Station AK1-D (a) dissolved PCBs, (b) suspended sediment PCBs.



**Figure 47:** Distribution of PCB mass among the homolog groups for selected sampling surveys (April 2001, May 2001) in the Raritan River, and the mean at Station PA-S (a) dissolved PCBs, (b) suspended sediment PCBs.

#### 5.4.6 PCBs - Conclusions

- (1) There is little variation in the mean Total Dissolved PCB concentrations throughout the study area (range = 1,461 to 5,517 pg/L, overall mean =  $3,853 \pm 2,985$  pg/L). However, concentrations tended to be lower at the Raritan River and Perth Amboy stations (range = 1,461 to 2,175 pg/L).
- (2) Mean Total Suspended Sediment PCB concentrations (pg/L) were elevated in the Passaic (13,066 – 24,224 pg/L), mid/upper Hackensack (11,362 – 19,188 pg/L), Rahway (51,219 pg/L), and Elizabeth (20,982 pg/L) Rivers. Mean Total Suspended Sediment PCBs were lower in the Raritan River and estuarine areas (range = 2,527 to 9,175 pg/L). Over all sampling stations and sampling events, there was moderate correlation between Total Suspended Sediment PCBs (pg/L) and SS.
- (3) Mean Total Suspended Sediment PCB concentrations (ng/g sed) were highest in the Elizabeth (2,166 ng/g sed) and Rahway (1,500 ng/g sed) Rivers, and lowest in the Raritan River (310 – 476 ng/g sed). Mean concentrations were similar at the other sampling stations (range = 596 – 921 ng/g sed).
- (4) On average, 95% of the Total Dissolved PCB mass is distributed among the Mono- through Penta- homolog groups, with 70% of the mass concentrated in the Tri- and Tetra- homolog groups. In contrast, on average 92% of the Total Suspended Sediment PCB mass is distributed among the Tri- through Hepta- homolog groups, with the maximum mass (51%) in the Tetra- and Penta- groups.
- (5) There is little difference in the mean dissolved and suspended sediment PCB homolog distribution patterns in the Passaic and Hackensack Rivers, and in the estuarine areas of Newark Bay, the Arthur Kill, and the Kill van Kull. However, there do appear to be some slight differences/trends that may be indicative of potential PCB sources and/or suspended sediment and contaminant transport in the harbor.
- (6) PCB homolog distribution patterns in both the dissolved and suspended sediment phases show that the Elizabeth and Rahway River sampling stations tend to shift towards the higher (Penta- through Hepta-) homolog groups compared with the Passaic and Hackensack Rivers. This trend may be indicative of different PCB sources.
- (7) The New Jersey Saline Human Health Water Quality Criteria (WQC) for Total PCBs (suspended + dissolved fractions; 64 pg/L) was exceeded by every sample collected as part of this study. The New Jersey Saline Aquatic Chronic WQC for Total PCBs (suspended + dissolved fractions; 30 ng/L) was exceeded by the mean concentration at the Rahway River sampling location (due to high concentrations during two wet weather-high river flow sampling events), in two (2) of the Elizabeth River and Station PAS1 samples, and in one (1) sample at Stations PAS2, PAS3, and HAC3. This WQC was not exceeded in any sample collected in the Raritan River, mid/lower Hackensack River, and in the estuarine areas of the harbor. The Long et al. (1995) sediment Effects Range Low (ERL = 23 ng/g sed) guideline value was exceeded by every sample collected as part of this study; the Effects Range

Median (ERM = 180 ng/g sed) guideline value was exceeded by every sample except one (1) at Stations PAS3, HAC1, and RAR2. These exceedances of the New Jersey WQC and Long et al. (1995) guidance values indicate that PCBs may have significant adverse impacts on overall water quality in the study area.



## 5.5 Dioxins – Furans

### 5.5.1 Sample Analysis

A modified version of USEPA Method 1613B was used to measure the particulate phase (suspended sediment) concentrations of 17 of the 2,3,7,8-substituted PCDD/Fs. This method used high-resolution gas chromatography and mass spectrometry (HRGC/HRMS) with isotope dilution to analyze the TOPS filter samples. The detection limit achieved for each PCDD/F congener varied among the samples, due to analytical differences as well as differences in sample size. Considering all congeners, detection limits for the suspended sediment phase (TOPS filters) samples ranged between 0.0014 and 1.84 pg/L, with a mean  $\pm$  standard deviation of  $0.089 \pm 0.295$  pg/L; and between 0.0346 and 25.93 pg/g sed, with a mean  $\pm$  standard deviation of  $3.45 \pm 4.73$  pg/g sed.

### 5.5.2 NJTRWP Blank Correction

The sample data was subjected to a preliminary Quality Assurance Verification Review. In addition, because of the nature of the samples and the trace concentrations expected for the target analytes, a “maximum blank” approach was developed to assess the impact of background contamination on the usability of the sample data. One (1) TOPS Filter set Field Blank was collected at each sampling location. The TOPS Filter Field Blank was collected by exposing a set of TOPS filters to the surrounding air while the TOPS filters that were used for sampling were installed and removed from the sampling equipment. The Field Blank from one of the sites in each survey was analyzed in the same manner as its associated samples; the remaining Field Blanks were archived. At least one (1) laboratory Method Blank was also prepared and analyzed by the analytical laboratory for each Sample Delivery Group (SDG). That blank having the largest value (the “maximum blank”) was used to assess the effect of background contamination on the sample data for that survey. In order for a sample result to be usable, it must have been at least five times (5X) greater than the “maximum blank”. No other blank correction was performed on the sample data.

No sample data was impacted by Method or Field Blank contamination.

### 5.5.3 Suspended Sediment PCDD/F Concentrations

Tables 28 and 29 show the total dioxin (tPCDD) concentrations in pg/L and pg/g sed, respectively, from all sampling stations during all sampling events. Mean tPCDD concentrations (pg/L; Table 28) were highest in the Rahway ( $619 \pm 607$  pg/L) and Elizabeth ( $331 \pm 385$  pg/L) Rivers. Mean concentrations were also elevated at Station RAR2 ( $249 \pm 42$  pg/L), the Passaic River stations (110 to 191 pg/L), Station HAC3 ( $159 \pm 107$  pg/L), and Station PA-S ( $112 \pm 100$  pg/L). Mean tPCDD concentrations were less than 100 pg/L at the other sampling stations.

The coefficient of variation of the tPCDD data (pg/L) ranged between 0.169 and 1.239. The lowest variability (0.169) was observed at Station RAR2 where there was consistently a very high concentration and percentage of OCDD in the samples (see below). Variability was highest at Station PAS3 (1.239); however, the samples collected during wet weather surveys at this Station (Oct 2001 and March 2002) consistently had much higher concentrations than those collected during dry weather surveys (December 2000 and March 2001). Variability was also high in the Elizabeth (1.164) and Rahway (0.98) Rivers, but there was no consistent wet-dry weather concentration pattern. The high variability at Stations HAC2 (1.072) and PAS2 (1.116) was the result of one high sample concentration (October 2001). Omitting these six stations, the coefficient of variation at the remaining stations ranged between 0.321 and 0.889.

The highest mean tPCDD (ng/g sed; Table 29 and Figure 48) concentrations were measured at Station RAR2 ( $33.4 \pm 7.4$  ng/g sed; due to OCDD – see below) and in the Elizabeth River ( $27.5 \pm 13.4$  ng/g sed). Elevated tPCDD concentrations were also found in the Rahway River ( $14.1 \pm 6.3$  ng/g sed), and at the lower Arthur Kill stations (PA-S =  $12.1 \pm 9.0$  ng/g sed; PA-D =  $11.8 \pm 3.2$  ng/g sed). Mean tPCDD concentrations were less than 11 ng/g sed at the other stations.

The coefficient of variation of the tPCDD data (pg/g sed) ranged between 0.186 and 0.767. The lowest variability (0.186) was found at Station PAS3, which, in contrast, had high variability in tPCDD (pg/L) concentrations due to consistently elevated concentrations during wet weather events (discussed above). In addition, SS levels were consistently higher at this station during wet weather events (see Table 5). Finally, the PCDD congener distribution patterns of all the PAS3 samples were similar, differing only in the % 2,3,7,8-TCDD. This suggests that the source(s) of PCDDs to Station PAS3 is(are) the same during dry and wet weather conditions, and that sediments from this source(s) are resuspended/discharged to the river in greater quantities during wet weather events.

Mean tPCDF concentrations (pg/L; Table 30) were highest ( $> 25$  pg/L) in the Passaic, Hackensack, Rahway, and Elizabeth Rivers, and lower ( $< 8$  pg/L) in the Kills, lower Newark Bay (Station NB3), and Raritan River. Mean tPCDF concentrations were at intermediate levels (18-20 pg/L) in upper Newark Bay (Stations NB1-S/D).

The coefficient of variation of the tPCDF data (pg/L) ranged between 0.319 and 1.404. Values  $> 1.0$  were found at the same stations as was observed for tPCDD concentrations (see above). Omitting these stations, the coefficient of variation at the remaining stations ranged between 0.319 and 0.929.

Mean tPCDF concentrations (pg/g sed; Table 31 and Figure 48) were typically less than 2 ng/g sed, with the highest levels observed at Station HAC2 ( $3.3 \pm 2.2$  ng/g sed) and in the Elizabeth River ( $3.0 \pm 1.3$  ng/g sed). Compared to the tributaries, mean tPCDF levels were lower (typically less than 1 ng/g sed) in the estuarine areas of lower Newark Bay (Station NB3) and the Kills, and in the Raritan River. The coefficient of variation of the tPCDF data (pg/g sed) ranged between 0.093 and 0.808. The lowest variability (0.093) was observed at Station NB3 and was atypical; variability at the remaining stations ranged between 0.326 and 0.808.

Mean Total PCDD/F concentrations (pg/L; Table 32) were largely determined by the tPCDD concentrations, and were highest in the Rahway ( $665 \pm 652$  pg/L) and Elizabeth ( $362 \pm 417$  pg/L) Rivers. Mean concentrations were also elevated at Stations PAS1 ( $244 \pm 213$  pg/L), RAR2 ( $253 \pm 43$  pg/L), and HAC3 ( $201 \pm 136$  pg/L). Mean tPCDD/F concentrations were less than 170 pg/L at the other sampling stations. The elevated mean tPCDD/F concentration at Station RAR2 was largely the result of consistently very high OCDD concentrations (mean =  $241.4 \pm 40.3$  pg/L) that accounted for 95.4% of the mean tPCDD/F at this station.

The coefficient of variation of the tPCDD/F data (pg/L) ranged between 0.168 and 1.266, almost identical to that found for the tPCDD (pg/L) data (see above). This range is also similar to that found for the Total Suspended Sediment PCB data (pg/L; 0.176 – 1.026). Among those stations with a large ( $> 1.0$ ) coefficient of variation, only Station HAC2 had a relatively low mean %OCDD (59.3%) compared with the overall mean %OCDD at all of the sampling stations (77.4%). The lowest coefficient of variation was found at Station RAR2 (0.168) which was consistently dominated by OCDD (95.4%, see above).

Over all sampling stations and sampling events, there was moderate correlation between Total Suspended Sediment PCDD/F (pg/L) and SS (Total SS-PCDD/F [pg/L] =  $6.4 * SS$  [mg/L] + 39.3;  $r = 0.65$ ).

Total PCDD/F concentrations (Table 33, pg/g sed and Figure 49, ng/g sed) were largely determined by the tPCDD concentrations, with the highest mean levels found in the Elizabeth River ( $30.4 \pm 14.6$  ng/g sed) and at Station RAR2 ( $34.1 \pm 7.4$  ng/g sed). Elevated mean tPCDD/F concentrations ( $>11$  ng/g sed) were observed in the Rahway River, lower Arthur Kill (Stations PA-S/D), mid-Passaic River (Station PAS2), and in the lower Raritan River (Station RAR1-S). Mean tPCDD/F concentrations were less than 10 ng/g sed at the remaining stations, and showed little variability within the Passaic and Hackensack Rivers, Newark Bay, and the upper Arthur Kill (Stations AK1-S/D).

The coefficient of variation of the tPCDD/F data ranged between 0.218 and 0.891, and was slightly more variable than that of the Total Suspended Sediment PCB data (range = 0.252 – 0.581). The lowest coefficient of variation was found at Station RAR2 (0.218) which was consistently dominated by OCDD (see above).

Over all sampling stations, there was no correlation ( $r = -0.09$ ) between Total Suspended Sediment PCDD/Fs (pg/g sed) and SS (mg/L).

Table 34 shows the tPCDD/F-OCDD (without OCDD) concentrations (pg/g sed) from all sampling stations during all sampling events. Figure 49 shows the mean ( $\pm 1$  standard deviation) tPCDD/F and tPCDD/F-OCDD (without OCDD) concentrations at each sampling station. Overall, approximately 77% of the Total PCDD/F is OCDD. The highest mean tPCDD/F-OCDD concentration was in the Elizabeth River ( $5.2 \pm 2.3$  ng/g sed). Elevated mean tPCDD/F – OCDD levels were found in the mid/lower Hackensack River (HAC2 =  $3.85 \pm 2.59$  ng/g sed; HAC1 =  $3.34 \pm 1.94$  ng/g sed), lower Passaic River (PAS1 =  $2.69 \pm 1.41$  ng/g sed), and in upper Newark Bay (NB1-S =  $2.60 \pm 1.45$  ng/g sed; NB1-D =  $2.23 \pm 1.66$  ng/g sed). Mean tPCDD/F-OCDD concentrations were typically less than 2 ng/g sed at the remaining stations.

The coefficient of variation of the tPCDD/F-OCDD data ranged between 0.145 and 0.805, comparable to the range of variation seen in the tPCDD/F data (range = 0.218 – 0.891). The lowest coefficient of variation was found at Station NB3 (0.145), with the highest variability at Station PAS2 (0.805).

The highest mean PCDD/F-OCDD concentration (ng/g POC; data not shown) was found at Station PAS1 ( $162 \pm 282$  ng/g POC), with an elevated mean at Station HAC1 ( $76.6 \pm 64$  ng/g POC). As was seen with the PCBs, the POC-normalized concentrations were elevated throughout the sampling area in the October 2001 survey; omitting this event from the calculation of mean concentrations lowers the mean at Station PAS1 to 34.4 ng/g POC and that at Station HAC1 to 55.0 ng/g POC. Mean values at the remaining stations were less than 57 ng/g POC, with the lowest values at Station RAR1-S (10.4 ng/g POC).

The highest mean 2,3,7,8-TCDD concentrations (pg/g sed; Table 35) were found in the lower Passaic River (Station PAS1 =  $279 \pm 176$  pg/g sed), with elevated levels in the mid/upper Passaic River (Stations PAS2/3; 141 to 201 pg/g sed), upper Newark Bay (Station NB1-S/D; 83 to 98 pg/g sed) and the lower Hackensack River (Stations HAC1/2 = 77 to 114 pg/g sed). The major source of this 2,3,7,8-TCDD has been attributed to the Diamond Alkali (Lister Avenue, Newark) site located on the banks of the lower Passaic River. In addition, elevated levels of 2,3,7,8-TCDD were also found in the Elizabeth River ( $65.8 \pm 58.1$  pg/g sed). Mean 2,3,7,8-TCDD levels were less than 35 pg/g sed at the remaining stations.

The coefficient of variation of the 2,3,7,8-TCDD data (pg/g sed) ranged between 0.162 and 1.274. Variability was lowest (0.162) at Station NB3. Variability was similar at Stations PAS1 (0.632), HAC1 (0.585) and NB1-S (0.627), and increased in the upstream direction in both the Passaic (PAS2 = 0.894, PAS3 = 1.274) and Hackensack (HAC2 = 0.685, HAC3 = 0.815) Rivers. The highest variability in 2,3,7,8-TCDD concentrations was found at Station PAS3 (1.274), which contrasts with the very low variability in tPCDD (pg/g sed) levels at this station (see above). Variability was also high ( $> 1.05$ ) in the lower Arthur Kill (Stations PA-S/D) and at Station RAR2, but there was no consistent wet-dry weather pattern in concentrations at these stations.

Table 36 presents the mean 2,3,7,8-TCDD concentrations (pg/L) at each sampling station. The highest mean concentration was found at the lower Passaic River Station PAS1 ( $7.29 \pm 6.75$  pg/L), with elevated concentrations at Stations PAS2 ( $4.67 \pm 6.43$  pg/L) and PAS3 ( $4.45 \pm 7.15$  pg/L). Mean 2,3,7,8-TCDD concentrations were higher in upper Newark Bay and the Hackensack River (0.96 to 1.57 pg/L) compared to the remaining stations (less than 0.60 pg/L).

The coefficient of variation of the 2,3,7,8-TCDD data (pg/L) ranged between 0.365 and 1.609, and was generally higher compared to the 2,3,7,8-TCDD pg/g sed data. Variability was lowest in the Kill Van Kull (0.365) and at Station NB3 (0.370). Variability was similar at Stations PAS1 (0.926), HAC1 (0.904) and NB1-S (0.821), and increased in the upstream direction in both the Passaic (PAS2 = 1.377, PAS3 = 1.609) and Hackensack (HAC2 = 1.159, but HAC3 = 0.725) Rivers. The highest variability in 2,3,7,8-TCDD concentrations was found at Station PAS3 (1.609), which also had high variability in 2,3,7,8-TCDD (pg/g sed) and tPCDD (pg/L) levels at this station (see above). Variability was also high ( $> 0.91$ ) in the Elizabeth River, at the lower

Arthur Kill (Stations PA-S/D), and at Station RAR2, but there was no consistent wet-dry weather pattern in concentrations at these stations

**Table 28:** Total Suspended Sediment PCDD Concentration (pg/L)

	6/20-22/00	12/13-15/00	3/13-15/01	4/12/01	4/25/01	5/15/01	5/24/01	10/17-19/01	10/3/01	11/6/01	3/12-14/02	3/27/02	5/14/02	Mean	Std. Dev.
<b>PAS1</b>	376.3	29.4	96.0					359.5			93.5			191.0	163.8
<b>PAS2a</b>		*	54.8					292.6			69.9			110.3	123.1
<b>PAS3</b>		15.0	11.0					351.9			138.5			129.1	159.9
<b>NB1-S</b>	82.1	20.9	38.5					101.6			30.1			54.6	35.2
<b>NB1-D</b>	103.9	13.0	40.2					78.9			32.7			53.7	36.8
<b>NB3</b>		10.4	29.2					35.1			17.9			23.1	11.1
<b>AK1-S</b>		29.6	70.7										82.6	61.0	27.8
<b>AK1-D</b>					88.0		51.9			52.7				64.2	20.6
<b>PA-S</b>		14.6	157.8				230.2			46.1				112.2	99.8
<b>PA-D</b>					70.0		127.5			43.6				80.4	42.9
<b>HAC1</b>	132.7	8.1	84.5					103.9			28.6			71.6	52.0
<b>HAC2</b>		17.6	50.9					190.0			35.5			73.5	78.8
<b>HAC3</b>		44.7	193.9					290.6			107.4			159.2	106.8
<b>KVK1</b>		19.5	53.9					41.5			34.8			37.4	14.3
<b>RAR1-S</b>				193.7		51.3			25.6			123.3		98.5	75.8
<b>RAR2</b>				242.2		204.2			305.4			242.6		248.6	41.9
<b>RWY1</b>					182.6		924.2			47.5			1323.2	619.4	607.2
<b>ELIZ1</b>					277.8		887.8			24.3			134.0	331.0	385.4

\* The December 2000 sample was collected at Station PAS2 while construction activities were underway just upstream; all other samples were collected at Station PAS2a. Omitted because of a very low value due to this construction. Also applicable to Tables 29 – 36.

**Table 29: Total Suspended Sediment PCDD Concentration (pg/g sed)**

	6/20-22/00	12/13-15/00	3/13-15/01	4/12/01	4/25/01	5/15/01	5/24/01	10/17-19/01	10/3/01	11/6/01	3/12-14/02	3/27/02	5/14/02	Mean	Std. Dev.
<b>PAS1</b>	9621	917	10169					5347			9895			7190	4026
<b>PAS2a</b>		*	15406					9198			3398			9334	6005
<b>PAS3</b>		6465	6137					9147			7801			7388	1376
<b>NB1-S</b>	7971	1856	6280					5590			7094			5758	2356
<b>NB1-D</b>	9344	789	4428					6058			5435			5211	3083
<b>NB3</b>		1713	3571					3752			3453			3122	947
<b>AK1-S</b>		2081	6844										10407	6444	4178
<b>AK1-D</b>					10944		6168			8971				8695	2400
<b>PA-S</b>		1604	12701				23585			10869				12189	9017
<b>PA-D</b>					12112		8544			14858				11838	3168
<b>HAC1</b>	6114	283	9289					4820			7918			5685	3468
<b>HAC2</b>		1003	5188					9851			8037			6020	3856
<b>HAC3</b>		871	7518					10544			3436			5592	4288
<b>KVK1</b>		1582	5241					2791			4228			3461	1606
<b>RAR1-S</b>				13372		13488			9001			8186		11012	2813
<b>RAR2</b>				39395		29300			25117			39955		33442	7401
<b>RWY1</b>					15993		9151			9131			22308	14145	6328
<b>ELIZ1</b>					38532		38424			11095			21794	27461	13450

**Table 30: Total Suspended Sediment PCDF Concentrations (pg/L)**

	6/20-22/00	12/13-15/00	3/13-15/01	4/12/01	4/25/01	5/15/01	5/24/01	10/17-19/01	10/3/01	11/6/01	3/12-14/02	3/27/02	5/14/02	Mean	Std. Dev.
<b>PAS1</b>	103.5	11.4	17.2					112.0			23.8			53.6	49.8
<b>PAS2a</b>		*	6.5					75.3			14.0			31.9	37.8
<b>PAS3</b>		1.6	0.6					78.5			23.5			26.0	36.5
<b>NB1-S</b>	38.6	6.5	7.6					35.6			10.6			19.8	15.9
<b>NB1-D</b>	40.5	2.6	7.0					27.5			10.4			17.6	15.9
<b>NB3</b>		3.5	5.9					6.0			3.4			4.7	1.5
<b>AK1-S</b>		4.0	7.1										11.6	7.5	3.8
<b>AK1-D</b>					10.7		4.7			8.3				7.9	3.0
<b>PA-S</b>		1.4	11.7				14.4			4.4				8.0	6.1
<b>PA-D</b>					5.3		8.9			3.9				6.0	2.6
<b>HAC1</b>	87.2	2.7	32.4					50.7			12.9			37.1	33.4
<b>HAC2</b>		8.9	24.8					106.5			20.4			40.2	44.7
<b>HAC3</b>		11.9	41.6					82.3			30.1			41.5	29.8
<b>KVK1</b>		3.1	5.6					8.8			5.2			5.7	2.4
<b>RAR1-S</b>				6.5		3.4			1.6			6.7		4.5	2.5
<b>RAR2</b>				2.5		4.9			6.3			5.2		4.7	1.6
<b>RWY1</b>					15.0		58.2			5.6			105.3	46.0	45.7
<b>ELIZ1</b>					34.0		75.4			4.3			12.0	31.4	31.9

**Table 31: Total Suspended Sediment PCDF Concentrations (pg/g sed)**

	6/20-22/00	12/13-15/00	3/13-15/01	4/12/01	4/25/01	5/15/01	5/24/01	10/17-19/01	10/3/01	11/6/01	3/12-14/02	3/27/02	5/14/02	Mean	Std. Dev.
PAS1	2650	356	1821					1666			2520			1802	914
PAS2a		*	1823					2368			681			1624	861
PAS3		671	349					2040			1324			1096	749
NB1-S	3744	582	1231					1962			2494			2003	1213
NB1-D	3641	156	774					2109			1734			1683	1340
NB3		576	723					640			649			647	60
AK1-S		278	683										1463	808	602
AK1-D					1328			556		1420				1101	475
PA-S		152	939					1475		1045				903	551
PA-D					914			599		1314				942	358
HAC1	4017	95	3560					2351			3579			2721	1592
HAC2		508	2529					5524			4621			3295	2242
HAC3		232	1614					2985			962			1448	1170
KVK1		252	544					594			634			506	173
RAR1-S				446		893			547			445		583	212
RAR2				408		708			514			864		623	203
RWY1					1314		576			1075			1774	1185	499
ELIZ1					4713		3263			1956			1959	2973	1313

**Table 32: Total Suspended Sediment PCDD/F Concentrations (pg/L)**

	6/20-22/00	12/13-15/00	3/13-15/01	4/12/01	4/25/01	5/15/01	5/24/01	10/17-19/01	10/3/01	11/6/01	3/12-14/02	3/27/02	5/14/02	Mean	Std. Dev.
PAS1	478.0	40.8	113.2					471.5			117.4			244.6	213.2
PAS2a		*	61.3					367.9			83.9			171.0	170.9
PAS3		16.6	11.6					430.4			162.0			155.1	196.3
NB1-S	120.6	27.4	46.1					137.2			40.7			74.4	50.6
NB1-D	144.3	15.6	47.2					106.4			43.1			71.3	52.5
NB3		13.8	35.1					41.1			21.2			27.8	12.5
AK1-S		33.6	77.7										94.2	68.5	31.3
AK1-D					98.7		56.6			61.1				72.1	23.1
PA-S		16.0	169.5				244.6			50.7				120.2	105.9
PA-D					75.2		136.5			47.5				86.4	45.5
HAC1	219.9	10.8	116.8					154.5			41.6			108.7	84.6
HAC2		26.5	75.8					296.5			55.9			113.6	123.6
HAC3		56.6	235.6					372.8			137.5			200.6	136.1
KVK1		22.6	59.5					50.3			40.0			43.1	15.8
RAR1-S				200.1		54.7			27.2			130.0		103.0	78.0
RAR2				244.7		209.1			311.6			247.8		253.3	42.6
RWY1					197.6		982.4			53.1			1428.5	665.4	652.3
ELIZ1					311.8		963.2			28.5			146.1	362.4	417.0

**Table 33: Total Suspended Sediment PCDD/F Concentrations (pg/g sed)**

	6/20-22/00	12/13-15/00	3/13-15/01	4/12/01	4/25/01	5/15/01	5/24/01	10/17-19/01	10/3/01	11/6/01	3/12-14/02	3/27/02	5/14/02	Mean	Std. Dev.
<b>PAS1</b>	12267	1273	11990					7014			12415			8983	4872
<b>PAS2a</b>		*	17229					11566			4079			10958	6596
<b>PAS3</b>		7137	6487					11187			9125			8484	2123
<b>NB1-S</b>	11715	2439	7511					7552			9588			7761	3442
<b>NB1-D</b>	12985	945	5202					8167			7169			6894	4389
<b>NB3</b>		2289	4294					4391			4102			3769	994
<b>AK1-S</b>		2358	7528										11870	7252	4762
<b>AK1-D</b>					12273		6724			10392				9796	2822
<b>PA-S</b>		1756	13639				25071			11914				13095	9551
<b>PA-D</b>					13039		9142			16172				12784	3522
<b>HAC1</b>	10131	378	12850					7171			11497			8405	4956
<b>HAC2</b>		1511	7717					15375			12659			9315	6093
<b>HAC3</b>		1103	9132					13529			4398			7041	5438
<b>KVK1</b>		1834	5785					3385			4862			3967	1732
<b>RAR1-S</b>				13818		14381			9548			8631		11594	2926
<b>RAR2</b>				39803		30008			25632			40818		34065	7441
<b>RWY1</b>					17307		9727			10206			24082	15330	6786
<b>ELIZ1</b>					43245		41687			13050			23753	30434	14578

**Table 34: Total Suspended Sediment PCDD/F-OCDD Concentrations (pg/g sed)**

	6/20-22/00	12/13-15/00	3/13-15/01	4/12/01	4/25/01	5/15/01	5/24/01	10/17-19/01	10/3/01	11/6/01	3/12-14/02	3/27/02	5/14/02	Mean	Std. Dev.
<b>PAS1</b>	3921	456	2960					2337			3793			2693	1407
<b>PAS2a</b>		*	3047					3562			1142			1980	1594
<b>PAS3</b>		1343	740					3178			2113			1843	1052
<b>NB1-S</b>	4581	788	1763					2586			3290			2602	1448
<b>NB1-D</b>	4591	235	1187					2781			2340			2227	1655
<b>NB3</b>		753	1040					1038			1020			963	140
<b>AK1-S</b>		436	1337										2442	1405	1005
<b>AK1-D</b>					2172		1019			2207				1799	676
<b>PA-S</b>		258	1654				2849			1846				1652	1067
<b>PA-D</b>					1727		1164			2319				1736	577
<b>HAC1</b>	4674	118	4454					2931			4539			3343	1937
<b>HAC2</b>		599	3016					6433			5348			3849	2594
<b>HAC3</b>		306	2357					4014			1328			2001	1582
<b>KVK1</b>		411	1037					871			1052			843	299
<b>RAR1-S</b>				935		1731			1207			866		1185	393
<b>RAR2</b>				975		1653			1353			2255		1559	540
<b>RWY1</b>					2256		1053			1652			3169	2033	903
<b>ELIZ1</b>					8166		5916			3041			3678	5200	2330

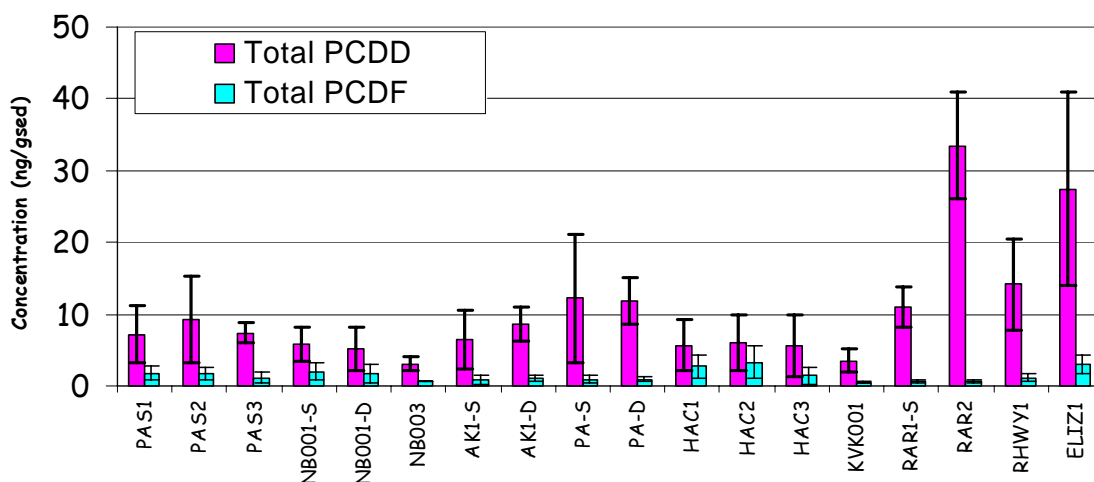


**Table 35: Total Suspended Sediment 2,3,7,8-TCDD Concentrations (pg/g sed)**

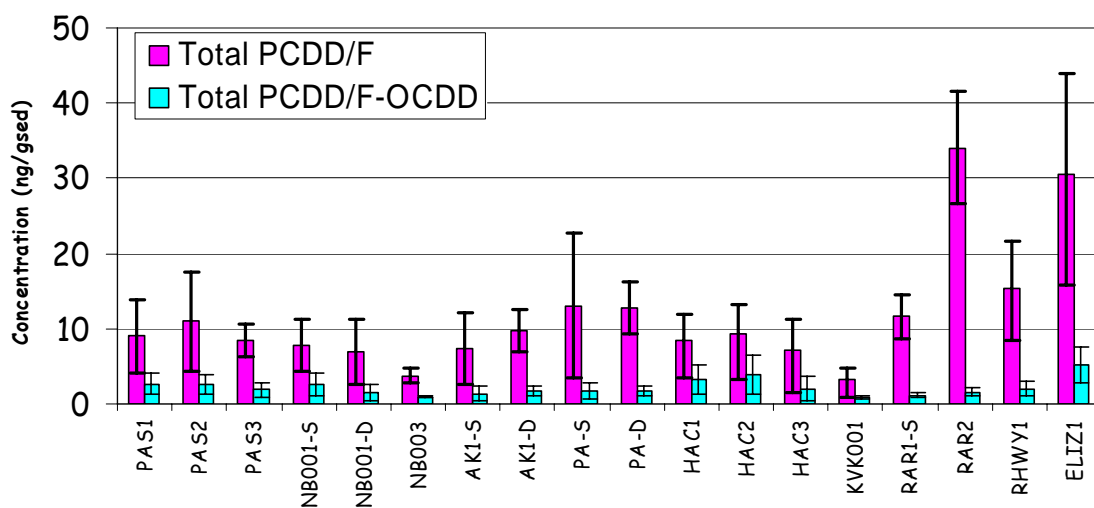
	6/20-22/00	12/13-15/00	3/13-15/01	4/12/01	4/25/01	5/15/01	5/24/01	10/17-19/01	10/3/01	11/6/01	3/12-14/02	3/27/02	5/14/02	Mean	Std. Dev.
PAS1	437.1	24.9	408.9					169.3			353.2			278.7	176.1
PAS2a		*	185.0					443.8			161.0			200.5	179.3
PAS3		19.7	0.0					389.8			154.0			140.9	179.5
NB1-S	202.3	23.4	46.7					116.2			100.8			97.9	69.7
NB1-D	209.8	5.8	33.7					96.4			71.0			83.4	78.8
NB3		17.8	25.6					25.7			24.8			23.4	3.8
AK1-S		12.2	26.5										59.8	32.9	24.4
AK1-D					42.9		14.9			39.3				32.4	15.3
PA-S		2.7	28.0				22.2			0.0				13.2	13.9
PA-D					38.9		9.5			0.0				16.1	20.3
HAC1	149.8	2.5	109.1					133.7			174.4			113.9	66.7
HAC2		14.0	62.1					139.2			91.5			76.7	52.5
HAC3		5.8	41.3					72.2			21.4			35.2	28.7
KVK1		11.4	33.0					15.2			24.5			21.0	9.7
RAR1-S				6.0		19.7			13.4			8.7		12.0	6.0
RAR2				0.0		6.5			0.0			6.9		3.3	3.9
RWY1					26.2		7.2			15.3			21.6	17.6	8.2
ELIZ1					146.7		9.7			61.9			44.9	65.8	58.1

**Table 36: Total Suspended Sediment 2,3,7,8-TCDD Concentrations (pg/L)**

	6/20-22/00	12/13-15/00	3/13-15/01	4/12/01	4/25/01	5/15/01	5/24/01	10/17-19/01	10/3/01	11/6/01	3/12-14/02	3/27/02	5/14/02	Mean	Std. Dev.
PAS1	17.1	0.8	3.9					11.4			3.3			7.3	6.7
PAS2a		*	0.7					14.1			3.3			4.7	6.4
PAS3		0.0	0.0					15.0			2.7			4.4	7.1
NB1-S	2.1	0.3	0.3					2.1			0.4			1.1	0.9
NB1-D	2.3	0.1	0.3					1.3			0.4			0.9	0.9
NB3		0.1	0.2					0.2			0.1			0.2	0.1
AK1-S		0.2	0.3										0.5	0.3	0.2
AK1-D					0.4		0.1			0.2				0.2	0.1
PA-S		0.0	0.4				0.2			0.0				0.2	0.2
PA-D					0.2		0.1			0.0				0.1	0.1
HAC1	3.3	0.1	1.0					2.9			0.6			1.6	1.4
HAC2		0.3	0.6					2.7			0.4			1.0	1.1
HAC3		0.3	1.1					2.0			0.7			1.0	0.7
KVK1		0.1	0.3					0.2			0.2			0.2	0.1
RAR1-S				0.1		0.1			0.0			0.1		0.1	0.0
RAR2				0.0		0.1			0.0			0.0		0.0	0.0
RWY1					0.3		0.7			0.1			1.3	0.6	0.5
ELIZ1					1.1		0.2			0.1			0.3	0.4	0.4



**Figure 48:** Mean ( $\pm$  one standard deviation) concentration tPCDDs and tPCDFs in the suspended sediment phase (ng/g sed) at every sampling station.



**Figure 49:** Mean concentration ( $\pm$  one standard deviation) of total PCDD/Fs with and without OCDD (tPCDD/F – OCDD) in the suspended sediment phase at every sampling station.

#### 5.5.4 PCDD/F Toxicity

The toxicity equivalency quotient (TEQ) of a sample resulting from PCDD/Fs and dioxin-like coplanar PCBs (relative to 2,3,7,8-TCDD) can be estimated using their associated Toxic Equivalency Factors (TEFs) – see the following table. The toxicity (TEQ) for each congener is calculated by multiplying its concentration by its TEF. These individual compound-specific TEQs are then summed to calculate the sample total TEQ.

#### **Dioxins/furans and Co-planar PCB congeners, and their Associated Toxic Equivalency Factors (TEFs).**

<u>Dioxins/furans:</u>	<u>Congener-PCDDs:</u>	<u>TEFs-Proposed <sup>(1)</sup></u>
	2,3,7,8-TCDD	1
	1,2,3,7,8-PeCDD	1
	1,2,3,4,7,8-HxCDD	0.1
	1,2,3,7,8,9-HxCDD	0.1
	1,2,3,6,7,8-HxCDD	0.1
	1,2,3,4,6,7,8-HpCDD	0.01
	1,2,3,4,6,7,8,9,-OCDD	0.0001
	<u>Congener-PCDFs:</u>	
	2,3,7,8-TCDF	0.1
	1,2,3,7,8-PeCDF	0.05
	2,3,4,7,8,-PeCDF	0.5
	1,2,3,4,7,8-HxCDF	0.1
	1,2,3,7,8,9-HxCDF	0.1
	1,2,3,6,7,8-HxCDF	0.1
	2,3,4,6,7,8-HxCDF	0.1
	1,2,3,4,6,7,8-HpCDF	0.01
	1,2,3,4,7,8,9-HpCDF	0.01
	1,2,3,4,6,7,8,9,-OCDF	0.0001
	<u>Dioxin-Like PCBs (IUPAC #):</u>	
	77	0.0001
	81	0.0001
	105	0.0001
	114	0.0005
	118	0.0001
	123	0.0001
	126	0.1
	156	0.0005
	157	0.0005
	167	0.00001
	169	0.01
	189	0.0001

<sup>(1)</sup> World Health Organization (WHO): van Leeuwen, FXR. 1997. Derivation of toxic equivalency factors (TEFs) for dioxin-like compounds in humans and wildlife. *Organohalogen Compounds* 34: 237; and van den Berg, M., Birnbaum, L., Bosveld, ATC. et al., 1998. Toxic equivalency factors (TEFs) for PCBs, PCDDs, PCDFs for humans and wildlife. *Environ. Health. Perspect.* 106(12): 775-792.

Tables 37 through 39 show the TEQ due to tPCDD, tPCDF, and tPCDD/F (in pg TEF/g sed) at all sampling stations during all sampling events, as well as the overall arithmetic mean and standard deviation of this data. Averaged over all sampling stations, approximately 65% of the tPCDD/F TEQ comes from tPCDDs and 35% from tPCDFs. Those congeners contributing the most to this “average TEQ” are 2,3,7,8-TCDD (~44%), 2,3,4,7,8-PeCDF (~11%), and 1,2,3,7,8-PeCDD, 1,2,3,4,6,7,8-HpCDD, and 1,2,3,4,7,8-HxCDF (7-8% each).

As seen in Figure 50, the highest toxicities (TEQ) were measured in the Passaic River (mean = 179 to 343 pg TEF/g sed) and were largely due to high 2,3,7,8-TCDD concentrations (mean = 141 to 279 pg/g sed; see Table 35) that accounted for, on average, 68-79% of the TEQ in these samples. Total TEQ levels were also elevated in upper Newark Bay (Stations NB1-S/D means = 142 to 178 pg TEF/g sed) and the mid/lower Hackensack River (Stations HAC1 mean = 199 pg TEF/g sed and HAC2 mean = 167 pg TEF/g sed). The higher tPCDD/F TEQs at these stations were due to a combination of higher 2,3,7,8-TCDD concentrations (means = 77 to 114 pg/g sed, see Table 35; 47-60% of the TEQ) and elevated concentrations of 2,3,4,7,8-PeCDF and 1,2,3,4,7,8-HxCDF (8-17% of the TEQ).

Total TEQ was also high in the Elizabeth River (mean = 210 pg TEF/g sed) as a result of very high total PCDD/F concentrations (mean = 30.4 ng/g sed; see Table 33). On average, 2,3,7,8-TCDD accounted for 28% of the tPCDD/F TEQ, with 2,3,4,7,8-PeCDF, 1,2,3,7,8-PeCDD, and 1,2,3,4,6,7,8-HpCDD each accounting for 10-12% of the TEQ.

Mean tPCDD/F TEQ were less than 90 pg TEF/g sed at the remaining stations, with the lowest mean levels (~50 pg TEF/g sed or less) in lower Newark Bay, the Kill van Kull, and the Raritan River. The Raritan River samples differed from the other areas of the harbor, with 2,3,7,8-TCDD accounting for only a small percentage of the tPCDD/F TEQ (mean Station RAR1-S = 20% and Station RAR2 = 7%).

In general, variability in tPCDD TEQ (as reflected in the coefficient of variation) was equal to or slightly greater than that in the tPCDD concentrations (pg/g sed, see Table 29). A notable exception is Station PAS3, where the tPCDD TEQ variability (1.20) was much greater than the tPCDD pg/g sed variability (0.186). The variability in tPCDD TEQ at this station is due to consistently varying TEQ concentrations, with very high levels during dry weather events (October 2001 and March 2002), and low levels during wet weather events (December 2000 and March 2001). During the dry weather events, 2,3,7,8-TCDD accounted for 76-85% of the tPCDD/F TEQ; in contrast, during the wet weather events, it was not detected (March 2001) or accounted for only 42% of the tPCDD/F TEQ.

In general, variability in tPCDF TEQ (as reflected in the coefficient of variation) was equal to that in the tPCDF concentrations (pg/g sed, see Table 31).

Likewise, variability in tPCDD/F TEQ (as reflected in the coefficient of variation) was equal to that in the tPCDD/F concentrations (pg/g sed, see Table 33). However, the TEQ variability was much greater at Station PAS3 (discussed above), and moderately greater (~20%) at the upper Newark Bay and Raritan River stations.

Over all sampling stations, there was no correlation ( $r = 0.015$ ) between tPCDD/F TEQ (pg TEF/g sed) and SS (mg/L).

**Table 37:** Total Toxicity (TEQ) from PCDDs (pg TEF/g sed)

	6/20- 22/00	12/13- 15/00	3/13- 15/01	4/12/01	4/25/01	5/15/01	5/24/01	10/17- 19/01	10/3/01	11/6/01	3/12- 14/02	3/27/02	5/14/02	Mean	Std. Dev.
<b>PAS1</b>	459.6	27.2	432.8					184.3			380.2			296.8	184.3
<b>PAS2a</b>		*	223.8					467.1			171.1			287.4	157.9
<b>PAS3</b>		35.1	4.5					412.7			167.5			155.0	185.9
<b>NB1-S</b>	222.1	28.1	62.9					132.8			127.0			114.6	74.5
<b>NB1-D</b>	233.3	7.8	45.8					113.0			89.3			97.8	85.8
<b>NB3</b>		22.7	34.9					37.4			37.1			33.0	7.0
<b>AK1-S</b>		16.4	43.5										86.2	48.7	35.2
<b>AK1-D</b>					70.2		30.0			60.9				53.7	21.0
<b>PA-S</b>		6.4	52.6				65.9			28.1				38.2	26.4
<b>PA-D</b>					56.2		28.2			21.8				35.4	18.3
<b>HAC1</b>	165.9	3.1	135.8					150.2			191.4			129.3	73.5
<b>HAC2</b>		16.3	76.1					164.2			104.3			90.3	61.5
<b>HAC3</b>		7.6	59.9					99.6			27.9			48.7	40.2
<b>KVK1</b>		15.6	46.6					24.3			32.3			29.7	13.2
<b>RAR1-S</b>				23.8		48.6			37.3			22.9		33.1	12.2
<b>RAR2</b>				9.6		34.8			32.9			45.2		30.6	15.0
<b>RWY1</b>					54.5		22.1			35.4			60.2	43.0	17.5
<b>ELIZ1</b>					250.1		83.0			100.0			91.6	131.1	79.6

\* The December 2000 sample was collected at Station PAS2 while construction activities were underway just upstream; all other samples were collected at Station PAS2a. Omitted because of a very low value due to this construction.

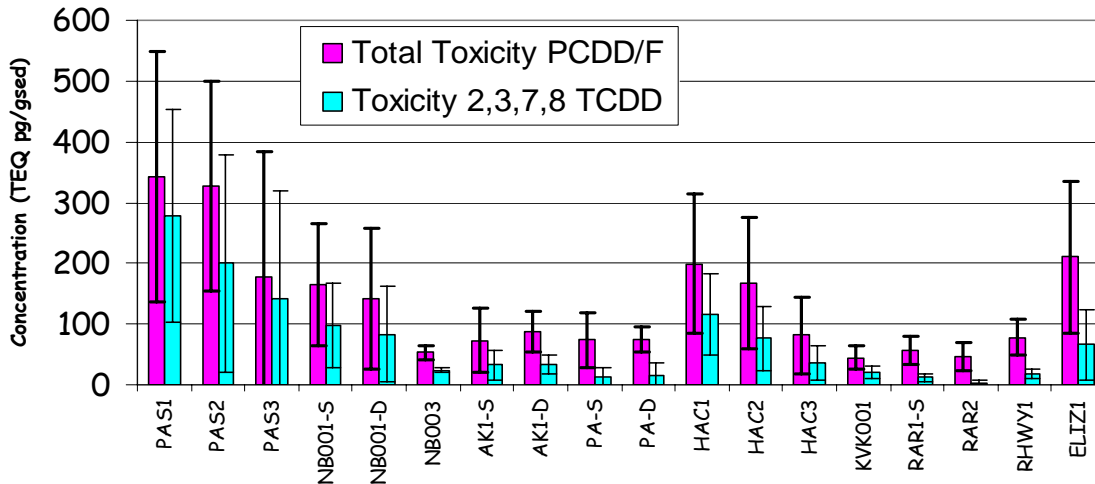
**Table 38: Total Toxicity (TEQ) from PCDFs (pg TEF/g sed)**

	6/20-22/00	12/13-15/00	3/13-15/01	4/12/01	4/25/01	5/15/01	5/24/01	10/17-19/01	10/3/01	11/6/01	3/12-14/02	3/27/02	5/14/02	Mean	Std. Dev.
<b>PAS1</b>	60.7	7.7	48.3					40.9			76.5			46.8	25.7
<b>PAS2a</b>		*	45.5					53.5			18.7			39.2	18.2
<b>PAS3</b>		11.9	3.5					46.3			34.3			24.0	19.7
<b>NB1-S</b>	77.5	12.4	33.1					46.5			81.7			50.2	29.5
<b>NB1-D</b>	87.6	3.9	27.1					51.0			49.2			43.8	31.1
<b>NB3</b>		14.7	21.9					19.3			24.1			20.0	4.0
<b>AK1-S</b>		7.1	23.3										41.6	24.0	17.2
<b>AK1-D</b>					43.0		20.2			38.5				33.9	12.1
<b>PA-S</b>		5.5	42.1				52.4			40.9				35.2	20.5
<b>PA-D</b>					39.6		26.7			48.1				38.1	10.8
<b>HAC1</b>	84.9	2.2	97.4					52.4			104.5			68.3	42.0
<b>HAC2</b>		10.4	66.9					113.0			118.5			77.2	50.2
<b>HAC3</b>		5.2	41.2					60.9			23.6			32.7	23.9
<b>KVK1</b>		7.1	17.6					12.7			23.6			15.2	7.0
<b>RAR1-S</b>				16.4		38.9			23.5			17.0		24.0	10.5
<b>RAR2</b>				5.0		23.3			15.8			20.7		16.2	8.1
<b>RWY1</b>					43.1		18.3			33.1			44.4	34.7	12.0
<b>ELIZ1</b>					147.7		55.0			56.0			56.9	78.9	45.9

**Table 39: Total Toxicity (TEQ) from PCDD/Fs (pg TEF/g sed)**

	6/20-22/00	12/13-15/00	3/13-15/01	4/12/01	4/25/01	5/15/01	5/24/01	10/17-19/01	10/3/01	11/6/01	3/12-14/02	3/27/02	5/14/02	Mean	Std. Dev.
<b>PAS1</b>	520.3	34.9	481.1					225.2			456.7			343.6	207.5
<b>PAS2a</b>		*	269.2					520.7			189.9			326.6	172.7
<b>PAS3</b>		47.0	8.0					459.0			201.8			179.0	204.6
<b>NB1-S</b>	299.6	40.5	96.0					179.3			208.7			164.8	100.6
<b>NB1-D</b>	320.9	11.7	72.9					163.9			138.5			141.6	116.5
<b>NB3</b>		37.5	56.8					56.7			61.2			53.0	10.6
<b>AK1-S</b>		23.5	66.7										127.8	72.7	52.4
<b>AK1-D</b>					113.2		50.2			99.4				87.6	33.1
<b>PA-S</b>		11.9	94.7				118.3			69.0				73.5	45.7
<b>PA-D</b>					95.8		55.0			69.9				73.5	20.6
<b>HAC1</b>	251.0	5.2	233.1					202.6			295.9			197.6	112.7
<b>HAC2</b>		26.7	143.1					277.2			222.8			167.4	108.8
<b>HAC3</b>		12.8	101.0					160.5			51.5			81.5	63.9
<b>KVK1</b>		22.7	64.1					37.0			55.9			44.9	18.7
<b>RAR1-S</b>				40.2		87.5			60.8			39.9		57.1	22.5
<b>RAR2</b>				14.5		58.2			48.8			65.9		46.8	22.6
<b>RWY1</b>					97.6		40.4			68.5			104.7	77.8	29.4
<b>ELIZ1</b>					397.7		137.9			156.0			148.4	210.0	125.4

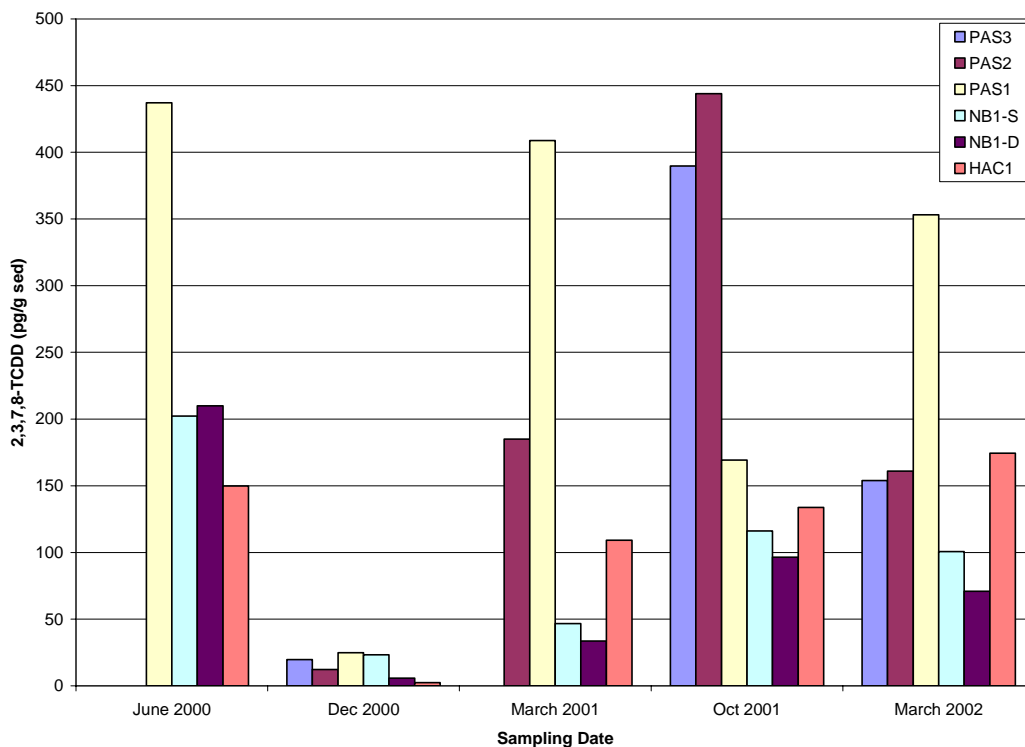
\* The December 2000 sample was collected at Station PAS2 while construction activities were underway just upstream; all other samples were collected at Station PAS2a. Omitted because of a very low value due to this construction.



**Figure 50:** Mean  $\pm$  one standard deviation of total PCDD/Fs and 2,3,7,8 TCDD toxicity (TEQ; pg TEF/g sed) at every sampling station.

One of the most toxic of the PCDD/F congeners is 2,3,7,8-TCDD (TEF = 1). Over all sampling stations, ~44% of the tPCDD/F TEQ was the result of 2,3,7,8-TCDD, with a range among the sampling stations of 7% to 79%. The highest concentrations of 2,3,7,8-TCDD (as well as %TEQ resulting from 2,3,7,8-TCDD) were found in the Passaic and Hackensack Rivers, and upper Newark Bay.

Figure 51 presents the 2,3,7,8-TCDD concentrations (pg/g sed) along the Passaic River, upper Newark Bay (Stations NB1-S/D), and in the lower Hackensack River (Station HAC1) during all sampling events. 2,3,7,8-TCDD concentrations were variable at each of these stations, with coefficients of variation ranging from 0.59 to 0.95, except for Station PAS3, with a coefficient of variation of 1.27 (discussed above). The highest concentrations were consistently found at the lower Passaic River Station PAS1; except during the October 2001 sampling survey, where the highest concentrations were at the upstream PAS2 and PAS3 stations. There did not appear to be any consistent dry-wet weather pattern in the 2,3,7,8-TCDD concentrations at these stations, except for Station PAS3 (discussed above). The 2,3,7,8-TCDD concentration distribution pattern among these sites points to the existence of a source(s) along the Passaic River, most probably between sampling stations PAS1 and PAS2. The major source of this 2,3,7,8-TCDD has been attributed to the Diamond Alkali (Lister Avenue, Newark) site located on the banks of the lower Passaic River.



**Figure 51:** 2,3,7,8-TCDD concentrations (pg/g sed) at selected sampling stations.

Mean TEQ due to co-planar PCBs (data not shown) was highest in the Elizabeth River (54 pg TEF/g sed), elevated at Stations PAS1, NB1-S, and PA-S/D (20 to 25 pg TEF/g sed), and less than 17 pg TEF/g sed at the remaining stations. Except in a few samples where it was not detected, PCB126 (TEF = 0.1) accounted for 54-85% of the co-planar PCB TEQ. The mean percent Total PCDD/F + PCB TEQ due to coplanar PCBs was elevated (>20%) at Stations ELIZ1, NB3, PA-S and PA-D; in contrast, the percentage was particularly low (< 1%) at the Hackensack and Raritan River stations. The mean percent Total PCDD/F + PCB TEQ due to coplanar PCBs ranged between 7 and 18% at the remaining stations.

### 5.5.5 PCDD/F Source Identification Based on Congener Distribution Patterns

In general, major sources of PCDD/Fs to the environment include the following (Hagenmaier et al., 1994):

- thermal processes in the presence of a chlorine source, such as combustion and metallurgic processes,
- industrial processes which are based on chlorine chemistry, and
- biochemical transformations of precursors such as PCBs.



Sediment contamination in industrialized waterways (such as NY-NJ Harbor) is usually due to permitted municipal and industrial wastewater discharges, stormwater runoff, and atmospheric deposition (Huntley et al, 1998). The PCDD/F congener distribution patterns associated with these types of sources vary.

Figure 52 shows the mean PCDD/F congener distribution pattern at each of the sampling stations. The furan distribution pattern is more variable among the sites than the dioxin distribution pattern (except for 2,3,7,8-TCDD). Thus, for source identification purposes, 2,3,7,8-TCDD and the furans will be most useful.

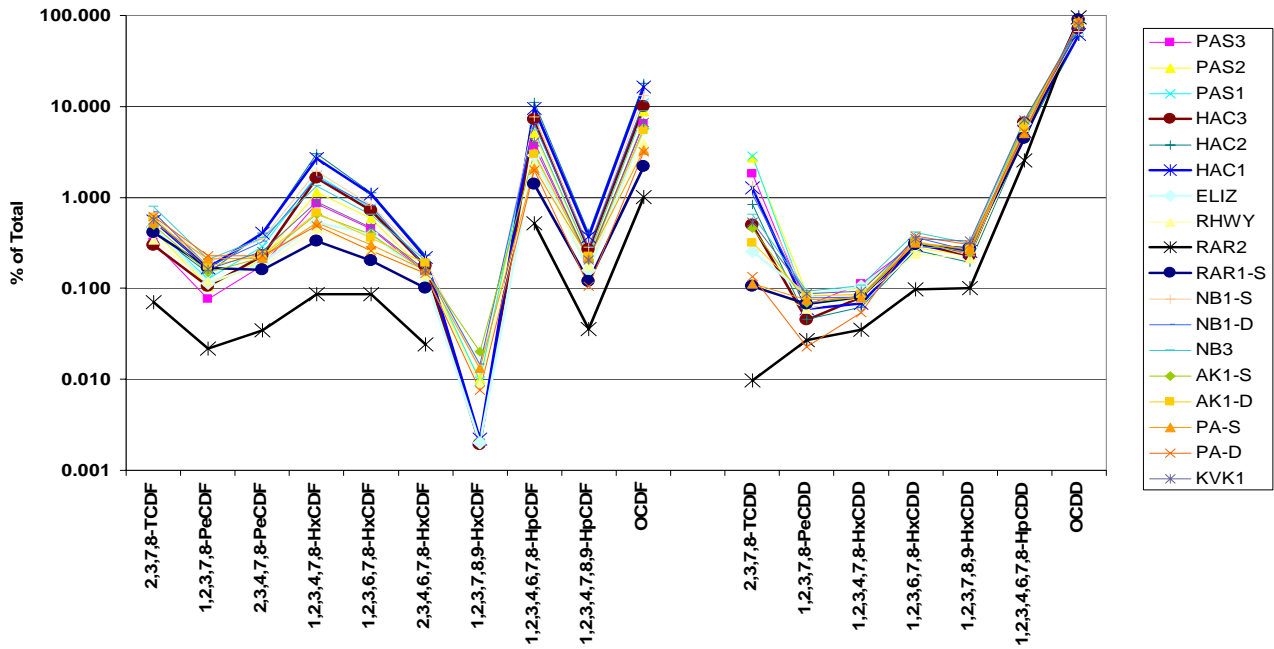
The OCDD congener dominates all stations (69 - 95% of the mean total PCDD/F concentration at each station) but there is no consistent background OCDD concentration (mean = 9,122 ± 8,707 pg/g sed).

Raritan River sampling station RAR2 has a different mean PCDD/F distribution pattern than all of the other stations. It shows a high percentage of OCDD - over 95% of the mean total PCDD/F concentration - and lower percentages of the remaining congeners compared to the other stations; this is indicative of a sewage sludge source for PCDD/Fs (Huntley et al, 1998; Cleverly et al, 1997).

Compared to the other stations, the mid/lower Hackensack River sampling stations (HAC1 and HAC2) show a higher mean percentage of tPCDF (31-35% of the total PCDD/F concentration). This is primarily due to higher mean percentages of OCDF (16-18%), 1,2,3,4,6,7,8-HpCDF (10-11%), and 1,2,3,4,7,8-HxCDF (3%). A similar, but not as "strong", mean pattern in these furan congeners (21-25% tPCDF) was found at Stations HAC3, NB1-S/D, and PAS1. This may be indicative of a dioxin/furan source along the lower Hackensack River.

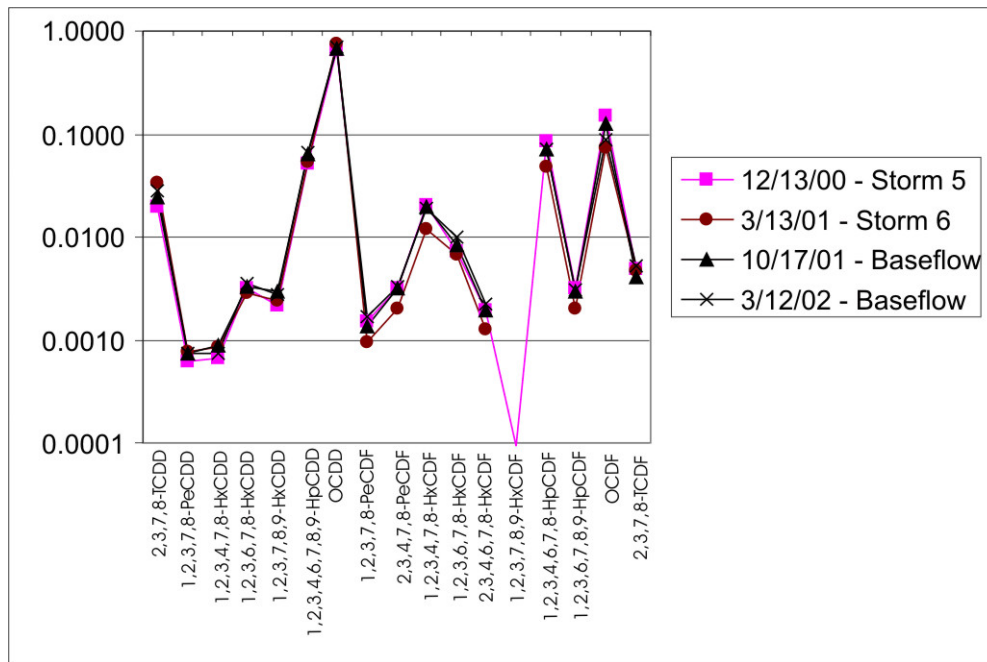
As examples, Figure 53ab shows the PCDD/F congener distribution patterns of all of the samples collected at Stations PAS1 and ELIZ. The highest 2,3,7,8-TCDD concentrations in NY-NJ Harbor were observed at Station PAS1, and there is very little variability in the PCDD/F congener distribution patterns for each sampling event at this station (Figure 53a). This is indicative of a single source of dioxins/furans. In contrast, the PCDD/F distribution patterns are more variable among the sampling events at Station ELIZ (Figure 53b). The lower chlorinated PCDD/Fs (tetra through hexa, including 2,3,7,8-TCDD) comprise a higher percentage of the tPCDD/Fs during the dry weather surveys (April and November 2001) compared with the wet weather surveys (May 2001 and May 2002). This indicates two different sources of PCDD/Fs to the lower Elizabeth River.

As another example, in Figure 54 the congener distribution patterns of incinerator soil and sewage sludge (Huntley et al, 1998) are compared to those of selected samples from Passaic River Stations PAS1 and PAS2, and the Elizabeth River Station ELIZ (these stations had the highest tPCDD/F TEQ toxicities). The congener distribution patterns of the two Passaic Stations are similar. All three stations had congener distribution patterns that lie between those of the incinerator soil and the sewage sludge, except for the 2,3,7,8-TCDD congener in the Passaic River samples.

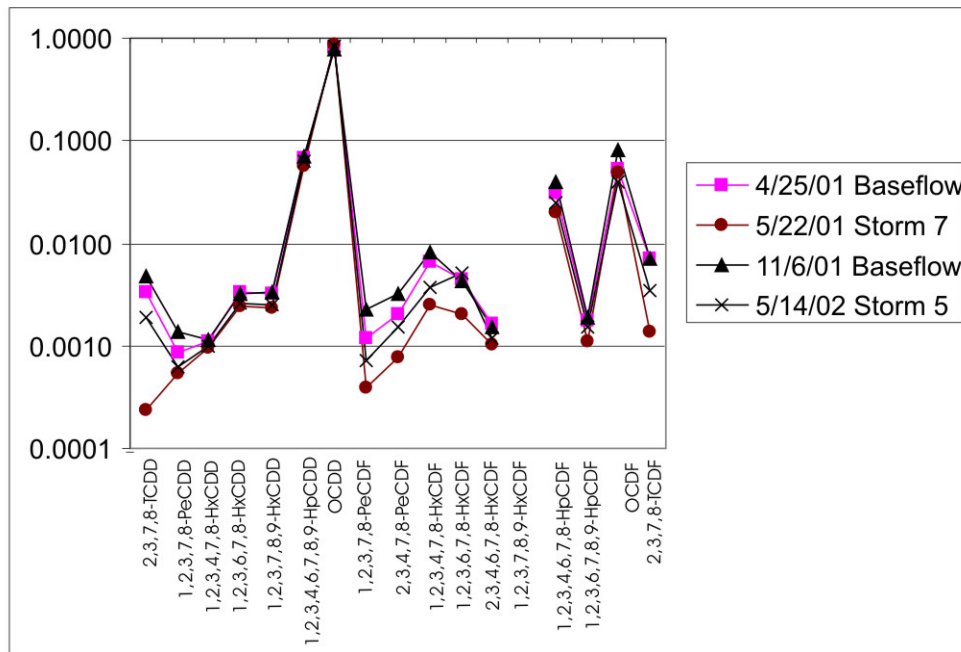


**Figure 52:** Mean PCDD/F congener distribution at each NJTRWP sampling station.

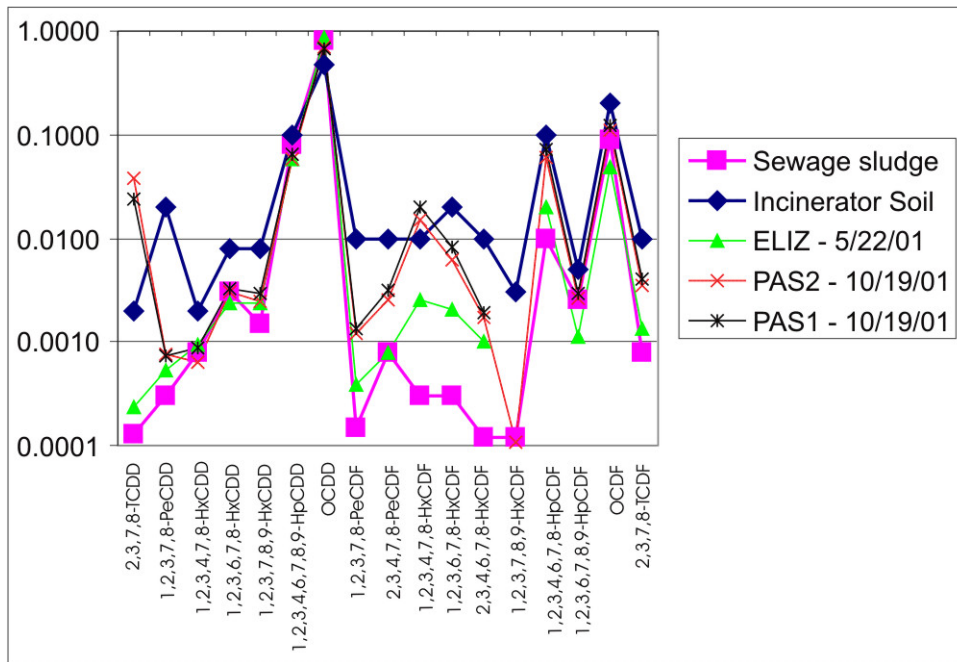
(a)



(b)



**Figure 53:** PCDD/F congener distribution patterns at selected sampling stations for all sampling events: (a) PAS1, and (b) ELIZ



**Figure 54:** PCDD/F congener distribution pattern for sewage sludge, incinerator soil, and at sampling stations PAS1, PAS2, and ELIZ for selected dates.

### 5.5.6 Dioxins/Furans - Conclusions

- (1) The highest concentrations of 2,3,7,8-TCDD (as well as %TEQ resulting from 2,3,7,8-TCDD) were found in the Passaic and Hackensack Rivers, and in upper Newark Bay.
- (2) Total PCDD/F concentrations were largely determined by the tPCDD concentrations. In addition, there was a moderate correlation between Total Suspended Sediment PCDD/F (pg/L) and SS ( $r = 0.65$ ), but there was no correlation ( $r = -0.09$ ) between Total Suspended Sediment PCDD/Fs (pg/g sed) and SS (mg/L). Overall, approximately 77% of the Total PCDD/F was OCDD.
- (3) Based on tPCDD/F and 2,3,7,8-TCDD concentrations, and tPCDD/F TEQs, it appears that the harbor estuary can be separated into 5 sub-areas, as follows:
  - Passaic River, Upper Newark Bay, and the Hackensack River: characterized by elevated levels of 2,3,7,8-TCDD (particularly in the lower Passaic River) with mean concentrations exceeding 1 pg/L and 65 pg/g sed. The high 2,3,7,8-TCDD concentrations at these stations also resulted in high tPCDD/F TEQs (>140 pg TEF/g sed).
  - Elizabeth River: characterized by elevated levels of tPCDD/Fs, with mean concentrations exceeding 360 pg/L and 30 ng/g sed, together with elevated mean

levels of 2,3,7,8-TCDD (66 pg/g sed and 0.42 pg/L). The high tPCDD/F and 2,3,7,8-TCDD concentrations resulted in a high mean tPCDD/F TEQ (210 pg TEF/g sed).

- Rahway River: characterized by very high levels of tPCDD/Fs and elevated levels of 2,3,7,8-TCDD, with mean concentrations of 665 pg/L and 60 pg/L, respectively. However, levels of SS-normalized tPCDD/Fs (mean = 15.3 ng/g sed) and 2,3,7,8-TCDD (mean = 17.6 pg/g sed) are only moderately high. As a result, the mean tPCDD/F TEQ (78 pg TEF/g sed) is not elevated.
  - Raritan River: the upper Raritan River is characterized by elevated levels of tPCDD/Fs (mean = 252 pg/L and 34.1 ng/g sed) due to very high concentrations of OCDD (95% of the tPCDD/Fs). PCDD/F concentrations in the lower Raritan River (mean = 103 pg/L and 11.6 ng/g sed) are similar to those in the lower Arthur Kill. 2,3,7,8-TCDD concentrations are low. Total PCDD/F TEQ at both sites were among the lowest in the harbor.
  - Arthur Kill, Kill Van Kull, and Lower Newark Bay: characterized by low to moderate mean levels of tPCDD/Fs (<13 pg/g sed and <120 pg/L) and low mean levels of 2,3,7,8-TCDD (< 33 pg g sed and <0.3 pg/L). Total PCDD/F TEQ are low at these sites.
- (4) The mean furan congener distribution pattern is more variable among the sites than the mean dioxin congener distribution pattern (except for 2,3,7,8-TCDD). Thus, for source identification purposes, 2,3,7,8-TCDD and the furans will be most useful.
- (5) Analysis of the PCDD/F congener distribution patterns have identified potential sources of PCDD/Fs to NY-NJ Harbor associated with the following locations:
- Lower Passaic River (and upper Newark Bay and lower Hackensack River): 2,3,7,8-TCDD.
  - Lower Hackensack River: PCDFs, particularly OCDF, 1,2,3,4,6,7,8-HpCDF, and 1,2,3,4,7,8-HxCDF.
  - Elizabeth River (2 different sources): tetra- through hexa- PCDD/Fs, including 2,3,7,8-TCDD.
  - Upper Raritan River: OCDD.
- (6) The New Jersey Saline Human Health Water Quality Criteria (WQC) for 2,3,7,8-TCDD (0.0051 pg/L) was exceeded by all samples collected in this study (except for a few samples where 2,3,7,8-TCDD was not detected.)

## 5.6 PAHs

### 5.6.1 Sample Analysis

A modified version of California Air Resources Board (CARB) Method 429 was used to measure the dissolved and particulate phase (suspended sediment) concentrations of 24 individual PAH compounds (see Table 1) and total C2 and C3 alkylnaphthalenes. This method used high-resolution gas chromatography and low-resolution selected ion monitoring mass spectrometry (HRGC/LRMS-SIM) with isotope dilution to analyze the TOPS filter samples (particulate phase) and filtered grab samples (dissolved phase).

The detection limit achieved for each PAH target analyte varied among the samples, due to analytical differences as well as differences in sample size. In addition, during the course of sampling, revisions/improvements were made to the PAH analytical method that resulted in a lowering of the analytical detection limits. Thus, the PAH samples can be separated into two groups: Group 1 – December 2000 through May 2001 surveys, Group 2 – October 2001 through May 2002 surveys.

Considering all PAHs (except the total C2 and C3 alkylnaphthalenes), the mean detection limit was the same for all of the Group 1 dissolved PAH samples - 3.1 ng/L (n = 37). For the Group 2 dissolved PAH samples (n = 32), the mean detection limit ranged between 0.143 and 0.533 ng/L, with a mean  $\pm$  standard deviation of  $0.282 \pm 0.100$  ng/L. The mean detection limit for the Group 1 suspended sediment phase (TOPS filter) samples (n = 37), ranged between 0.0053 and 0.1659 ng/L, with a mean  $\pm$  standard deviation of  $0.0246 \pm 0.0349$  ng/L; and between 0.20 and 22.05 ng/g sed, with a mean  $\pm$  standard deviation of  $1.99 \pm 3.78$  ng/g sed. The mean detection limit for the Group 2 suspended sediment phase (TOPS filter) samples (n = 30), ranged between 0.0010 and 0.2027 ng/L, with a mean  $\pm$  standard deviation of  $0.0193 \pm 0.0369$  ng/L; and between 0.109 and 4.419 ng/g sed, with a mean  $\pm$  standard deviation of  $1.301 \pm 1.257$  ng/g sed.

### 5.6.2 Blank Correction

The sample data was subjected to a preliminary Quality Assurance Verification Review. In addition, because of the nature of the samples and the trace concentrations expected for the target analytes, a “maximum blank” approach was developed to assess the impact of background contamination on the usability of the sample data. For each survey, one (1) dissolved fraction grab sample Equipment Blank was prepared in the laboratory by pumping one (1) or two (2) liters of water supplied by the analytical laboratory through a TOPS after it had been cleaned and prepared for sampling. One (1) TOPS Filter and one (1) dissolved fraction grab sample Field Blank were collected at each sampling location. The TOPS Filter Field Blank was collected by exposing a set of TOPS filters to the surrounding air while the TOPS filters that were used for sampling were installed and removed from the sampling equipment. Likewise, for the dissolved fraction grab sample Field Blank, a bottle of water supplied by the analytical laboratory was

exposed to the surrounding air (by removing its cap) while the field sample was collected. The TOPS Filter Field Blank from one of the sites in each survey was analyzed in the same manner as its associated samples; the remaining TOPS Filter Field Blanks were archived. All of the dissolved fraction grab sample Field Blanks were analyzed. At least one (1) laboratory Method Blank was also prepared and analyzed by the analytical laboratory for each Sample Delivery Group (SDG). That blank having the largest value (the “maximum blank”) was used to assess the effect of background contamination on the sample data for that survey (see Section 4.3). In order for a sample result to be usable, it must have been at least five times (5X) greater than the “maximum blank”. No other blank correction was performed on the sample data.

Table 40 shows the mean Dissolved PAH Field, Method, and Equipment Blank data from a total of 10 Group 1 surveys completed from December 2000 through May 2001. There were a total of 37 Field Blanks, 9 Method Blanks, and 4 Equipment Blanks in the Group 1 samples. Table 41 shows the mean Dissolved PAH Field, Method, and Equipment Blank data from a total of 10 Group 2 surveys completed from October 2001 through May 2002. There were a total of 32 Field Blanks, 8 Method Blanks, and 5 Equipment Blanks in the Group 2 samples. The "Maximum Mean Blank" for each analyte is highlighted in gray in the tables, and values of “0.00” were non-detects (detection limits were discussed in Section 5.6.1).

The following conclusions can be drawn:

- For the Group 1 samples, only 4 PAH compounds were consistently found in all of the Group 1 Blanks: naphthalene, 2-methylnaphthalene, and the C2 and C3 alkyl naphthalenes; 1-methylnaphthalene and 2,6 di-methylnaphthalene were found in 3 of the 4 Equipment Blanks. Thus, it can be expected that most of the Group 1 samples have the potential to be potentially impacted by blank contamination impacts for these 6 analytes. Blank contamination impacts on the remaining PAH analytes should be limited to sample or survey-specific situations.

Focusing only on the 6 PAH analytes noted above, the following analytes were impacted by blank contamination for the stated number of dissolved grab samples (n = 37):

- 2-methylnaphthalene = 37
- naphthalene = 26
- 1-methylnaphthalene = 26
- C2 alkyl naphthalenes = 20
- 2,6-dimethylnaphthalene = 18
- C3 alkyl naphthalenes = 6

- In contrast, for the Group 2 samples, only 5 PAH compounds were not consistently found in all of the Group 2 Blanks: 2,3,5-trimethylnaphthalene, anthracene, benzo(k)fluoranthene, benzo(a)pyrene, and perylene. Blank contamination impacts on these 5 PAH analytes should be limited to sample or survey-specific situations. However, it can be expected that most of the Group 2 samples have the potential to be impacted by blank contamination for the remaining analytes. The following analytes were consistently

impacted by blank contamination in the 32 Group 2 samples, with the number of samples impacted listed in parentheses:

- 2-methylnaphthalene (32)
- naphthalene (32)
- 1-methylnaphthalene (32)
- biphenyl (30)
- 2,6-dimethylnaphthalene (27)
- C2 alkyl naphthalenes (26)
- fluorene (24)
- acenaphthylene (24)
- C3 alkyl naphthalenes (19)
- dibenz(a,h)anthracene (16)

For a more detailed analysis of blank contamination impacts on the dissolved grab sample PAH data, see the report “NJTRWP SIT Water Grab Sample PAH Blanks (Draft – September 10, 2003)” in Appendix E.

Minimal Blank contamination impacts were found for the TOPS Filter (suspended sediment fraction) samples. In a total of 68 samples, blank contamination impacts were found in more than one (1) sample for only the following analytes (with the number of samples impacted listed in parentheses):

- acenaphthene (7)
- naphthalene (6)
- 1-methylphenanthrene (4)
- 1-methylnaphthalene (2).



**Table 40:** Mean Group 1 Field, Method, and Equipment Blank Dissolved PAH Data

SIT Grab Samples Group 1	Group 1 Mean FB	Group 1 FB Std Dev	Group 1 Mean MB	Group 1 MB Std Dev	Group 1 Mean EB	Group 1 EB Std Dev
<b>Units: ng/L</b>						
Naphthalene	28.12	46.84	17.34	7.71	172.50	285.07
Biphenyl	7.20	3.27	10.00	0.00	6.75	1.77
Acenaphthene	2.60	0.28	2.50	0.46	0.00	0.00
1-Methylnaphthalene	6.26	1.41	8.42	5.51	11.03	3.55
2-Methylnaphthalene	9.51	6.40	11.34	8.63	22.38	15.82
2,6-Dimethylnaphthalene	6.73	5.43	8.13	7.70	4.83	1.92
2,3,5-Trimethylnaphthalene	0.00	0.00	6.10	0.00	2.70	0.00
Acenaphthylene	0.00	0.00	0.00	0.00	0.00	0.00
Fluorene	1.54	0.23	2.43	1.04	1.50	0.28
Anthracene	2.58	0.67	0.00	0.00	0.00	0.00
Phenanthrene	3.42	0.79	3.63	0.81	3.50	1.13
1-Methylphenanthrene	3.50	0.00	3.20	0.00	0.00	0.00
Fluoranthene	2.20	0.87	0.00	0.00	0.00	0.00
Pyrene	2.46	0.66	2.10	0.10	4.20	0.00
Chrysene	0.00	0.00	0.00	0.00	0.00	0.00
Benzo(a)anthracene	2.20	0.00	0.00	0.00	0.00	0.00
Benzo(b)fluoranthene	0.00	0.00	0.00	0.00	0.00	0.00
Benzo(k)fluoranthene	0.00	0.00	0.00	0.00	0.00	0.00
Benzo(a)pyrene	0.00	0.00	0.00	0.00	0.00	0.00
Benzo(e)pyrene	2.00	0.00	0.00	0.00	0.00	0.00
Dibenz(a,h)anthracene	3.77	2.06	3.93	1.30	2.90	0.00
Indeno(1,2,3-cd)pyrene	6.15	1.20	4.70	0.00	0.00	0.00
Perylene	0.00	0.00	0.00	0.00	0.00	0.00
Benzo(ghi)perylene	6.23	1.80	3.85	0.21	0.00	0.00
C2 Alkyl naphthalenes	9.89	7.71	20.95	23.19	16.10	12.92
C3 Alkyl naphthalenes	4.71	3.83	10.52	13.90	5.03	4.02
Total PAH ng/L	96.48	NA	87.68		232.29	

**Table 41:** Mean Group 2 Field, Method, and Equipment Blank Dissolved PAH Data

SIT Grab Samples Group 2	Group 2 Mean FB	Group 2 FB Std Dev	Group 2 Mean MB	Group 2 MB Std Dev	Group 2 Mean EB	Group 2 EB Std Dev
Naphthalene	27.08	16.47	43.41	24.60	57.98	23.27
Biphenyl	2.72	1.90	3.53	1.36	8.67	9.60
Acenaphthene	1.00	0.76	1.48	0.91	1.66	0.80
1-Methylnaphthalene	6.07	4.05	10.07	5.65	11.97	5.49
2-Methylnaphthalene	11.68	7.69	20.03	11.93	22.26	10.98
2,6-Dimethylnaphthalene	2.14	1.19	3.33	1.37	3.39	1.00
2,3,5-Trimethylnaphthalene	0.50	0.00	0.00	0.00	0.00	0.00
Acenaphthylene	5.94	13.94	1.47	0.85	1.68	0.48
Fluorene	0.70	0.37	1.07	0.46	1.36	0.39
Anthracene	0.57	0.29	0.99	0.00	1.05	0.12
Phenanthrene	1.94	1.02	2.89	1.29	3.25	0.97
1-Methylphenanthrene	0.62	0.22	1.05	0.31	0.76	0.17
Fluoranthene	0.65	0.35	0.95	0.45	0.96	0.45
Pyrene	0.80	0.27	1.55	0.91	0.89	0.37
Chrysene	0.44	0.33	0.60	0.27	0.60	0.22
Benzo(a)anthracene	0.41	0.52	0.49	0.20	0.49	0.25
Benzo(b)fluoranthene	0.87	0.75	1.31	0.49	1.18	0.26
Benzo(k)fluoranthene	0.71	0.77	2.69	0.00	0.80	0.50
Benzo(a)pyrene	1.55	1.22	3.08	1.09	0.00	0.00
Benzo(e)pyrene	1.75	1.08	3.79	0.00	0.00	0.00
Dibenz(a,h)anthracene	1.39	1.99	3.71	2.30	1.97	0.72
Indeno(1,2,3-cd)pyrene	1.36	1.50	2.29	1.77	1.88	0.75
Perylene	1.56	1.19	3.68	0.00	1.49	0.00
Benzo(ghi)perylene	1.00	0.63	1.97	1.73	1.78	0.71
C2 Alkylnaphthalenes	9.22	5.58	12.79	7.42	12.84	6.22
C3 Alkylnaphthalenes	2.13	2.64	2.37	1.24	3.54	0.56
Total PAH ng/L	73.47	NA	115.43	NA	126.09	NA

### 5.6.3 Dissolved PAH Concentrations

As discussed in Section 5.6.2, some of the dissolved phase PAH target analytes were impacted by blank contamination to a substantial degree. Thus, the use of the data for these analytes, as well as the calculation of dissolved phase total PAH concentrations, must be undertaken with an awareness of the limitations of the dissolved phase PAH data.

Table 42 shows the total dissolved PAH concentrations (ng/L) at all sampling stations during all sampling events, as well as the overall arithmetic mean and standard deviation of this data (also see Figure 55). The highest mean total dissolved PAH concentrations were measured in the Rahway ( $1,388 \pm 1,436$  ng/L) and Elizabeth ( $1,099 \pm 1,228$  ng/L) Rivers. Mean total dissolved PAH concentrations greater than 500 ng/L were measured in the Passaic and Hackensack Rivers (but Station HAC2 = 281 ng/L). At every other sampling station the mean total dissolved PAH concentration was less than 175 ng/L.

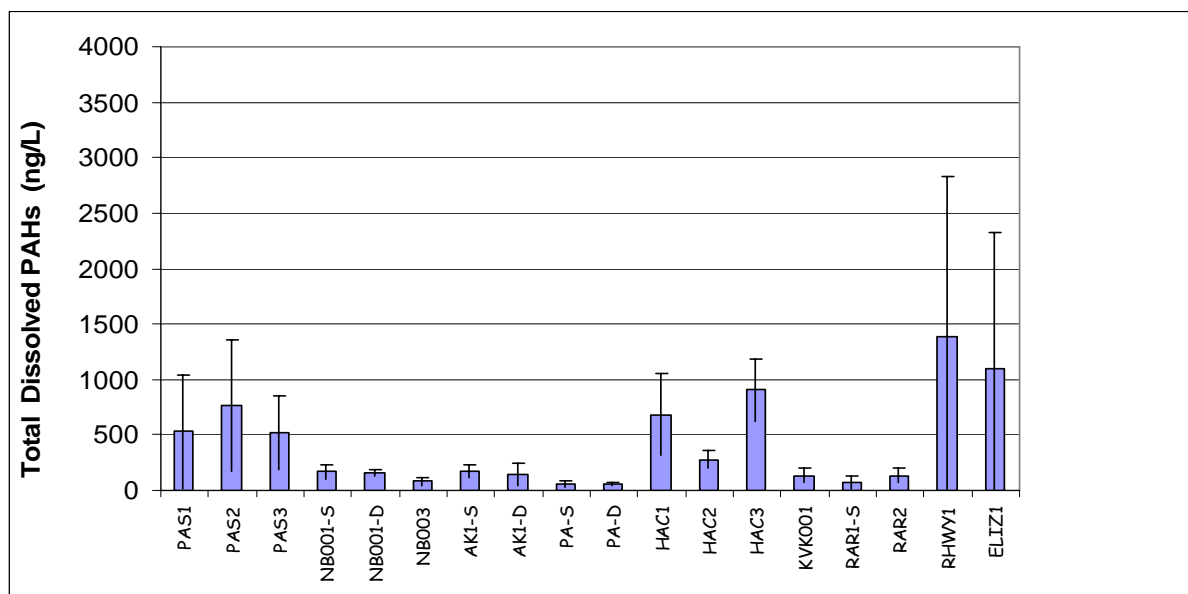
The coefficient of variation of the total dissolved PAH data ranged between 0.200 and 1.117. Variability was generally lower at the Newark Bay, Kills and Hackensack River stations (0.200 – 0.681) compared to the other tributary stations (0.480 - 1.117). Variability decreased in the upstream direction in the Passaic (PAS1 = 0.963, PAS2 = 0.780, PAS3 = 0.637), Hackensack (HAC1 = 0.546, HAC2 = 0.406, HAC3 = 0.308), and Raritan (RAR1-S = 0.808, RAR2 = 0.480) Rivers. The highest variability was found in the Elizabeth (1.117) and Rahway (1.034) Rivers.

Table 42: Total Dissolved PAH Concentration (ng/L)

	6/20-22/00	12/13-15/00	3/13-15/01	4/12/01	4/25/01	5/15/01	5/24/01	10/17-19/01	10/3/01	11/6/01	3/12-14/02	3/27/02	5/14/02	Mean	Std. Dev.
<b>PAS1</b>	*	268	191					1282			369			527	508
<b>PAS2a</b>		**	131					1307			841			760	592
<b>PAS3</b>		387	136					902			648			518	330
<b>NB1-S</b>	*	235	128					218			87			167	71
<b>NB1-D</b>	*	182	118					186			149			159	32
<b>NB3</b>		96	124					73			31			81	39
<b>AK1-S</b>		233	124										158	172	56
<b>AK1-D</b>					127		259			60				149	101
<b>PA-S</b>		53	97				60			26				59	29
<b>PA-D</b>					70		58			38				55	16
<b>HAC1</b>	*	966	777					861			136			685	374
<b>HAC2</b>		396	270					249			207			281	81
<b>HAC3</b>		823	1158					1099			550			908	280
<b>KVK1</b>		133	226					113			70			135	66
<b>RAR1-S</b>				77		27			27			145		69	56
<b>RAR2</b>				111		65			137			217		132	64
<b>RWY1</b>					207		2404			102			2839	1388	1436
<b>ELIZ1</b>					155		2905			688			649	1099	1228

\*Not available due to analytical Quality Assurance concerns.

\*\*The December 2000 sample was collected at Station PAS2 while construction activities were underway just upstream; all other samples were collected at Station PAS2a. Omitted because of a very high value due to this construction.



**Figure 55:** Total mean concentration distributions of Total PAHs in the dissolved phase (ng/L) ± one standard deviation at every sampling station

#### 5.6.4 Suspended Sediment PAH Concentrations

Tables 43 and 44 show the total suspended sediment PAH concentrations at all sampling stations during all sampling events in ng/L and ng/g, respectively, as well as the overall arithmetic mean and standard deviation of this data. Figure 56 shows the mean concentration of Total PAHs in the suspended sediment phase in ng/g at each sampling station.

The highest mean suspended sediment total PAH concentration (ng/L) was measured in the Rahway River (911 ng/L). However, this value was due to the very high May 2002 sample; omitting this sample gives a mean of 295 ng/L. The mean total suspended sediment PAH was also elevated in the Elizabeth River (774 ng/L). But again, this was mostly due to one very high sample (April 2001); omitting this sample gives a mean of 375 ng/L. A mean total suspended sediment PAH concentration > 200 ng/L was found at all three Passaic River stations, in the upper Hackensack River (Station HAC3), and in the upper Arthur Kill (Station AK1-S).

In the Passaic River, suspended sediment total PAH concentration (ng/L) decreased in the upstream direction during the two wet weather/high river flow condition sampling events (Dec 00 and Mar 01). In the Hackensack River, concentrations tended to be higher at the upper Station HAC3, compared to Stations HAC2 and HAC1, during every sampling event. In the Raritan River, the suspended sediment total PAH concentration was higher at Station RAR2 compared to Station RAR1-S during 3 of the 4 sampling events. There was a slight correlation ( $r = 0.35$ ) between suspended sediment total PAHs (ng/L) and SS (mg/L).

The highest mean suspended sediment total PAH concentration (see Table 44 and Figure 56) was measured in the Elizabeth River (90,419 ng/g). However, this value was due to the very high April 2001 sample; omitting this sample gives a mean of 29,523 ng/g. The mean total suspended sediment PAH was also elevated at Station PAS3 (47,488 ng/g). But again, this was due to one high sample (December 2000); omitting this sample gives a mean of 18,636 ng/g. Mean total suspended sediment PAH concentrations > 20,000 ng/g sed were found at all three Passaic River stations, in the lower Hackensack River (Station HAC1), in the Rahway River, and in the upper Arthur Kill (Station AK1-S). In general, mean concentrations in the tributaries (except for Stations HAC3 and RAR1-S) were greater than those at the estuarine sampling locations.

The coefficient of variation of the total suspended sediment PAH data (ng/g) ranged between 0.096 and 1.363. The lowest variability was, by far, found at Station AK1-S (0.096); however, the variability was high (1.205) in the samples collected at Station AK1-D. Variability < 0.70 was observed in the lower Passaic River (Station PAS1), upper Newark Bay, the Kill van Kull, and in the mid/upper Hackensack River (Stations HAC2/3). Variability was high (> 0.90) at the remaining stations, except those in the Raritan River and Station NB3.

In the Raritan River, the suspended sediment total PAH concentration (ng/g) was higher at Station RAR2 compared to Station RAR1-S during all of the sampling events.

Over all sampling stations, there was no correlation ( $r = -0.13$ ) between suspended sediment total PAHs (ng/g sed) and SS (mg/L). There was a moderate correlation between suspended sediment total PAHs (ng/g sed) and suspended sediment total PAHs (ng/L):  $SSTotalPAH [ng/L] = 0.007 * SSTotalPAH [ng/g sed] + 103$ ;  $r=0.60$ .

Mean Total Suspended Sediment PAH concentrations (ug/g POC; data not shown) were highest at Station ELIZ1 ( $901 \pm 1,235$  ug/g POC), with mean concentrations at Stations PAS1, HAC1, and RWY1 between 432 and 484 ug/g POC. Mean values at the remaining stations were less than 371 ug/g POC, with the lowest values in Stations RAR1-S (79 ug/g POC) and PA-D (48 ng/g POC).

### 5.6.5 Total PAH Concentrations

Table 45 shows the Total PAH concentrations (dissolved + suspended sediment fractions; ng/L) at all sampling stations during all sampling events, as well as the overall arithmetic mean and standard deviation of this data. Figure 56 shows the mean concentrations at each sampling station. As discussed in Section 5.6.2, some of the dissolved phase PAH target analytes were impacted by blank contamination to a substantial degree. **Thus, the calculation of total PAH (dissolved + suspended sediment fraction) concentrations must be undertaken with an awareness of the limitations of the dissolved phase PAH data.**

On average 60% of the total PAHs are in the dissolved phase (although this percentage is actually higher because of the blank contamination impacts on the dissolved fraction data). The

highest mean total PAH concentrations (> 1,200 ng/L) are measured in the Rahway River, the Elizabeth River, and the upper Hackensack River (Station HAC3). In general, mean concentrations in the tributaries (except for the Raritan River) were greater than those at the estuarine sampling locations. In the Hackensack River, total PAH concentrations (ng/L) were higher at the upper Station HAC3, compared to Stations HAC2 and HAC1, during every sampling event. In the Raritan River, the total PAH concentration was higher at Station RAR2 compared to Station RAR1-S during all of the sampling events.

The coefficient of variation of the total PAH data (ng/L) ranged between 0.224 and 1.084 (Rahway River). Variability < 0.60 was found at 13 of the 18 sampling stations.

Even though >60% of the Total PAHs were found in the dissolved phase, there was a moderate correlation between total PAHs (ng/L) and SS (mg/L):

$$\text{Total PAH [ng/L]} = 22.9 * \text{SS [mg/L]} + 214.3; r = 0.62.$$

**Table 43: Suspended Sediment Total PAH Concentration (ng/L)**

	6/20- 22/00	12/13- 15/00	3/13- 15/01	4/12/01	4/25/01	5/15/01	5/24/01	10/17- 19/01	10/3/01	11/6/01	3/12- 14/02	3/27/02	5/14/02	Mean	Std. Dev.
PAS1		551	372					199			286			352	150
PAS2a		406	210					144			NA			253	136
PAS3		311	44					187			473			254	182
NB1-S		281	130					55			96			141	99
NB1-D		167	112					36			100			104	54
NB3		166	91					15			55			82	64
AK1-S		287	183										170	213	64
AK1-D					207		32			16				85	106
PA-S		81	297				54			11				111	127
PA-D					87		34			11				44	39
HAC1		84	549					64			101			200	233
HAC2		237	172					90			101			150	68
HAC3		480	547					135			318			370	184
KVK1		213	158					15			100			121	85
RAR1-S				198		14			4			138		88	95
RAR2				190		50			36			171		112	80
RWY1					429		431			26			2759	911	1246
ELIZ1					1969		814			9			302	774	864

**Table 44: Suspended Sediment Total PAH Concentration (ng/g)**

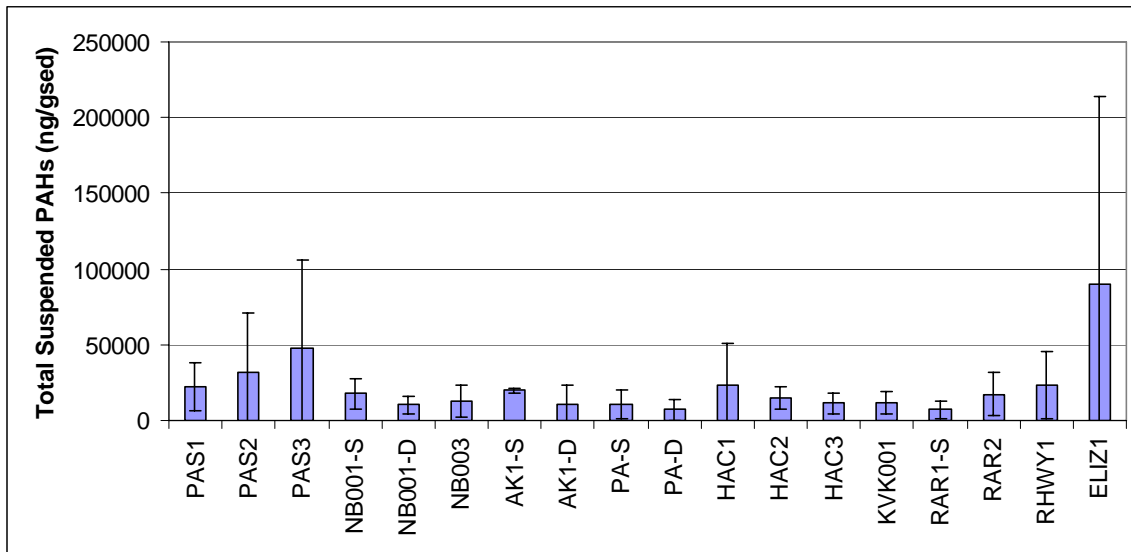
	6/20- 22/00	12/13- 15/00	3/13- 15/01	4/12/01	4/25/01	5/15/01	5/24/01	10/17- 19/01	10/3/01	11/6/01	3/12- 14/02	3/27/02	5/14/02	Mean	Std. Dev.
PAS1		17178	39409					2966			30304			22464	15882
PAS2a		*	59149					4539						31844	38615
PAS3		134044	24408					4864			26635			47488	58527
NB1-S		25051	21187					3044			22625			17977	10082
NB1-D		10119	12371					2796			16637			10481	5792
NB3		27484	11123					1616			10669			12723	10771
AK1-S		20154	17684										21424	19754	1902
AK1-D					25727		3788			2778				10764	12968
PA-S		8872	23864				5548			2494				10195	9478
PA-D					15132		2263			3628				7007	7069
HAC1		2923	60400					2960			27824			23527	27237
HAC2		13543	17538					4667			22852			14650	7670
HAC3		9346	21224					4881			10169			11405	6946
KVK1		17280	15346					979			12202			11452	7289
RAR1-S				13659		3641			1412			9180		6973	5526
RAR2				30698		7221			2958			28236		17278	14217
RWY1					37597		4269			4989			46518	23343	21916
ELIZ1					273107		35237			4176			49156	90419	123235

\*The December 2000 sample was collected at Station PAS2 while construction activities were underway just upstream; all other samples were collected at Station PAS2a. Omitted because of a very low value due to this construction.

**Table 45: Total PAH Concentration (ng/L)**

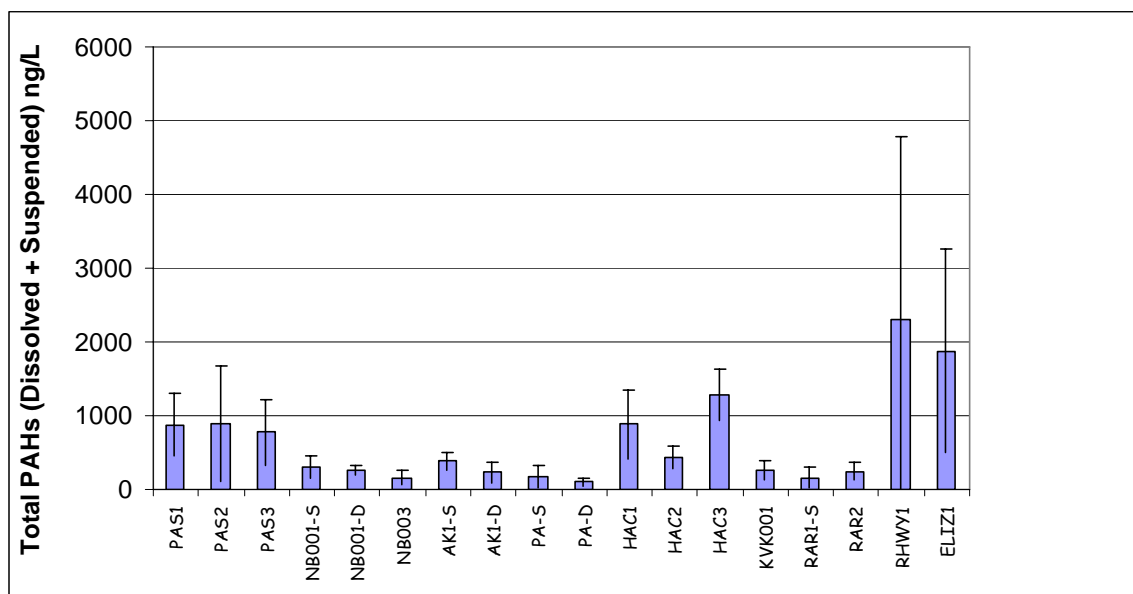
	6/20-22/00	12/13-15/00	3/13-15/01	4/12/01	4/25/01	5/15/01	5/24/01	10/17-19/01	10/3/01	11/6/01	3/12-14/02	3/27/02	5/14/02	Mean	Std. Dev.
PAS1		820	563					1481			656			880	415
PAS2a		*	341					1451			NA			896	785
PAS3		698	180					1089			1121			772	439
NB1-S		516	258					272			183			307	145
NB1-D		349	230					223			249			263	59
NB3		262	215					88			86			163	90
AK1-S		520	306										328	385	118
AK1-D					334		291			76				234	138
PA-S		134	394				114			36				169	156
PA-D					157		92			48				99	55
HAC1		1049	1325					929			236			885	463
HAC2		633	442					339			308			428	149
HAC3		1303	1705					1234			868			1278	343
KVK1		346	383					127			170			256	127
RAR1-S				275		41			31			284		158	141
RAR2				298		116			173			388		244	123
RWY1					636		2835			128			5598	2299	2493
ELIZ1					2124		3719			697			951	1873	1379

\*The December 2000 sample was collected at Station PAS2 while construction activities were underway just upstream; all other samples were collected at Station PAS2a. Omitted because of a very high value due to this construction.



**Figure 56: Mean concentration ± one standard deviation of Total PAHs in the suspended sediment phase (ng/g) at every sampling station**





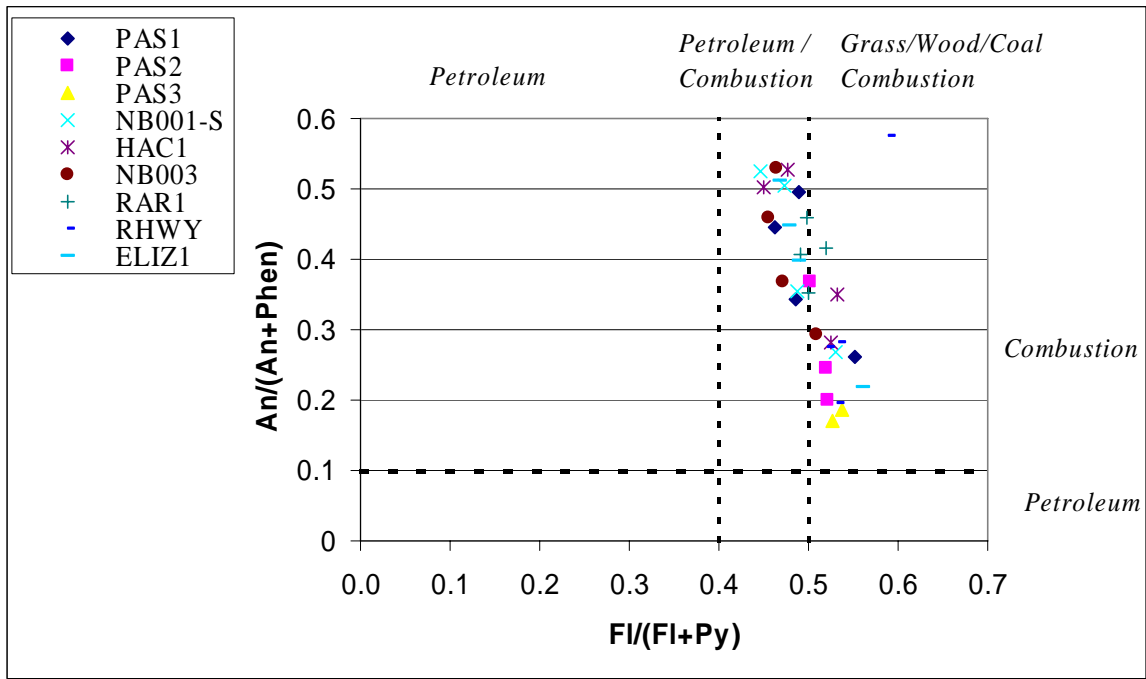
**Figure 57:** Mean concentration  $\pm$  one standard deviation of Total PAHs (dissolved + suspended sediment fractions; ng/L) at every sampling station

### 5.6.6 Source Identification based on PAH Target Analyte Distribution

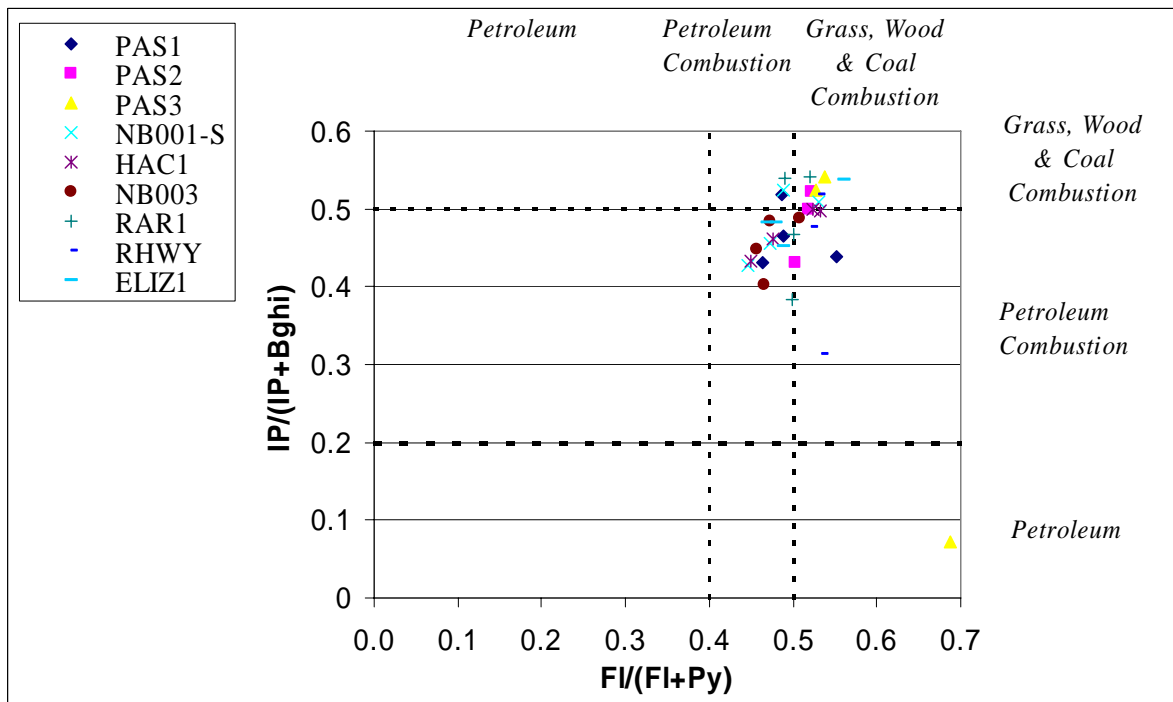
Parent and alkyl-substituted PAHs have both natural sources (coal, oil seeps, forest and prairie fires) and anthropogenic sources (fossil fuels and combustion).

PAHs of molecular mass 178 and 202 are commonly used to distinguish between combustion and petroleum sources (Gschwend and Hites, 1981). For mass 178, an anthracene to anthracene plus phenanthrene (An/(An+Phen)) ratio of less than 0.10 indicates the presence of petroleum products, whereas a ratio of greater than 0.10 indicates a dominance of combustion. For mass 202, a fluoranthene to fluoranthene plus pyrene (Fl/(Fl+Py)) ratio of 0.50 is usually defined as the petroleum/combustion transition point (Budzinski et al, 1997). As seen in Figure 58, based on the An/(An+Phen) vs. the Fl/(Fl+Py) ratios, combustion of petroleum and gas/wood/coal is the main source of PAHs in New York-New Jersey Harbor. This is to be expected for this urbanized region.

PAHs of molecular mass 228 and 276 are used less frequently as parent PAH indicators. For mass 276, an indeno[1,2,3-cd]pyrene to a indeno[1,2,3-cd]pyrene plus benzo[ghi]perylene (IP/(IP+Bghi)) ratio less than 0.20 likely indicates petroleum products, and greater than 0.5 implies combustion. As seen in Figure 59, based on the IP/(IP+Bghi) vs. the Fl/(Fl+Py) ratios combustion is also the main source of PAHs in the harbor.



**Figure 58:** PAH cross plots for the ratio of An/(An+Phen) vs. Fl/(Fl+Py)



**Figure 59:** PAH cross plots for the ratio of IP/(IP+Bghi) vs. Fl/(Fl+Py)

### 5.6.7 PAHs - Conclusions

- (1) Some of the dissolved phase PAH target analytes were impacted by blank contamination to a substantial degree. Thus, the use of the data for these analytes, as well as the calculation of total PAH concentrations, is problematical.
- (2) The highest mean suspended sediment total PAH concentrations ( $> 20,000$  ng/g sed) were measured in the Elizabeth River, at all three Passaic River stations, in the lower Hackensack River (Station HAC1), in the Rahway River, and in the upper Arthur Kill (Station AK1-S). There was no correlation ( $r = -0.13$ ) between suspended sediment total PAHs (ng/g sed) and SS (mg/L).
- (3) The highest mean total PAH concentrations ( $> 1,200$  ng/L; dissolved + suspended sediment fractions) were measured in the Rahway River, the Elizabeth River, and the upper Hackensack River (Station HAC3). Even though  $>60\%$  of the Total PAHs were found in the dissolved phase, there was a moderate correlation ( $r = 0.62$ ) between total PAHs (ng/L) and SS (mg/L).
- (4) Based on the concentration ratios of some of the target analytes, it appears that combustion of petroleum and grass/wood/coal are the main sources of PAHs in New York-New Jersey Harbor.
- (5) New Jersey Saline Human Health Water Quality Criteria (WQC; suspended + dissolved fractions) have been established for a number of individual PAH compounds. The WQC for benzo(a)pyrene (18 ng/L) was exceeded at all of the sampling locations in the tidal Passaic, Hackensack, Elizabeth, and Rahway Rivers, and at sampling Stations NB1-S and AK1-S. The WQC for dibenz(a,h)anthracene (18 ng/L) was exceeded by the mean concentration in the Rahway River.

## 5.7 Pesticides

### 5.7.1 Sample Analysis

The TOPS XAD (dissolved phase) and TOPS Filter (suspended sediment) samples were analyzed for 27 individual organochlorine pesticides (see Table 1) using high-resolution gas chromatography and mass spectrometry (HRGC/HRMS) with isotope dilution. This analytical method was developed based on guidance from USEPA Method 1613, USEPA Draft Method 1668, and NYSDEC Draft Method HRMS-2.

The detection limit achieved for each organochlorine pesticide target analyte varied among the samples, due to analytical differences as well as differences in sample size. Considering all pesticides, the mean detection limit for the dissolved samples (n = 69) ranged between 0.0018 and 0.1413 ng/L, with a mean  $\pm$  standard deviation of  $0.0137 \pm 0.0195$  ng/L. The mean detection limit for the suspended sediment phase (TOPS filter) samples (n = 67), ranged between 0.0004 and 0.0460 ng/L, with a mean  $\pm$  standard deviation of  $0.0084 \pm 0.0106$  ng/L; and between 0.0017 and 4.29 ng/g sed, with a mean  $\pm$  standard deviation of  $0.60 \pm 0.76$  ng/g sed.

### 5.7.2 NJTRWP Blank Correction

The sample data was subjected to a preliminary Quality Assurance Verification Review. In addition, because of the nature of the samples and the trace concentrations expected for the target analytes, a “maximum blank” approach was developed to assess the impact of background contamination on the usability of the sample data. For each survey, one (1) Equipment Blank (XAD resin, dissolved fraction only) was prepared in the laboratory by pumping four (4) liters of water supplied by the analytical laboratory through a TOPS after it had been cleaned and prepared for sampling. One (1) TOPS Filter set and one (1) XAD resin column Field Blank were collected at each sampling location. The TOPS Filter Field Blank was collected by exposing a set of TOPS filters to the surrounding air while the TOPS filters that were used for sampling were installed and removed from the sampling equipment. Likewise, for the XAD Field Blank, a TOPS XAD resin column was exposed to the surrounding air (by opening the end caps on the column) while the TOPS XAD resin columns that were used for sampling were installed and removed from the sampling equipment. The Field Blanks from one of the sites in each survey were analyzed in the same manner as their associated samples; the remaining Field Blanks were archived. At least one (1) laboratory Method Blank was also prepared and analyzed by the analytical laboratory for each Sample Delivery Group (SDG). That blank having the largest value (the “maximum blank”) was used to assess the effect of background contamination on the sample data for that survey (see Section 4.3). In order for a sample result to be usable, it must have been at least five times (5X) greater than the “maximum blank”. No other blank correction was performed on the sample data.

The dissolved fraction (TOPS XAD) samples were frequently impacted by blank contamination only for hexachlorobenzene, methoxychlor, 2,4'-DDT, and particularly heptachlor (64 of 69

samples). The suspended sediment (TOPS Filter) samples were occasionally impacted by blank contamination only for methoxychlor (Table 46).

**Table 46:** Number of Pesticide Samples Impacted by Blank Contamination

<b>Pesticide</b>	<b>XAD samples affected by blank contamination (n=69)</b>	<b>Filter samples affected by blank contamination (n=67)</b>
Hexachlorobenzene	34	
Gamma-BHC (Lindane)		3
Gamma-Chlordane	1	
2,4'-DDE		1
2,4'-DDT	31	
4,4'-DDT	2	
Aldrin	1	
Alpha-Endosulfan	6	
Heptachlor	64	2
Methoxychlor	28	11

### 5.7.3 QA Issues

The preliminary Quality Assurance Verification Review conducted on the pesticides samples included an evaluation of the recovery of Internal Standards analyzed with each sample compared to the established Quality Control limits. For some target analytes in some samples, the associated Internal Standard was either not recovered or recovered at approximately 0%; the data for these analytes is thus “Not Reportable” (NR). The only “Not Reportable” analytes in more than one (1) sample were the various endosulfan and endrin compounds: 14 of 67 TOPS filter samples (21%) were NR for these analytes. Samples from all five tributary rivers were so affected, but none of the estuarine samples were NR for these analytes.

Those target analytes for which the associated Internal Standard recovery was less than fifty per cent (< 50%) of the Quality Control limit were considered to be “rejected” for use. This was a rare occurrence: of 67 TOPS filter samples, the data for 4 samples (6%) were rejected for the various DDT compounds, 3 samples (4.5%) were rejected for methoxychlor, dieldrin, heptachlor epoxide, and the various endosulfan and endrin compounds (in addition to the 21% that were NR), and 2 samples (3%) were rejected for gamma-BHC and hexachlorobenzene. In addition, 3 of 69 XAD samples (4.3%) were rejected for alpha-BHC.

In summary, poor Internal Standards recoveries resulting in the “loss” of usable sample data were largely limited to 17 of the 67 TOPS Filter samples (25%) for the various endosulfan and endrin compounds.

#### 5.7.4 Dissolved Total Pesticides Concentrations

Table 47 presents the dissolved Total pesticides concentrations (ng/L) at all sampling stations during all sampling events, as well as the overall arithmetic mean and standard deviation of this data (also see Figure 60).

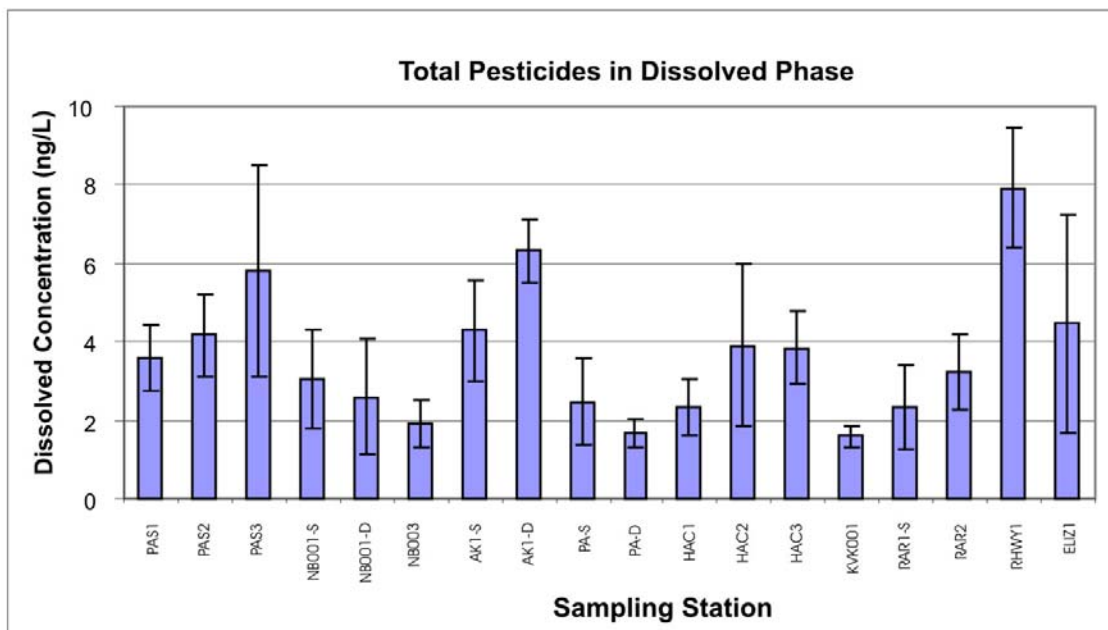
Over all sampling stations and surveys (n = 73 samples), the percentage of Total pesticides (dissolved + suspended sediment fractions) that is in the dissolved phase ranges from 9.6 to 89.6%, with a mean  $\pm$  standard deviation of  $53.4 \pm 18.9\%$ , and a median of 55.9%. The mean percentage of dissolved pesticides at the tributary stations ( $50.6 \pm 21.1\%$ ) did not differ from that at the estuary stations ( $56.7 \pm 15.6\%$ ). Elevated mean percentage dissolved Total pesticides were found at Stations HAC2 (70.8%) and NB3 (70.3%). Low mean percentage dissolved Total pesticides were found at Station PAS1 (34.6%) and in the Elizabeth (37.3%) and Rahway (25.6%) Rivers.

The highest mean concentration was measured in the Rahway River ( $7.94 \pm 1.53$  ng/L), and the lowest concentrations were in lower Newark Bay (Station NB3 =  $1.92 \pm 0.58$  ng/L), the Kill van Kull ( $1.60 \pm 0.30$  ng/L), and the southern Arthur Kill (Station PA-D =  $1.68 \pm 0.34$  ng/L). Along the rivers with more than one sampling station along their tidal stretches (the Passaic, Hackensack, and Raritan Rivers), there was a tendency for the mean Total dissolved pesticide concentration, as well as the individual sample concentrations during most of the surveys, to increase in the upstream direction.

The coefficient of variation of the dissolved Total pesticides data ranged between 0.127 and 0.628. The coefficient of variation was greater than 0.50 at only three stations (HAC2 = 0.528, ELIZ = 0.628, and NB1-D = 0.548).

**Table 47: Dissolved Total Pesticides Concentration (ng/L)**

	6/20- 22/00	12/13- 15/00	3/13- 15/01	4/12/01	4/25/01	5/15/01	5/24/01	10/17- 19/01	10/3/01	11/6/01	3/12- 14/02	3/27/02	5/14/02	Mean	Std. Dev.
PAS1	4.74	3.23	4.14					3.13			2.72			3.59	0.82
PAS2		3.48	3.23					5.58			4.32			4.15	1.06
PAS3		5.28	3.00					5.44			9.50			5.81	2.70
NB001-S	5.11	3.08	2.62					2.70			1.82			3.06	1.23
NB001-D	4.10	1.29	3.73					2.38			1.08			2.52	1.38
NB003		2.54	2.07					1.92			1.14			1.92	0.58
AK1-S		5.62	3.08										4.15	4.29	1.28
AK1-D					7.01		6.52			5.43				6.32	0.81
PA-S		3.97	2.72				1.70			1.51				2.48	1.13
PA-D					1.45		2.07			1.51				1.68	0.34
HAC1	3.47	2.24	2.26					2.17			1.51			2.33	0.71
HAC2		2.41	3.23					6.98			3.06			3.92	2.07
HAC3		2.91	4.64					3.19			4.65			3.85	0.93
KVK001		1.51	1.79					1.89			1.23			1.60	0.30
RAR1-S				2.89		2.17			3.34			0.90		2.32	1.07
RAR2				4.52		3.19			3.02			2.25		3.24	0.95
RHWY1					8.53		7.68			5.96			9.57	7.94	1.53
ELIZ1					2.82		8.66			3.14			3.24	4.46	2.80



**Figure 60: Mean concentration  $\pm$  one standard deviation dissolved Total pesticides (ng/L) at each sampling station.**

#### 5.7.4.1 Dissolved Total DDT

Total DDT (and metabolite) concentrations are calculated by adding the measured concentrations of the following compounds: 2,4'-DDD, 2,4'-DDE, 2,4'-DDT, 4,4'-DDD, 4,4'-DDE, and 4,4'-DDT.

Table 48 presents the dissolved Total DDT concentrations (ng/L) at all sampling stations during all sampling events, as well as the overall arithmetic mean and standard deviation of this data (also see Figure 61).

Over all sampling stations and surveys (n = 71 samples), the percentage of Total DDT (dissolved + suspended sediment fractions) that is in the dissolved phase ranges from 4.6 to 75.6%, with a mean  $\pm$  standard deviation of  $30.1 \pm 16.0\%$ , and a median of 28.3%. The mean percentage of dissolved Total DDT at the tributary stations ( $26.6 \pm 17.4\%$ ) did not differ from that at the estuary stations ( $35.4 \pm 14.7\%$ ).

The highest mean concentrations were measured in the Rahway River (3.21 ng/L) and northern Arthur Kill (Station AK1-D = 3.33 ng/L, Station AK1-S = 1.88 ng/L). Mean concentrations were less than 0.90 ng/L at all of the other stations.

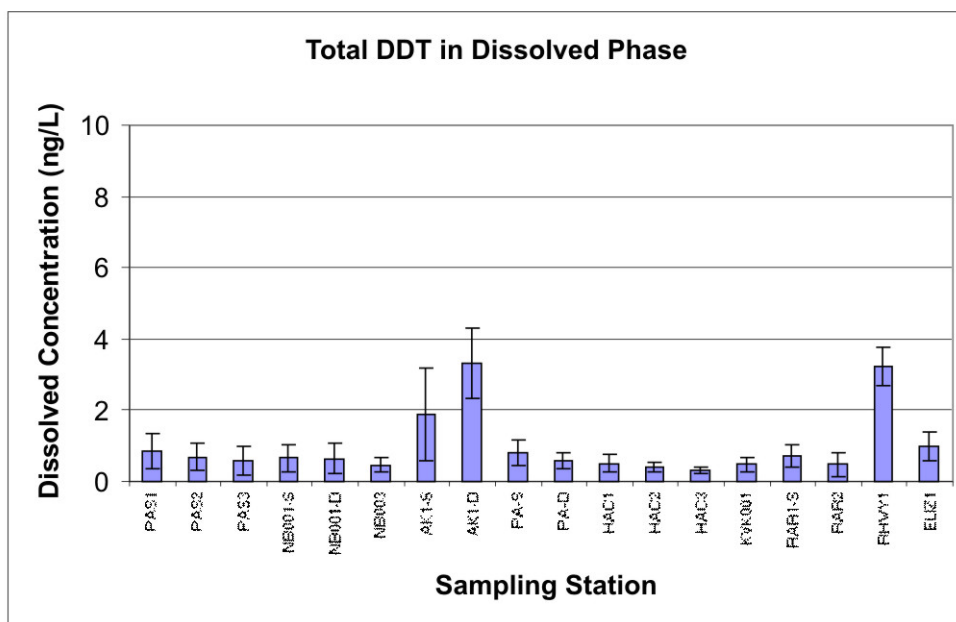
The coefficient of variation (ratio of the standard deviation over the arithmetic mean, an indicator of data variability) of the dissolved Total DDT data ranged between 0.169 and 0.697. The coefficient of variation was greater than 0.60 at only four stations – PAS3, RAR2, NB1-D, and AK1-S.

Figures 62, 63, and 64 show the mean dissolved concentrations of the individual compounds 4,4'-DDD, 4,4'-DDE, and 4,4'-DDT, respectively, at each sampling station. The mean 4,4'-DDD concentration in the dissolved phase is elevated at sampling stations RHWY1 (1.92 ng/L), AK1-S (1.09 ng/L), and AK1-D (1.96 ng/L). At all of the other stations, the mean dissolved 4,4'-DDD concentration is less than 0.6 ng/L. The mean dissolved 4,4'-DDE concentration exceeds 0.15 ng/L at Stations RHWY1, NB1-D, AK1-S, and AK1-D. At most sampling stations the mean dissolved 4,4'-DDE concentration is less than 0.10 ng/L. Elevated mean dissolved 4,4'-DDT concentrations are observed at stations PAS1 (0.064 ng/L), ELIZ1 (0.084 ng/L), RHWY1 (0.10 ng/L), and AK1-D (0.057 ng/L). At most of the other stations, the mean dissolved 4,4'-DDT concentration is less than 0.04 ng/L.

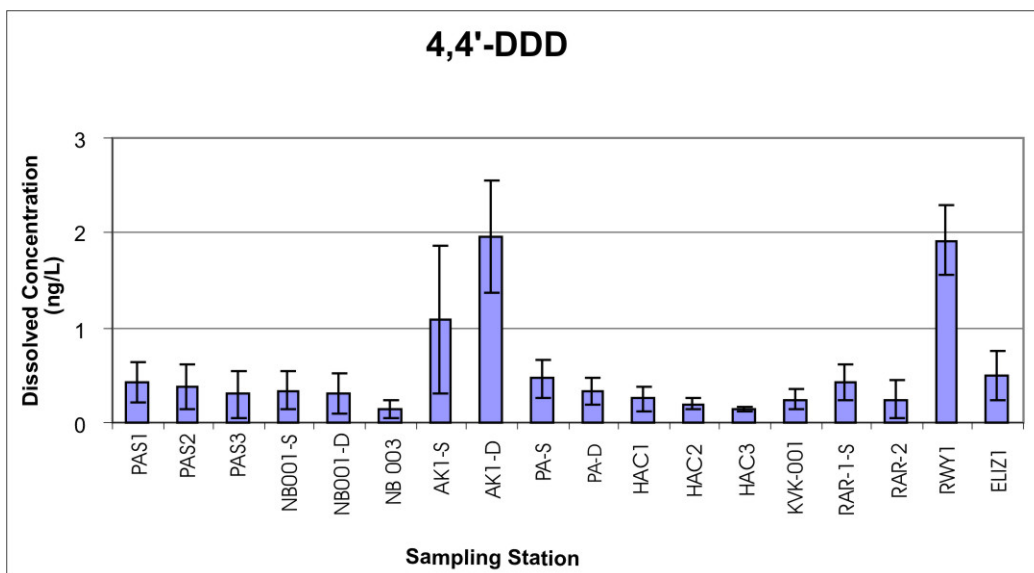


**Table 48: Dissolved Total DDT Concentration (ng/L)**

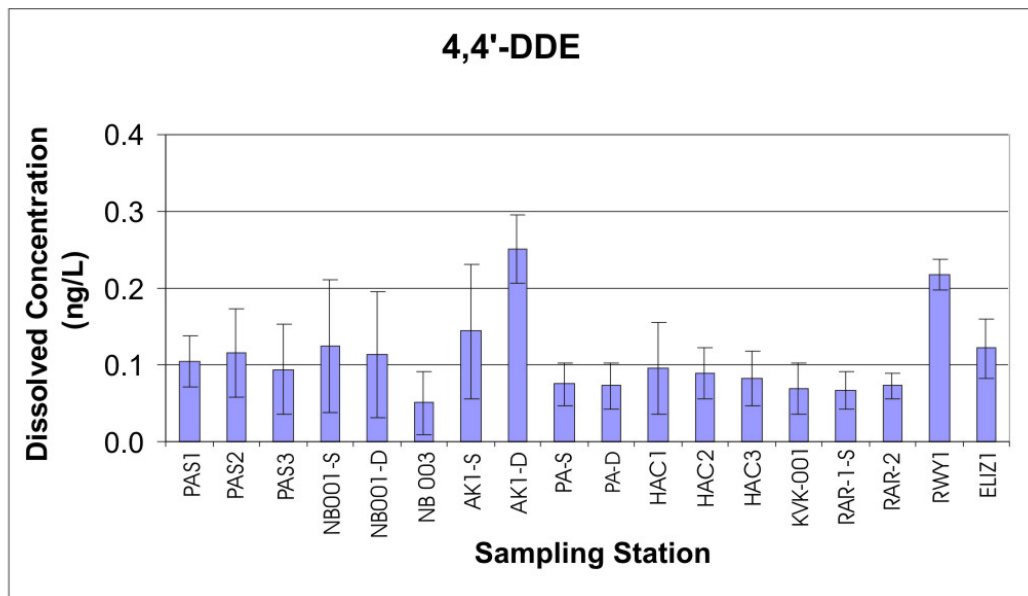
	6/20- 22/00	12/13- 15/00	3/13- 15/01	4/12/01	4/25/01	5/15/01	5/24/01	10/17- 10/11/01	10/3/01	11/6/01	3/12- 11/02	3/27/02	5/14/02	Mean	Std. Dev.
PAS1	1.69	0.83	0.70					0.68			0.41			0.86	0.49
PAS2		0.56	0.32					1.23			0.67			0.69	0.39
PAS3		0.24	0.22					0.90			0.93			0.57	0.40
NB001-S	1.31	0.53	0.43					0.72			0.34			0.67	0.39
NB001-D	1.35	0.36	0.69					0.61			0.20			0.64	0.44
NB003		0.73	0.38					0.47			0.25			0.46	0.21
AK1-S	2.94	0.41											2.30	1.88	1.31
AK1-D					2.23		4.12			3.66				3.33	0.99
PA-S		1.32	0.76					0.59			0.56			0.81	0.35
PA-D					0.37		0.84			0.55				0.58	0.24
HAC1	0.91	0.51	0.37					0.48			0.25			0.50	0.25
HAC2		0.32	0.37					0.60			0.35			0.41	0.13
HAC3		0.26	0.32					0.21			0.41			0.30	0.08
KVK001		0.44	0.38					0.77			0.29			0.47	0.21
RAR1-S				0.71		0.91			1.00			0.29		0.72	0.32
RAR2				0.29		0.46			0.93			0.21		0.47	0.32
RHWY1					3.33		2.48			3.79			3.25	3.21	0.54
ELIZ1					0.79		0.84			1.58			0.76	0.99	0.39



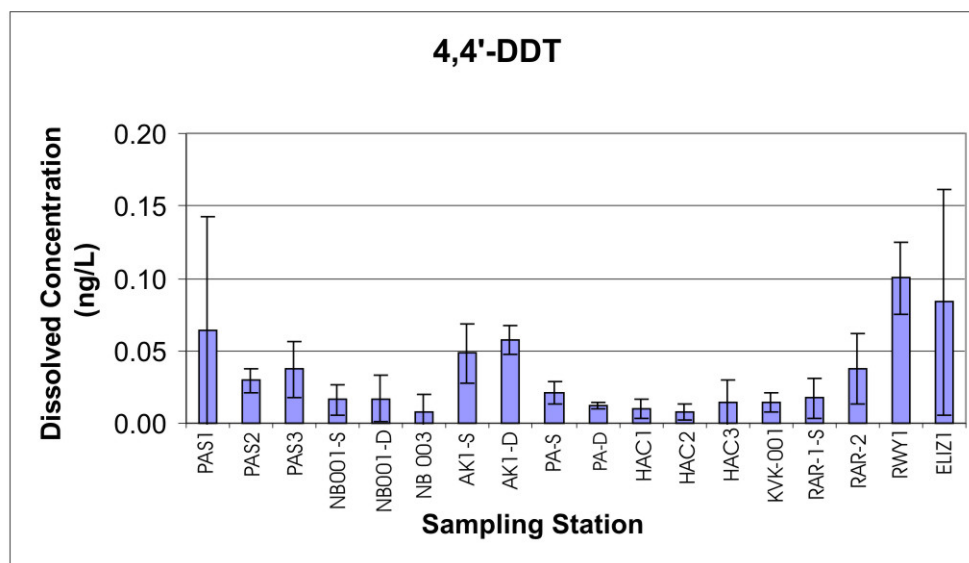
**Figure 61: Mean ± standard deviation dissolved Total DDT concentration (ng/L) at each sampling station.**



**Figure 62:** Mean  $\pm$  standard deviation dissolved 4,4'-DDD concentration (ng/L) at each sampling station.



**Figure 63:** Mean  $\pm$  standard deviation dissolved 4,4'-DDE concentration (ng/L) at each sampling station.



**Figure 64:** Mean  $\pm$  standard deviation dissolved 4,4'-DDT concentration (ng/L) at each sampling station.

#### 5.7.4.2 Dissolved Total Chlordanes

The Total Chlordane concentrations are calculated by adding the measured concentrations of the following compounds: trans-nonachlor, cis-nonachlor, oxy-Chlordane, alpha-Chlordane, and gamma-Chlordane. Table 49 presents the dissolved Total Chlordane concentrations (ng/L) at all sampling stations during all sampling events, as well as the overall arithmetic mean and standard deviation of this data (see Figure 65).

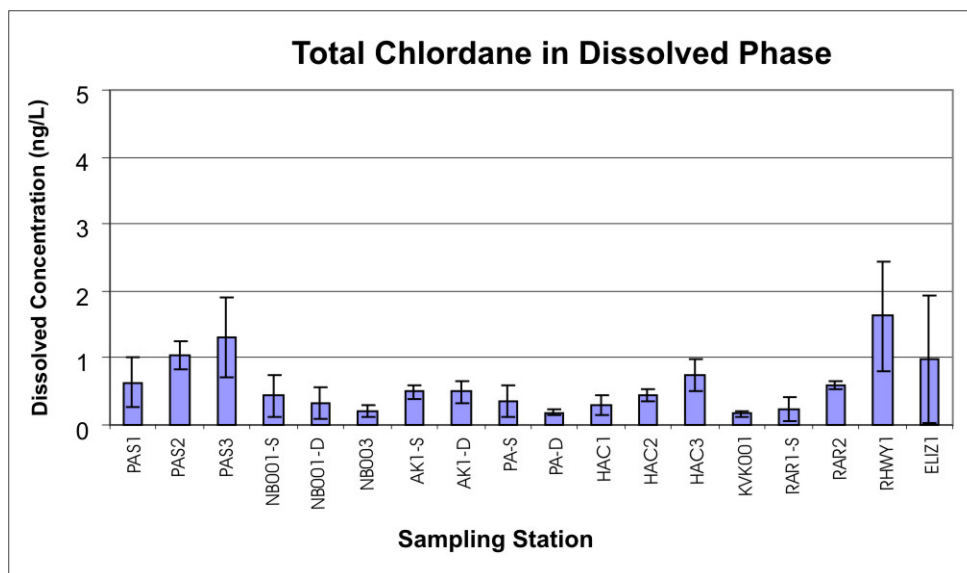
Over all sampling stations and surveys ( $n = 73$  samples), the percentage of Total Chlordane (dissolved + suspended sediment fractions) that is in the dissolved phase ranges from 9.4 to 91.2%, with a mean  $\pm$  standard deviation of  $46.2 \pm 19.0\%$ , and a median of 47.3%. The mean percentage of dissolved Total Chlordane at the tributary stations ( $41.5 \pm 20.0\%$ ) did not differ from that at the estuary stations ( $51.9 \pm 16.3\%$ ). A relatively low mean percentage dissolved Total Chlordanes was found in the Elizabeth (11.8%) and Rahway (15.7%) Rivers.

The highest mean dissolved concentrations are measured in the Rahway River (1.62 ng/L), in the mid/upper-Passaic River (Station PAS2 = 1.04 ng/L and Station PAS3 = 1.31 ng/L), and in the Elizabeth River (0.98 ng/L). Mean concentrations at all of the other sampling stations were less than 0.75 ng/L. Along the rivers with more than one sampling station along their tidal stretches (the Passaic, Hackensack, and Raritan Rivers), there was a tendency for the mean dissolved Total Chlordane concentration, as well as the individual sample concentrations during most of the surveys, to increase in the upstream direction. This is similar to what was observed for total dissolved pesticides (see Section 5.74).

The coefficient of variation of the dissolved Total Chlordane data ranged between 0.103 and 0.981. The coefficient of variation was greater than 0.50 at Stations PAS1, NB1-S, NB1-D, PA-S, RAR1-S, and ELIZ.

**Table 49:** Dissolved Total Chlordane Concentrations (ng/L)

	6/20- 22/00	12/13- 15/00	3/13- 15/01	4/12/01	4/25/01	5/15/01	5/24/01	10/17-19/01	10/3/01	11/6/01	3/12- 14/02	3/27/02	5/14/02	Mean	Std. Dev.
PAS1	1.07	0.44	1.03					0.34			0.31			0.64	0.38
PAS2		0.84	1.23					1.20			0.90			1.04	0.20
PAS3		0.81	0.94					1.35			2.15			1.31	0.61
NB001-S	0.93	0.28	0.48					0.27			0.20			0.43	0.30
NB001-D	0.67	0.16	0.49					0.21			0.11			0.33	0.24
NB003		0.21	0.33					0.19			0.13			0.22	0.08
AK1-S		0.53	0.59										0.39	0.50	0.10
AK1-D					0.51		0.65			0.32				0.49	0.16
PA-S		0.69	0.31				0.24			0.15				0.35	0.24
PA-D					0.18		0.23			0.15				0.19	0.04
HAC1	0.55	0.28	0.33					0.21			0.16			0.30	0.15
HAC2		0.36	0.55					0.49			0.42			0.45	0.08
HAC3		0.62	1.05					0.48			0.79			0.73	0.24
KVK001		0.13	0.21					0.19			0.14			0.17	0.04
RAR1-S				0.48		0.23			0.19			0.07		0.24	0.17
RAR2				0.56		0.58			0.69			0.58		0.60	0.06
RHWY1					1.79		2.16			0.43			2.11	1.62	0.81
ELIZ1					0.60		2.40			0.26			0.66	0.98	0.96



**Figure 65:** Mean  $\pm$  standard deviation dissolved Total Chlordane concentration (ng/L) at every sampling station.

#### 5.7.4.3 Dissolved Dieldrin

Table 50 presents the dissolved Dieldrin concentrations (ng/L) at all sampling stations during all sampling events, as well as the overall arithmetic mean and standard deviation of this data (also see Figure 66).

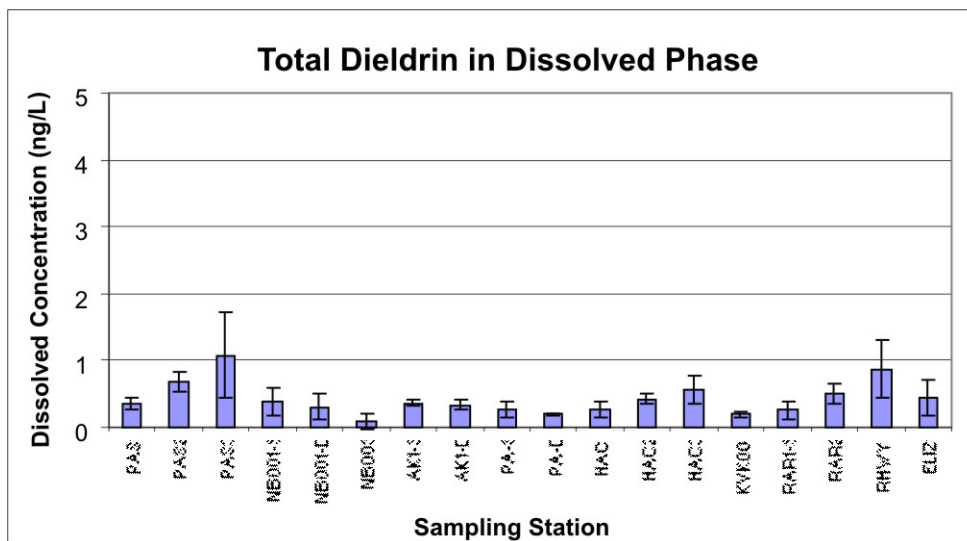
Over all sampling stations and surveys ( $n = 73$  samples), the percentage of Total Dieldrin (dissolved + suspended sediment fractions) that is in the dissolved phase ranges from 0 to 99.8%, with a mean  $\pm$  standard deviation of  $76.9 \pm 19.3\%$ , and a median of 80.8%. The mean percentage of dissolved Dieldrin at the tributary stations ( $74.5 \pm 15.5\%$ ) did not differ from that at the estuary stations ( $79.6 \pm 23.6\%$ ). Omitting the two March 2001 samples at Stations NB1-D and NB-3 with 0%, and the April 2001 Elizabeth River sample with 26.7%, the percentage dissolved Dieldrin was greater than 44% in the remaining 70 samples.

The highest mean concentrations are measured in the Rahway River (0.87 ng/L), and the mid/upper Passaic River (Station PAS2 = 0.69 ng/L and Station PAS3 = 1.08 ng/L). Mean concentrations at all of the other sampling stations were less than 0.6 ng/L. Along the rivers with more than one sampling station along their tidal stretches (the Passaic, Hackensack, and Raritan Rivers), there was a tendency for the mean dissolved Dieldrin concentration, as well as the individual sample concentrations during most of the surveys, to increase in the upstream direction. This is similar to what was observed for total dissolved pesticides (see Section 5.74).

The coefficient of variation of the dissolved Dieldrin data ranged between 0.119 and 0.813. The coefficient of variation was greater than 0.60 at Stations NB1-D and NB3.

**Table 50: Dissolved Dieldrin Concentration (ng/L)**

	6/20- 22/00	12/13- 15/00	3/13- 15/01	10/17 -	3/12- 11/6/01	11/6/01 11/4/02	3/27/02 5/14/02	Mean	Std. Dev.	
PAS1	0.45	0.33	0.46		0.33		0.25	0.36	0.09	
PAS2		0.75	0.48		0.83		0.70	0.69	0.15	
PAS3		0.87	0.52		0.96		1.99	1.08	0.63	
NB001-S	0.72	0.41	0.26		0.33		0.19	0.38	0.21	
NB001-D	0.60	0.14	0.36		0.29		0.12	0.30	0.20	
NB003		0.30	0.00		0.24		0.12	0.16	0.13	
AK1-S		0.38	0.39				0.31	0.36	0.04	
AK1-D				0.43	0.31		0.29	0.34	0.08	
PA-S		0.35	0.37		0.19		0.15	0.27	0.11	
PA-D				0.20	0.22		0.17	0.20	0.02	
HAC1	0.48	0.28	0.22		0.25		0.16	0.28	0.12	
HAC2		0.33	0.41		0.52		0.42	0.42	0.08	
HAC3		0.48	0.84		0.36		0.61	0.57	0.21	
KVK001		0.21	0.22		0.24		0.12	0.20	0.05	
RAR1-S			0.44		0.22		0.26	0.11	0.26	0.14
RAR2			0.61		0.60		0.29	0.56	0.51	0.15
RHWY1				1.11	0.62		0.41	1.35	0.87	0.43
ELIZ1				0.30	0.82		0.26	0.40	0.45	0.26



**Figure 66:** Mean  $\pm$  standard deviation dissolved Dieldrin concentration (ng/L) at each sampling station.

#### 5.7.4.4 Dissolved Total BHC

The Total BHC concentrations are calculated by adding the measured concentrations of the following compounds: alpha-BHC, beta-BHC and gamma-BHC (Lindane). Table 51 presents the dissolved Total BHC concentrations (ng/L) at all sampling stations during all sampling events, as well as the overall arithmetic mean and standard deviation of this data (also see Figure 67).

Over all sampling stations and surveys (n = 72 samples), the percentage of Total BHC (dissolved + suspended sediment fractions) that is in the dissolved phase ranges from 84.5 to 100%, with a mean  $\pm$  standard deviation of  $98.3 \pm 2.4\%$ , and a median of 98.9%. The mean percentage of dissolved Total BHC at the tributary stations ( $97.8 \pm 3.0\%$ ) did not differ from that at the estuary stations ( $98.8 \pm 1.2\%$ ).

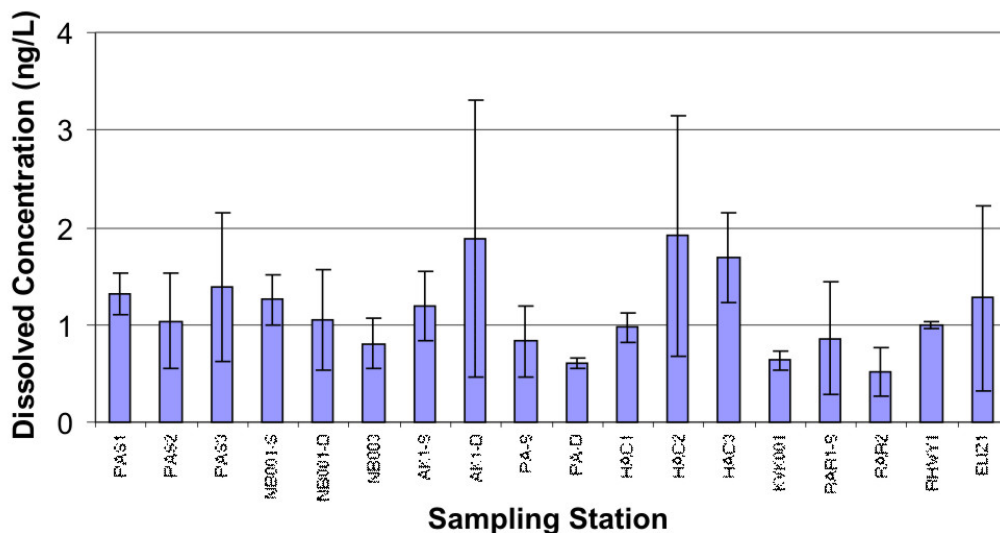
The highest mean concentrations ( $> 1.5$  ng/L) are measured in the mid/upper Hackensack River (Station HAC2 = 1.91 ng/L and Station HAC3 = 1.69 ng/L) and in the upper Arthur Kill (Station AK1-D = 1.88 ng/L).

The coefficient of variation (ratio of the standard deviation over the arithmetic mean, an indicator of data variability) of the dissolved Total BHC data ranged between 0.040 and 0.758. The coefficient of variation was greater than 0.60 at Stations HAC2, RAR1-S, AK1-D, and ELIZ1.

**Table 51: Dissolved Total BHC Concentration (ng/L)**

	6/20- 22/00	12/13- 15/00	3/13- 15/01	4/12/01	4/25/01	5/15/01	5/24/01	10/17- 19/01	10/3/01	11/6/01	11/4/02	3/27/02	5/14/02	Mean	Std. Dev.
PAS1	1.07	1.21	1.22					1.55			1.53			1.32	0.22
PAS2		0.65	0.61					1.62			1.26			1.03	0.49
PAS3		1.22	0.58					1.30			2.42			1.38	0.76
NB001-S	1.50	1.55	1.17					1.15			0.94			1.26	0.31
NB001-D	1.24	0.55	1.79					1.11			0.56			1.05	0.52
NB003		1.08	1.08					0.79			0.56			0.87	0.25
AK1-S		1.49	1.28										0.80	1.19	0.35
AK1-D					3.52		1.16			0.96				1.88	1.43
PA-S		1.28	0.97					0.51			0.56			0.83	0.37
PA-D					0.56		0.66				0.59			0.61	0.05
HAC1	1.13	0.84	1.00					1.08			0.80			0.97	0.15
HAC2		1.06	1.33					3.75			1.52			1.91	1.24
HAC3		1.22	1.42					1.85			2.27			1.69	0.47
KVK001		0.62	0.77					0.56			0.58			0.63	0.09
RAR1-S				0.80		0.61			1.68			0.34		0.86	0.58
RAR2				0.31		0.75			0.70			0.27		0.51	0.25
RHWY1					1.02		0.95			1.04			0.97	0.99	0.04
ELIZ1					0.78		2.71			0.87			0.75	1.28	0.96

**Total BHC in Dissolved Phase**



**Figure 67: Mean ± standard deviation dissolved Total BHC concentration (ng/L) at every sampling station.**



### 5.7.5 Suspended Sediment Total Pesticides Concentrations

Table 52 shows the suspended sediment Total pesticides concentrations (ng/g) at all sampling stations during all sampling events, as well as the overall arithmetic mean and standard deviation of this data (also see Figure 68).

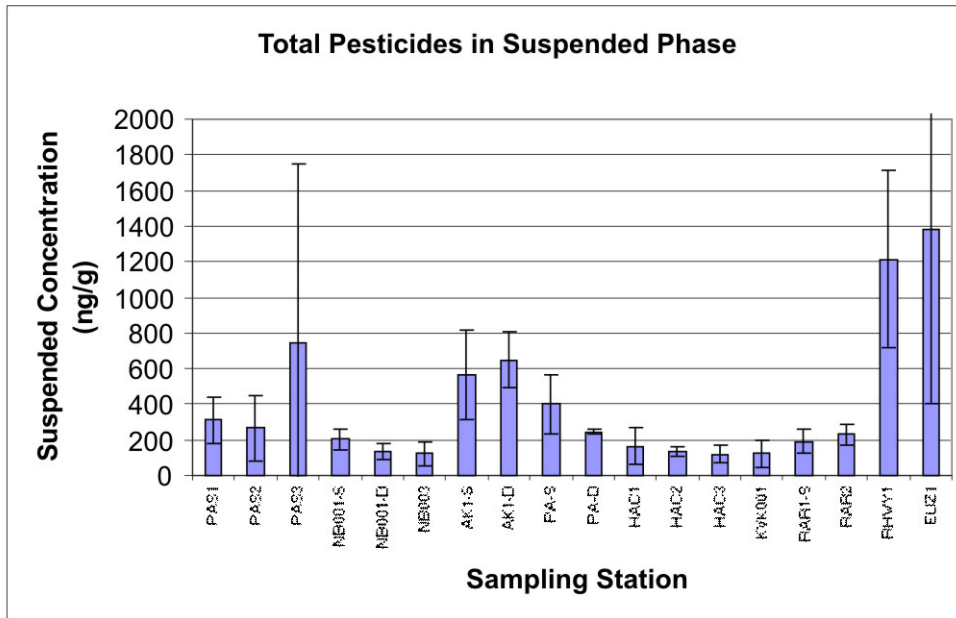
The highest mean concentrations (> 1,200 ng/g) are measured in the Rahway (1,213 ng/g) and Elizabeth (1,384 ng/g) Rivers, with intermediate levels in the upper Passaic River (Station PAS3 = 743 ng/g) and Arthur Kill (565 to 950 ng/g). Lower mean levels (120 to 315 ng/g) are found at all of the other stations. As seen in Figure 68, the mean Total pesticides concentration in the suspended phase varies significantly in the study area.

The coefficient of variation of the suspended sediment Total pesticides data ranged between 0.055 and 1.354. The coefficient of variation was greater than 1.35 at Station PAS3, and was less than 0.71 at the remaining stations.

Over all sampling stations, there was no correlation ( $r = -0.007$ ) between suspended sediment Total pesticides (ng/g sed) and SS (mg/L).

**Table 52:** Suspended Sediment Total Pesticides Concentration (ng/g)

	6/20- 22/00	12/13- 15/00	3/13- 15/01	4/12/01	4/25/01	5/15/01	10/17- 5/24/01	11/9/01	3/12- 11/6/01	11/4/02	3/27/02	5/14/02	Mean	Std. Dev.
PAS1	372	233	495				156		307				313	130
PAS2		90	457				253						267	184
PAS3		2253	195				251		275				743	1007
NB001-S	266	216	225				108		209				205	58
NB001-D	206	87	124				106		138				132	46
NB003		213	120				64		91				122	65
AK1-S		806	303								586		565	252
AK1-D					735		466		750				650	160
PA-S		326	584				486		202				400	169
PA-D					252		229		250				244	13
HAC1	203	21	290				103		207				165	104
HAC2		98	136				129		169				133	29
HAC3		84	128				185		82				120	48
KVK001		220	138				39		96				123	76
RAR1-S				197		284		152			132		191	67
RAR2				279		239		169					229	56
RHWY1					1202		513		1608			1529	1213	499
ELIZ1					2548		1827		419			743	1384	982



**Figure 68:** Mean  $\pm$  standard deviation suspended sediment phase Total pesticides concentration (ng/g) at every sampling station.

#### 5.7.5.1 Suspended Sediment Total DDT

Table 53 presents the suspended sediment Total DDT concentrations (ng/g) at all sampling stations during all sampling events, as well as the overall arithmetic mean and standard deviation of this data (also see Figure 69).

The highest mean concentrations ( $> 725$  ng/g) are measured in the Rahway (936 ng/g) and Elizabeth (734 ng/g) Rivers, with intermediate levels in the upper Passaic River (Station PAS3 = 382 ng/g) and Arthur Kill (302 to 546 ng/g). Lower mean levels (50 to 210 ng/g) were found at all of the other stations. Comparing the mean suspended sediment Total pesticide and Total DDT levels at each sampling station, on average Total DDT accounted for  $67.1 \pm 12.5\%$  of the suspended sediment Total pesticides.

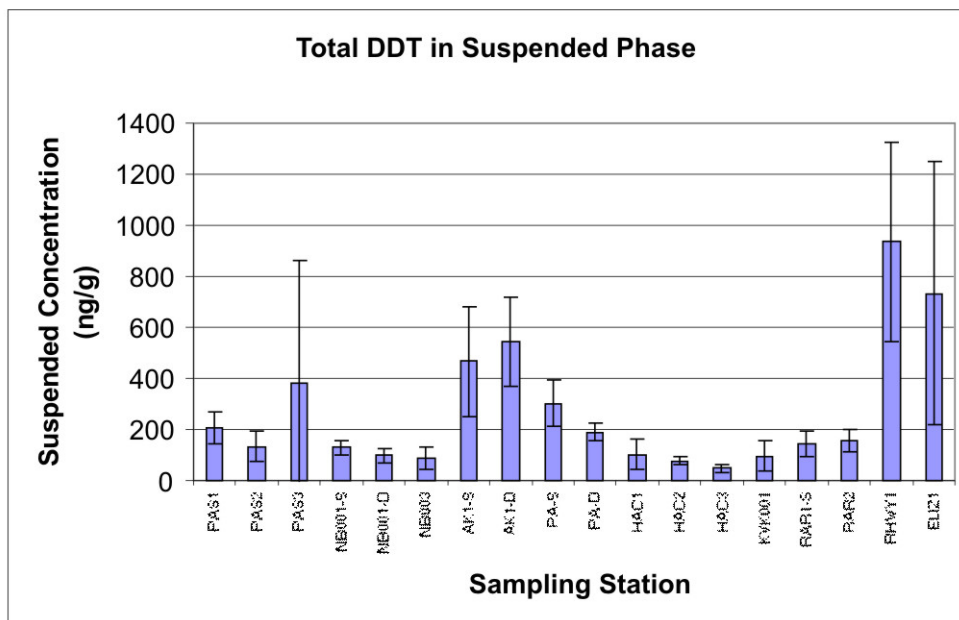
The coefficient of variation of the suspended sediment Total DDT data ranged between 0.222 and 1.452. The coefficient of variation was greater than 0.8 at Stations PAS3 and ELIZ, and was less than 0.7 at the remaining stations.

Over all sampling stations, there was no correlation ( $r = -0.008$ ) between suspended sediment Total DDTs (ng/g sed) and SS (mg/L). However, there was a very strong correlation between

suspended sediment Total DDTs and Total pesticides (Total DDT [ng/g] = 0.61\*Total Pesticides [ng/g] + 18.5; r = 0.943).

**Table 53:** Suspended Sediment Total DDT Concentrations (ng/g)

	6/20- 22/00	12/13- 15/00	3/13- 15/01	4/12/01	4/25/01	5/15/01	5/24/01	10/17- 11/9/01	10/3/01	11/6/01	3/12- 11/4/02	3/27/02	5/14/02	Mean	Std. Dev.
PAS1	248	169	297					120			199			206	69
PAS2			52	195				151						133	73
PAS3			1214	72				133			110			382	555
NB001-S	131	153	117					85			155			128	29
NB001-D	152	67	82					84			102			97	33
NB003		160	73					51			72			89	49
AK1-S		695	181										522	466	261
AK1-D					638			301			698			546	214
PA-S		271	425					330			180			302	103
PA-D					203			142			223			189	42
HAC1	87	12	189					81			145			103	68
HAC2		55	70					83			96			76	17
HAC3		34	52					75			34			49	19
KVK001		192	87					32			74			96	68
RAR1-S				130		229			113			105		144	57
RAR2				212		142			112					155	51
RHWY1					819		364			1411			1150	936	452
ELIZ1					1614		553			361			407	734	593

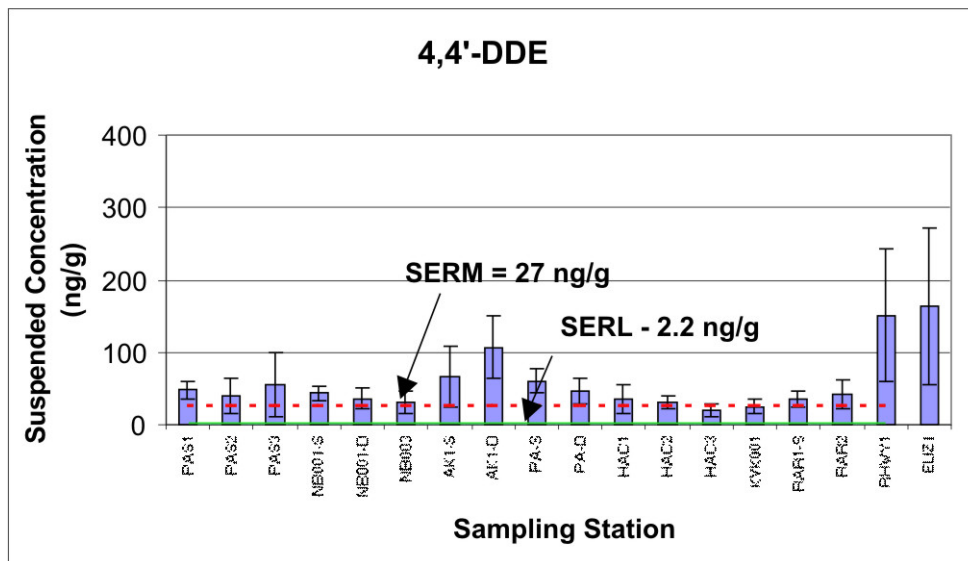


**Figure 69:** Mean ± standard deviation suspended sediment Total DDT concentration (ng/g) at every sampling station.

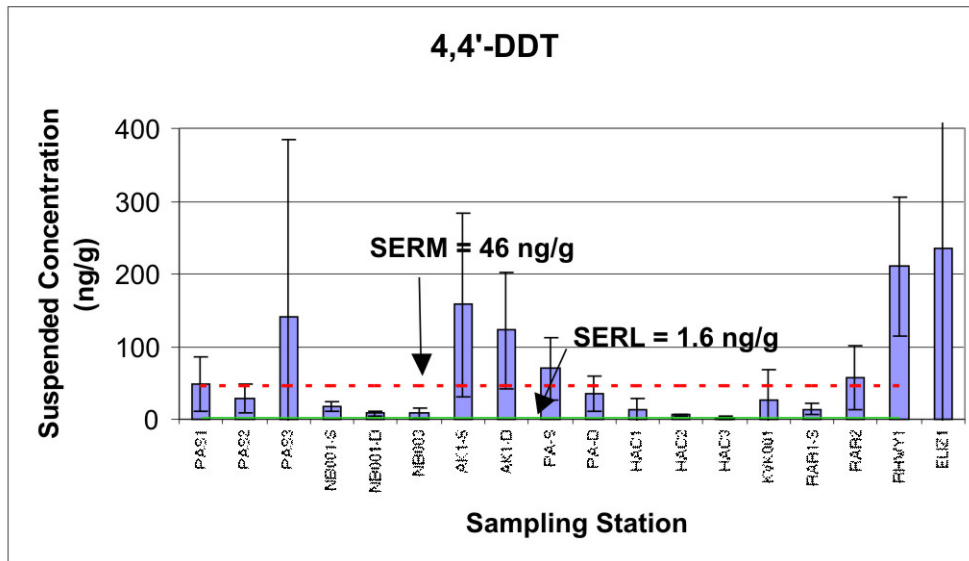
Figures 70 and 71 show the mean suspended sediment concentrations of the individual compounds 4,4'-DDE and 4,4'-DDT, respectively.

The mean 4,4'-DDE concentration exceeds the Sediment Effects Range Low (Long et al., 1995) guideline value (2.2 ng/g) at all sampling stations, and exceeds the Sediment Effects Range Median value (27 ng/g) at every station except HAC3 and KVK. The Elizabeth and Rahway River mean 4,4'-DDE concentrations are elevated (>150 ng/g), with AK1-D also greater than 100 ng/g. The mean 4,4'-DDE concentrations measured at all other stations are less than 67 ng/g.

The mean 4,4'-DDT concentration in the suspended sediment phase exceeds the Sediment Effects Range Low guideline value (1.6 ng/g) at all sampling stations, and exceeds the Sediment Effects Range Median value (46 ng/g) at 8 of the 18 sampling stations (Passaic River, Rahway River, Elizabeth River, Raritan River, Arthur Kill, and Perth Amboy). The Elizabeth, Rahway, and Perth Amboy (PA-S) mean 4,4'-DDT concentrations are elevated (> 185 ng/g), with the upper Arthur Kill (AK1-S/D) and upper Passaic River (PAS3) stations exceeding 120 ng/g. The mean 4,4'-DDT concentration at all other stations, except RAR2, is less than 50 ng/g. As seen in Figure 71, the surface water samples collected at Stations NB1, AK1, and PA tend to have higher mean concentrations than the samples collected at depth.



**Figure 70:** Mean ± standard deviation suspended sediment 4,4'- DDE concentration (ng/g) at every sampling station.



**Figure71:** Mean ± standard deviation suspended sediment 4,4'- DDE concentration (ng/g) at every sampling station.

#### 5.7.5.2 Suspended Sediment Total Chlordane

Table 54 presents the Total Chlordane concentrations in the suspended sediment phase (ng/g) at all sampling stations during all sampling events, as well as the overall arithmetic mean and standard deviation of this data (also see Figure 72).

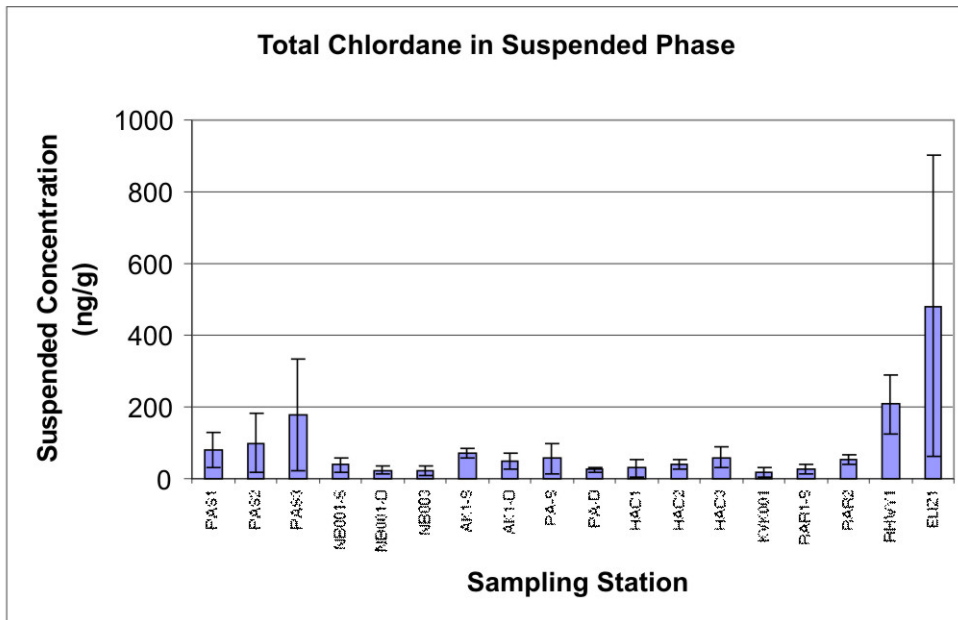
The highest mean concentration is measured in the Elizabeth River (482 ng/g). The mean Total Chlordane concentrations in the Rahway River and upper Passaic River (Station PAS3) are greater than 175 ng/g. Mean concentrations at all of the other stations are less than 100 ng/g). Comparing the mean suspended sediment Total pesticide and Total Chlordane levels at each sampling station, on average Total Chlordane accounted for  $21.6 \pm 10.6\%$  of the Total suspended sediment pesticides.

The coefficient of variation of the suspended sediment Total Chlordane data ranged between 0.211 and 0.874. The coefficient of variation was greater than 0.7 at Stations PAS2, PAS3, HAC1, ELIZ, and PA-S.

Over all sampling stations, there was no correlation ( $r = 0.067$ ) between suspended sediment Total Chlordane (ng/g sed) and SS (mg/L). However, there was a strong correlation between suspended sediment Total Chlordane and Total pesticides (Total Chlordane [ng/g] =  $0.24 \times$  Total Pesticides [ng/g] - 8.7;  $r = 0.815$ ). There was a moderate correlation between suspended sediment Total Chlordane and Total DDTs (Total Chlordane [ng/g] =  $0.28 \times$  Total DDTs [ng/g] + 15.7;  $r = 0.606$ ).

**Table 54:** Suspended Sediment Total Chlordane Concentration (ng/g)

	6/20- 22/00	12/13- 15/01	3/13- 15/01	4/12/01	4/25/01	5/15/01	5/24/01	10/17- 11/19/01	10/3/01	11/6/01	3/12- 11/4/02	3/27/02	5/14/02	Mean	Std. Dev.
PAS1	100	42	144					24			87			79	48
PAS2		24	187					84						98	82
PAS3		409	79					97			130			179	155
NB001-S	32	38	72					15			39			39	20
NB001-D	36	13	28					15			28			24	10
NB003		33	34					9			15			23	13
AK1-S		82	77										54	71	15
AK1-D					47			71			26			48	22
PA-S		38	115					59			15			57	43
PA-D					33			23			19			25	7
HAC1	22	6	64					14			47			31	24
HAC2		26	42					31			56			38	13
HAC3		36	73					92			38			60	27
KVK001		18	37					5			18			19	13
RAR1-S				37		37			13			20		27	12
RAR2				43		69			46					53	15
RHWY1					254		132			143			300	207	83
ELIZ1					616		1003			38			270	482	421



**Figure 72:** Mean  $\pm$  standard deviation suspended sediment Total Chlordane concentration (ng/g) at every sampling station.

### 5.7.5.3 Suspended Sediment Dieldrin

Table 55 presents the Dieldrin concentrations (ng/g) in the suspended sediment phase at all sampling stations during all sampling events, as well as the overall arithmetic mean and standard deviation of this data (also see Figure 73).

The highest mean concentration was measured in the upper Passaic River (Station PAS3 = 94 ng/g), with elevated concentrations (> 30 ng/g) in the Rahway and Elizabeth Rivers. However, the Station PAS3 mean is skewed by the large December 2000 value of 323 ng/g; the median value at Station PAS3 is only 23 ng/g. Likewise, the Rahway and Elizabeth River mean values are elevated due to high values in the April 2001 samples. Mean suspended sediment Dieldrin concentrations at all other stations are less than 20 ng/g. Comparing the mean suspended sediment Total pesticide and Dieldrin levels at each sampling station, on average Dieldrin accounted for  $3.9 \pm 2.8\%$  of the Total suspended sediment pesticides.

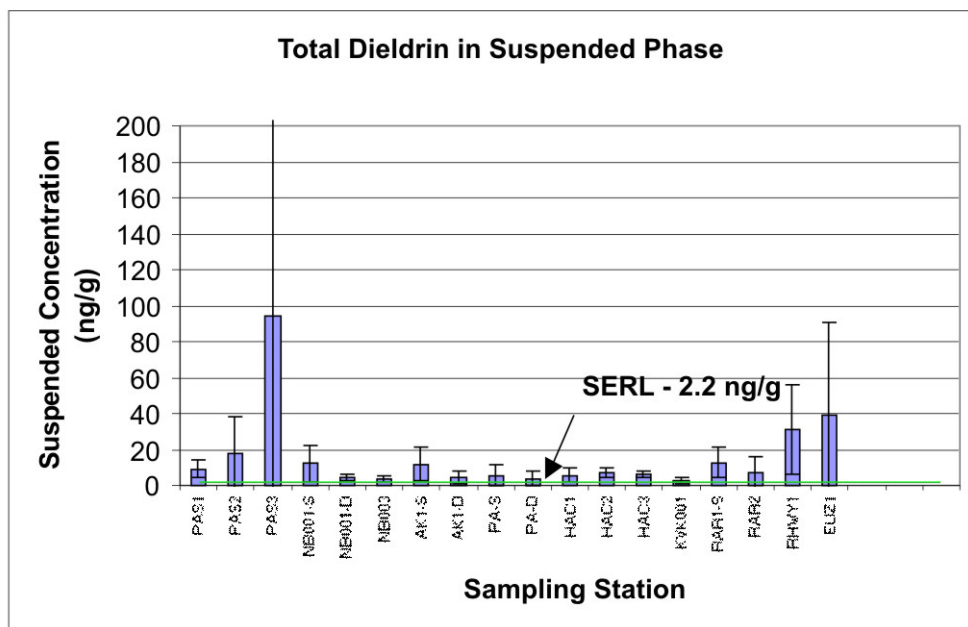
The coefficient of variation of the suspended sediment Dieldrin data ranged between 0.308 and 1.615. The coefficient of variation was greater than 1.0 at Stations PAS2, PAS3, ELIZ, RAR2, and PA-S.

Over all sampling stations, there was no correlation ( $r = -0.112$ ) between suspended sediment Dieldrin (ng/g sed) and SS (mg/L). However, there was a moderate correlation between suspended sediment Dieldrin and Total pesticides (Dieldrin [ng/g] =  $0.06 * \text{Total Pesticides [ng/g]} - 6.4$ ;  $r = 0.680$ ). There was also a moderate correlation between suspended sediment Dieldrin and Total DDTs ( $r = 0.590$ ) and, less so, with Total Chlordane ( $r = 0.458$ ).

The mean Dieldrin concentration in the suspended sediment phase exceed the Sediment Effects Range Low guidance value (2.2 ng/g; Long et al., 1995) at all sampling stations.

**Table 55: Suspended Sediment Dieldrin Concentration (ng/g)**

	6/20- 22/00	12/13- 15/00	3/13- 15/01	4/12/01	4/25/01	5/15/01	10/17- 5/24/01	11/9/01	10/3/01	11/6/01	3/12- 14/02	3/27/02	5/14/02	Mean	Std. Dev.	
PAS1	11	5.9	16						3.5		9.2			9.1	4.7	
PAS2		5.8	41						7.5					18	20	
PAS3		323	23						9.2		22			94	152	
NB001-S	29	7.2	14						2.0		9.9			12	10	
NB001-D	7.0	2.3	5.0						2.5		4.1			4.2	1.9	
NB003		5.3	4.7						1.4		2.2			3.4	1.9	
AK1-S		8.7	22										5.0	12	9.0	
AK1-D					8.3		1.3				3.2			4.3	3.7	
PA-S		2.9	14						2.1		3.2			5.5	5.7	
PA-D					8.1		0.4				3.4			4.0	3.9	
HAC1	10	0.9	8.7						2.0			6.2		5.6	4.1	
HAC2		5.3	10						5.1		9.2			7.4	2.6	
HAC3		5.8							8.7		5.0			6.5	2.0	
KVK001		1.9	4.5						0.7		2.7			2.4	1.6	
RAR1-S				14		9.3				24			3.4	13	8.7	
RAR2				17		0.0				5.6				7.5	8.7	
RHWY1					62		0.8				32			29	31	25
ELIZ1					115		13				5.6			24	39	51



**Figure 73: Mean ± standard deviation suspended sediment Dieldrin concentration (ng/g) at every sampling station.**



### 5.7.6 Wet vs. Dry Events

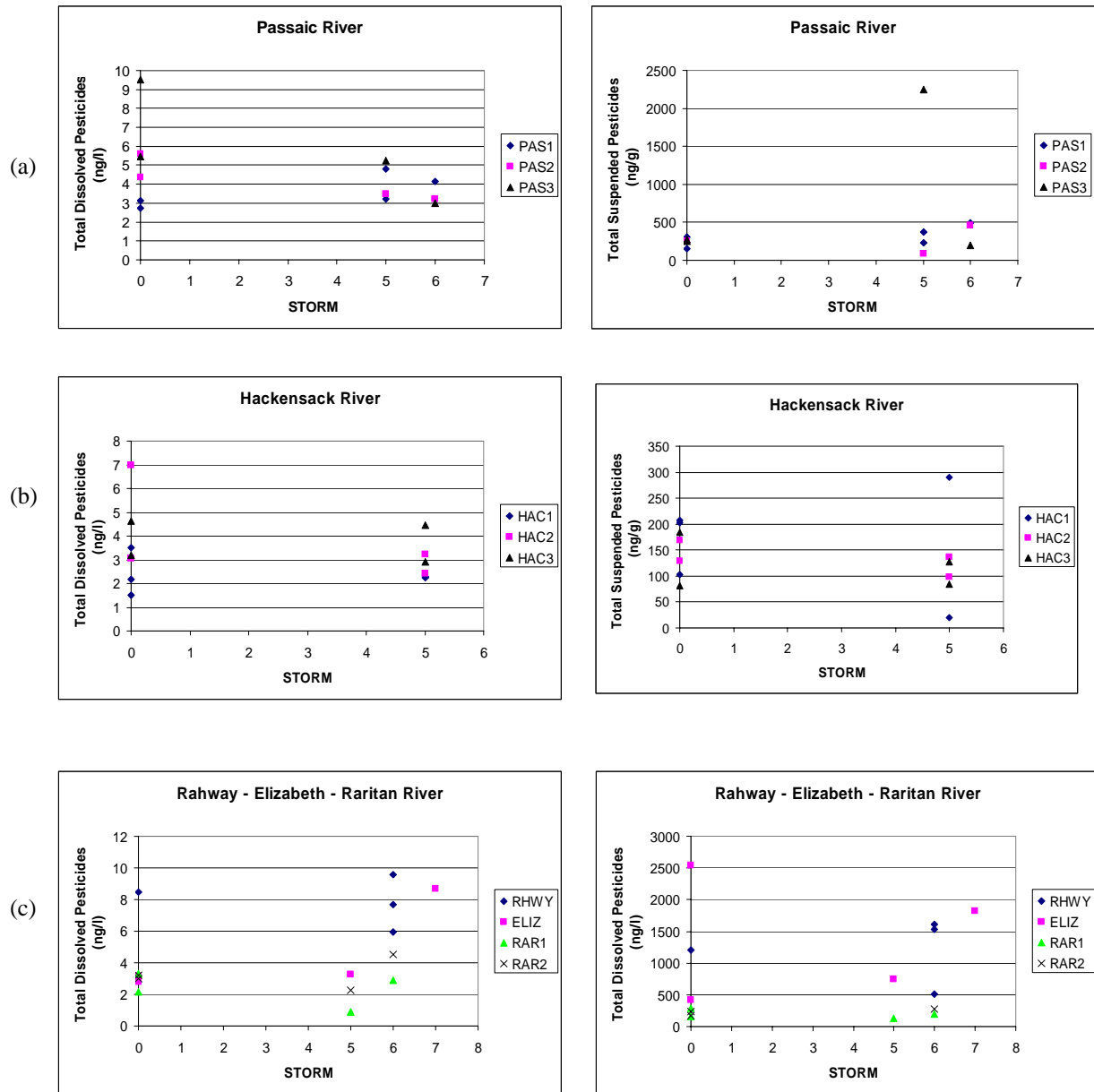
Figure 74(a-c) shows a comparison between dry and wet weather events for Total pesticides concentrations in both the dissolved and the suspended sediment phase at all of the tributary sampling stations.

Suspended sediment total pesticide levels in the Passaic River do not appear to consistently vary with river flow conditions. Stations PAS2 and PAS3 tend to have lower dissolved total pesticides concentrations during wet events, suggesting a dilution effect. Dissolved concentrations tend to be higher at Station PAS1 during wet events, potentially indicative of a stormwater source of pesticides.

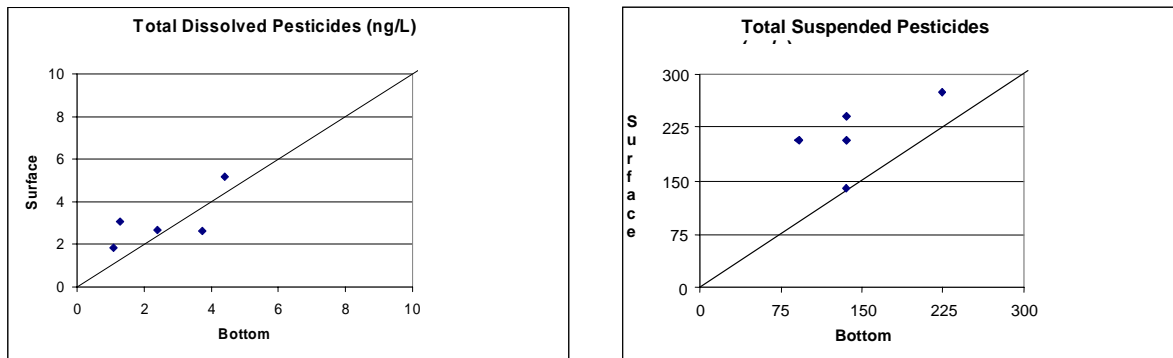
Neither dissolved nor suspended sediment total pesticide levels in the Hackensack, Elizabeth, Rahway, and Raritan Rivers appear to consistently vary with river flow conditions.

### 5.7.7 Newark Bay: Surface vs. Bottom Concentrations

Figure 75 shows both surface (5ft below the surface) and bottom (5ft above the bottom) total pesticides concentrations at the Newark Bay Station NB1-S/D. There was a tendency for both total dissolved pesticides and suspended sediment total pesticides to be greater at the surface.



**Figure 74:** Dissolved and suspended sediment Total pesticides concentrations – Wet vs. Dry Events. (a) Passaic River, (b) Hackensack River, (c) Rahway, Elizabeth, and Raritan Rivers.



**Figure 75:** Surface vs. Bottom dissolved and suspended sediment Total pesticides concentrations at Newark Bay Station NB1-S/D.

### 5.7.8 Pesticides Conclusions

- (1) Heptachlor was impacted by blank contamination in 64 of the 69 dissolved fraction samples. Hexachlorobenzene, methoxychlor, and 2,4'-DDT were impacted by blank contamination in approximately 40-50% of the dissolved samples. The suspended sediment fraction samples were not significantly impacted by blank contamination.
- (2) Mean concentrations of the various dissolved pesticides were elevated at particular sampling locations in the harbor, indicative of potential sources:
  - Rahway River – Total pesticides, Total DDTs, Total Chlordane, and Dieldrin
  - Upper Arthur Kill (Station AK1-D) – Total Pesticides, Total DDTs (also at Station AK1-S), and Total BHC
  - mid/upper Passaic River (Stations PAS2/3) – Total Chlordane, and Dieldrin
  - Elizabeth River – Total Chlordane
  - mid/upper Hackensack River (Stations HAC2/3) – Total BHC

Concentrations were lower and similar at the remaining sampling locations.

Along the Passaic, Hackensack, and Raritan Rivers, there was a tendency for dissolved pesticide concentrations to increase in the upstream direction, potentially indicative of upstream sources (with dilution occurring downstream).

- (3) The Rahway and Elizabeth Rivers had the highest mean suspended sediment Total pesticides, Total DDTs (and 4,4'-DDE and 4,4'-DDT), and Total Chlordane concentrations. Intermediate levels of these compounds were found in the upper Passaic River (Station PAS3) and Arthur Kill (Stations AK1-S/D and PA-S). The highest mean suspended

sediment Dieldrin concentration was measured in the upper Passaic River (Station PAS3), with elevated concentrations in the Rahway and Elizabeth Rivers (although all of these Dieldrin means may be biased high due to one-time sample results).

- (4) The New Jersey Saline Human Health Water Quality Criteria (WQC) for Total 4,4'-DDD (suspended + dissolved fractions; 0.31 ng/L) was exceeded by 91% of the samples collected as part of this study. The Human Health WQC for Total 4,4'-DDE and Total 4,4'-DDT (0.22 ng/L) was exceeded by 93% and 47%, respectively, of the samples. The New Jersey Saline Aquatic Chronic WQC for Total 4,4'-DDT (1.0 ng/L) was exceeded by 21% of the samples, including all/most of the samples in the lower Passaic River, Elizabeth River, Rahway River, and upper Arthur Kill. The mean 4,4'-DDE and 4,4'-DDT concentrations exceed the Sediment Effects Range Low guidance values at all sampling stations. The mean 4,4'-DDE concentrations exceed the Sediment Effects Range Median value at every station except HAC3 and KVK. The mean 4,4'-DDT concentration exceeds the Sediment Effects Range Median guidance at 8 of the 18 sampling stations. These exceedances of the New Jersey WQC and Long et al. (1995) guidance values indicate that DDT and its metabolites may have significant adverse impacts on overall water quality in the study area.
- (5) The New Jersey Saline Human Health Water Quality Criteria (WQC) for Total Dieldrin (suspended + dissolved fractions; 0.054 ng/L) was exceeded by every sample collected as part of this study (except for one (1) sample each at Stations NB1-D and NB3). The New Jersey Saline Aquatic Chronic WQC for Total Dieldrin (1.9 ng/L) was exceeded by only two (2) samples (Station PAS3 March 2003 and Rahway River May 2002). (Note: the New Jersey Saline Human Health Water Quality Criteria (WQC) for Total Aldrin - which degrades to Dieldrin [0.050 ng/L] - was exceeded in only two (2) samples [at Stations PAS3 and RHWY1]). The mean Dieldrin concentrations exceed the Sediment Effects Range Low guidance values at all sampling stations. These exceedances of the New Jersey WQC and Long et al. (1995) guidance values indicate that Dieldrin may have significant adverse impacts on overall water quality in the study area.
- (6) The New Jersey Saline Human Health Water Quality Criteria (WQC) for Total Chlordane (suspended + dissolved fractions; 0.11 ng/L) was exceeded by every sample collected as part of this study. The New Jersey Saline Aquatic Chronic WQC for Total Chlordane (4.0 ng/L) was exceeded by the mean concentrations in the Rahway and Elizabeth Rivers, and by individual samples at Stations PAS1 and PAS3. These exceedances of the New Jersey WQC indicate that Chlordane may have significant adverse impacts on overall water quality in the study area.
- (7) The New Jersey Saline Human Health Water Quality Criteria (WQC) for Total Heptachlor epoxide (suspended + dissolved fractions; 0.039 ng/L) was exceeded by every tributary sample, and 72% of the estuary samples, collected as part of this study. These exceedances of the New Jersey WQC indicate that Heptachlor epoxide may have significant adverse impacts on overall water quality in the study area.
- (8) The New Jersey Saline Human Health or Aquatic Chronic Water Quality Criteria (WQC) for the following pesticides were not exceeded by any sample collected as part of this study:

- alpha-, beta-, and gamma-BHCs
- alpha- and beta-endosulfan and endosulfan sulfate
- endrin and endrin aldehyde
- methoxychlor
- mirex
- heptachlor (except for two [2] samples in the Elizabeth River, and one [1] sample each in the Rahway River and at Station PA-S).

## 6 Summary and Conclusions

**Sampling Methodology:** The major advantage of the SIT-TOPS is its ability to process large volumes of water. Since it can process water at a much greater rate through the filters than through the XAD resin columns, significant amounts of suspended solids may be captured even in waters with low SS. A 0.5  $\mu\text{m}$  Cartridge GFF (C-GFF), followed by a 0.7 $\mu\text{m}$  142mm AE in-line flat filter, is the optimal solution to minimize the amount of SS passing into the XAD columns, and thus reducing the error in the measured “dissolved concentrations”.

**Metals:** Mean dissolved and Total Cd concentrations varied little at all of the sampling stations, with the lowest concentrations in the upper Raritan River (Station RAR2). In contrast, mean dissolved and Total Hg at each of the sampling stations varied by a factor of 20 throughout the harbor; mean dissolved Pb varied by a factor of 9 and mean Total Pb varied by a factor of 5. Mean Total Hg and Pb concentrations were highest in the Hackensack, Rahway, Passaic, and Elizabeth (Pb only) Rivers.

Dissolved metals concentrations did not vary with river flow (i.e. wet/dry weather conditions) at any of the sampling stations. Total and suspended sediment metals concentrations also did not vary with river flow, except in the Rahway River and for Cd in the Elizabeth River, where they tended to be greater during wet weather events. The increases in the concentrations of these metals during wet weather in the Rahway River are indicative of potential stormwater/runoff sources.

Most of the Pb was found in the suspended sediment fraction (mean = 82.6%), and there was a strong correlation between Total Pb (ng/L) and suspended sediment (mg/L). In contrast, while most of the Hg was found in the suspended sediment fraction (mean = 93.5%), there was only a moderate correlation between Total Hg and suspended sediment.

The New Jersey Saline Water Quality Criteria (WQC) for Cd and Pb were not exceeded by any sample collected as part of this study. The NJ Saline Aquatic Chronic WQC for Hg was not exceeded by any sample. However, the NJ Saline Human Health WQC for Total Hg (51 ng/L) was exceeded by the mean concentration in the lower Passaic River, mid-upper Hackensack River, and the Rahway River, and by individual samples at other locations.

**PCBs:** The NJ Saline Human Health WQC for Total PCBs (64 pg/L) was exceeded by every sample collected as part of this study. The NJ Saline Aquatic Chronic WQC (30 ng/L) was exceeded by the mean concentration in the Rahway River, and by individual samples at other locations. These widespread exceedances of the WQC indicate that PCBs may have significant adverse impacts on water quality in the study area.

There is little variation in the mean Total Dissolved PCB concentrations throughout the study area. In contrast, mean Total Suspended Sediment PCB concentrations were highest in the

Passaic, mid/upper Hackensack, Rahway, and Elizabeth Rivers, with lower concentrations at the Raritan River and estuarine stations.

“Average” PCB homolog distribution patterns varied among the dissolved and suspended sediment fraction samples, with 70% of the dissolved mass concentrated in the Tri- and Tetra-homologs and 51% of the suspended sediment mass in the Tetra- and Penta- groups. For any PCB homolog group, there was little difference in the mean percentage composition among the (a) Passaic River, Hackensack River, and Newark Bay sampling stations, and (b) Newark Bay, Arthur Kill, and Kill van Kull sampling stations. However, there do appear to be some trends that may be indicative of potential PCB sources and/or suspended sediment and contaminant transport in the harbor.

In contrast, the PCB homolog distribution patterns in the Rahway, Elizabeth, and Raritan Rivers, and the upper Arthur Kill, vary among the surveys, particularly for the suspended sediment fraction data. PCB homolog distribution patterns in both the dissolved and suspended sediment phases show that the Elizabeth and Rahway Rivers tend to shift towards the higher (Penta-through Hepta-) homolog groups compared with the Passaic and Hackensack Rivers. This trend may also be indicative of different PCB sources.

**Dioxins/Furans:** The NJ Saline Human Health WQC for 2,3,7,8-TCDD (0.0051 pg/L) was exceeded by all samples collected (except for a few samples where it was not detected).

Total PCDD/F concentrations were largely determined by the tPCDD concentrations. Mean Total Dioxin/Furan (tPCDD/F) concentrations (pg/L) were highest in the Rahway and Elizabeth Rivers. The highest mean Total PCDD/F concentrations (pg/g sed) were found in the Elizabeth River and in the upper Raritan River Station RAR2 (due to high OCDD levels).

The highest concentrations of 2,3,7,8-TCDD (as well as Total TEQ toxicity and the %TEQ resulting from 2,3,7,8-TCDD) were found in the Passaic and Hackensack Rivers, and in upper Newark Bay. The 2,3,7,8-TCDD concentration distribution pattern among the sampling sites in Newark Bay and the Passaic and Hackensack Rivers points to the existence of a source(s) along the Passaic River. The major source of this 2,3,7,8-TCDD has been attributed to the Diamond Alkali (Lister Avenue, Newark) site located on the banks of the lower Passaic River.

Based on tPCDD/F and 2,3,7,8-TCDD concentrations and tPCDD/F TEQs, it appears that the harbor estuary can be separated into five sub-areas, as follows:

- Passaic River, Upper Newark Bay, and the Hackensack River: characterized by elevated levels of 2,3,7,8-TCDD (particularly in the lower Passaic River) and high tPCDD/F TEQs.
- Elizabeth River: characterized by elevated levels of tPCDD/Fs and 2,3,7,8-TCDD, resulting in a high mean tPCDD/F TEQ.
- Rahway River: characterized by very high levels of tPCDD/Fs and elevated levels of 2,3,7,8-TCDD. However, the mean tPCDD/F TEQ is not elevated.
- Raritan River: the upper Raritan River is characterized by elevated levels of tPCDD/Fs due to very high concentrations of OCDD. PCDD/F concentrations in the lower Raritan River are

similar to those in the lower Arthur Kill. 2,3,7,8-TCDD concentrations are low. Total PCDD/F TEQ at both Raritan River sites were among the lowest in the harbor.

- Arthur Kill, Kill Van Kull, and Lower Newark Bay: characterized by low to moderate levels of tPCDD/Fs and low levels of 2,3,7,8-TCDD. Total PCDD/F TEQ are low at these sites.

The mean furan congener distribution pattern is more variable among the sites than the mean dioxin congener distribution pattern (except for 2,3,7,8-TCDD). Thus, for source identification purposes, 2,3,7,8-TCDD and the furans will be most useful. Analysis of the PCDD/F congener distribution patterns have identified potential sources of PCDD/Fs to NY-NJ Harbor associated with the following locations:

- Lower Passaic River (and upper Newark Bay and lower Hackensack River): 2,3,7,8-TCDD.
- Lower Hackensack River: PCDFs, particularly OCDF, 1,2,3,4,6,7,8-HpCDF, and 1,2,3,4,7,8-HxCDF.
- Elizabeth River (2 different sources): tetra- through hexa- PCDD/Fs, including 2,3,7,8-TCDD.
- Upper Raritan River: OCDD.

**PAHs:** Some of the dissolved phase PAH target analytes were impacted by blank contamination to a substantial degree. Thus, the use of the data for these analytes, as well as the calculation of total PAH concentrations, is problematical.

The highest mean suspended sediment total PAH concentrations (> 20,000 ng/g sed) were measured in the Elizabeth River, at all three Passaic River stations, in the lower Hackensack River, in the Rahway River, and in the upper Arthur Kill.

The highest mean total PAH concentrations (> 1,300 ng/L; dissolved + suspended sediment fractions) were measured in the Rahway River, the Elizabeth River, the upper Hackensack River, and the mid-Passaic River. Even though >60% of the Total PAHs were found in the dissolved phase, there was a moderate correlation ( $r = 0.62$ ) between total PAHs (ng/L) and SS (mg/L).

Based on the concentration ratios of some of the target PAH analytes, it appears that combustion of petroleum and grass/wood/coal are the main sources of PAHs in NY-NJ Harbor.

The NJ Saline Human health WQC for benzo(a)pyrene (18 ng/L) was exceeded by the mean concentration all of the sampling locations except those in the Raritan River and lower Arthur Kill. The WQC for dibenz(a,h)anthracene (18 ng/L) was exceeded by the mean concentration in the Rahway River.

**Pesticides:** Mean concentrations of the various dissolved pesticides were elevated at particular sampling locations in the harbor, indicative of potential sources:

- Rahway River – Total pesticides, Total DDTs, Total Chlordane, and Dieldrin



- Upper Arthur Kill – Total Pesticides, Total DDTs, and Total BHC
- mid/upper Passaic River – Total Chlordane, and Dieldrin
- Elizabeth River – Total Chlordane
- mid/upper Hackensack River – Total BHC

Along the Passaic, Hackensack, and Raritan Rivers, there was a tendency for dissolved pesticide concentrations to increase in the upstream direction, potentially indicative of upstream sources (with dilution occurring downstream).

The Rahway and Elizabeth Rivers had the highest mean suspended sediment Total pesticides, Total DDTs (and 4,4'-DDE and 4,4'-DDT), and Total Chlordane concentrations. Intermediate levels of these compounds were found in the upper Passaic River (Station PAS3) and Arthur Kill (Stations AK1-S/D and PA-S). The highest mean suspended sediment Dieldrin concentration was measured in the upper Passaic River (Station PAS3), with elevated concentrations in the Rahway and Elizabeth Rivers (although all of these Dieldrin mean concentrations may be biased high due to one-time sample results).

- DDT & metabolites – The highest mean dissolved Total DDT concentrations were measured in the Rahway River and northern Arthur Kill. The highest mean suspended sediment Total DDT concentrations were measured in the Rahway and Elizabeth Rivers, with intermediate levels in the upper Passaic River and Arthur Kill. This is indicative of a major source of DDT in the upper Arthur Kill/Rahway/Elizabeth River area, with an additional source associated with the upper Passaic River.

The NJ Saline Human Health WQC for Total 4,4'-DDT (0.31 ng/L), 4,4'-DDE (0.22 ng/L), and 4,4'-DDT (0.22 ng/L) were exceeded by 91%, 93%, and 47%, respectively, of the samples collected as part of this study. The Saline Aquatic Chronic WQC for Total 4,4'-DDT (1.0 ng/L) was exceeded by 21% of the samples, including all/most of the samples in the lower Passaic River, Elizabeth River, Rahway River, and upper Arthur Kill.

- Total Chlordane – The NJ Saline Human Health WQC for Total Chlordane (0.11 ng/L) was exceeded by every sample collected as part of this study. The NJ Saline Aquatic Chronic WQC (4.0 ng/L) was exceeded by the mean concentration in the Rahway and Elizabeth Rivers, and by individual samples in the Passaic River. The highest mean dissolved Total Chlordane concentrations (> 1 ng/L) and suspended sediment concentrations (> 175 ng/g) were measured in the Rahway River, Elizabeth River, and in the mid/upper Passaic River.
- Dieldrin – The NJ Saline Human Health WQC for Dieldrin (0.054 ng/L) was exceeded by almost every sample collected as part of this study.

The highest mean dissolved Dieldrin concentrations were measured in the Rahway River and the mid/upper Passaic River. The highest mean suspended sediment concentration was measured in the upper Passaic River (Station PAS3 = 94.3 ng/g), with elevated concentrations (> 30 ng/g) in the Rahway and Elizabeth Rivers. However, these mean values are elevated due to high values in only one sample collected at these stations.

- Total BHC - On average 98% of the total BHC concentration in the water column is in the dissolved phase. The highest mean dissolved concentrations ( $> 1.5$  ng/L) were in the mid/upper Hackensack River (Station HAC2 = 1.91 ng/L and Station HAC3 = 1.69 ng/L) and in the upper Arthur Kill (Station AK1-D = 1.88 ng/L).

## **7 Participants**

- George P. Korfiatis (Principal Investigator and Project Chief)
- Richard I. Hires (Principal Investigator)
- Christos Christodoulatos (Co-Investigator)
- Nadia Dimou (Project Manager)
- Tsan Liang Su (Lab Project Manager)
- Mohamed Sidhoum (Field Project Manager)
- Bob Miskewitz (Field Coordinator)

## **8 Acknowledgments**

This work was funded, in part, by a grant from the Port Authority of NY-NJ, by way of the NJ Office of Maritime Resources (NJDOT) and the NJ Department of Environmental Protection.

## 9 Literature Cited

- Budzinski, H., I. Jones, J. Bellocq, C. Pierard, and P. Garrigues 1997. Evaluation of sediment contamination by polycyclic aromatic hydrocarbons in the Gironde estuary. *Mar. Chem.* 58:86-97.
- Chant, R.J. 2006. Hydrodynamics of the Newark Bay/Kills System: The New Jersey Toxics Reduction Workplan for New York-New Jersey Harbor – Study I-E. April 2006, 66 pp.
- Cleverly D., J. Schaum, G. Schweer, J. Becker, and D. Winters, 1997. The congener profiles of anthropogenic sources of chlorinated dibenzo-p-Dioxins and dchlorinated Dibenzofurans in the United States. *Organohalogen Compounds* 32:430-435.
- Gschwend, P. M., and R.A.Hites 1981. Fluxes of polycyclic aromatic hydrocarbons to marine and lacustrine sediments in the northeastern United States. *Geochim. Cosmochim. Acta* 45:2359-2367.
- Hagenmaier, H., C. Linding, and J. She 1994. Correlation of environmental occurrence of polychlorinated dibenzo-p-Dioxins and Dibenzofurans with possible sources. *Chemosphere* 29(9-11):2163-2174.
- Huntley S. L., H. Carlson-Lynch, G. W. Johnson, D. J. Paustenbach, and B. L. Finley 1998. Identification of historical PCDD/F Sources in Newark Bay Estuary subsurface sediments using polytopic vector analysis and radioisotope dating techniques. *Chemosphere* 36(6):1167-1185.
- Long, E.R., D.D. MacDonald, S.L. Smith, and F.D. Calder 1995. Incidence of adverse biological effects within ranges of chemical concentrations in marine and estuarine sediments. *Environmental Management* 19(1):82-97.
- New Jersey Department of Environmental Protection, 2003. New Jersey Toxics Reduction Workplan, Volume II – Quality Assurance Project Plan, Version 2.2 – February 2003 (final draft).
- New Jersey Department of Environmental Protection, 2001a. New Jersey Toxics Reduction Workplan, Volume I, revised/Version 2 – February 2, 2001.
- New Jersey Department of Environmental Protection, 2001b. Stevens Institute of Technology Project Plan, Quality Assurance Plan, and Standard Operating Procedures for New Jersey Toxics Reduction Workplan for NY-NJ Harbor Study I-D: Ambient Monitoring Within Major and Minor Tributaries, Version 1.1, April 20, 2001.
- New Jersey Department of Environmental Protection, 2001c. Stevens Institute of Technology and Rutgers University Project Plan, Quality Assurance Plan, and Standard Operating Procedures for Study I-E New Jersey Toxics Reduction Workplan: (Newark Bay, Kill Van Kull, and Arthur Kill), Version 1.1, February 23, 2001.
- Pence, A.M., M.S. Bruno, A.F. Blumberg, B.J. Fullerton, and K.L. Rankin 2006. The Hydrodynamics of the Newark Bay-Kills System. Stevens Institute of Technology Technical Report SIT-DL-05-9-2840, April 2006, 287 pp.
- U.S. Environmental Protection Agency-Region IV, Office of Quality Assurance, 1998. "Data Validation SOPs for PCDDs and PCDFs Analysis by HRGC/HRMS", Rev. 2.0, October 1998.

U.S. Environmental Protection Agency-Region X, Office of Quality Assurance, 1995. "Data Validation SOPs for PCDDs and PCDFs Analysis by HRGC/HRMS", Rev. 2.0, October 1995.

Wilson, T.P. and J.L. Bonin 2007. Concentrations and loads of organic compounds and trace elements in tributaries to Newark and Raritan bays, New Jersey. U.S. Geological Survey Scientific Investigations report.

## **APPENDICES**

## **APPENDIX A: USGS River Flow Conditions**

**(May 29, 2003; revised October 6, 2004)**

The purpose of this document is to present a classification scheme developed by the USGS-NJ to describe river flow conditions during the various baseflow (dry weather) and wet weather events sampled by the USGS and SIT as part of the NJ Toxics Reduction Workplan for NY-NJ Harbor. The wet weather river flow (storm) magnitude scale has been developed using data for the last 25 years of record for each river. A wet weather event is classified using the Mean Daily Discharge (MDD) at the head-of-tide USGS gauging station on the day the river flow peaked. The MDD is a different value than the peak discharge of a storm. However, generally (but not always), the MDD and peak discharge are close to each other and occur on the same day.

Table 1 lists the storms that were sampled by the USGS-NJ and the associated peak discharge reached, the Mean Daily Discharge on the peak day, and the storm magnitude assigned to the river (see Table 3). The table also lists the volume of water that USGS-NJ calculated passed the head-of-tide sampling station during the storm event (which may have lasted several days), and the sediment and carbon loads calculated for the storm event.

Table 2 lists the river discharge at the head-of-tide for the baseflow events. The Mean Daily Discharge for the day of sampling is listed, along with the daily volume and the calculated sediment and organic-C loads.

Table 3 lists the flow statistics for each river over the period 1975-2000 and identifies the river flow (storm) magnitude classification as a function of the peak day Mean Daily Discharge. For example, a magnitude 3 storm on the Passaic River had a Mean Daily Discharge (MDD) on the peak day for the storm event that fell between 203 and 355 cubic feet per second. The MDD for any day can be obtained from the USGS data files, either online or from the yearly publications. Table 3 also lists the number of events in an average year, and the total yearly flow of water in an average year.

Table 4 provides the yearly total discharges at the head-of-tide of each river for the water years that are being modeled by Hydroqual for the CARP.

Table 5 lists the sediment loads calculated for the storms that USGS-NJ sampled. The MVUE (Maximum Variance Unbiased estimator) corrected loads should be used for modeling and other analyses; the other calculated loads are provided for comparison purposes only.

**Table 1. River discharge data at the head-of-tide and calculated loads of suspended sediment, particulate organic carbon, and dissolved organic carbon for storm events on New Jersey Rivers sampled by USGS-NJ.**

River	Date	Maximum Discharge reached in cfs	Maximum MDD in cfs	Magnitude	Volume of discharge, in Mgals	Sediment Load, in kg	Particulate organic carbon load, in kg	Dissolved organic carbon load, in kg
Passaic	<b>6/22/00</b>		<b>821</b>	<b>5</b>	<b>539</b>	<b>32,200</b>	<b>1430</b>	<b>9090</b>
	12/15/00	791	777	5	443.9	10,925	1,416	6,309
	<b>3/14/01</b>	<b>2,210</b>	<b>2200</b>	<b>6</b>	<b>11,499</b>	<b>531,456</b>	<b>28,479</b>	<b>159,846</b>
Raritan	<b>4/13/01</b>	<b>3,340</b>	<b>2,930</b>	<b>6</b>	<b>3,853</b>	<b>1,547,936</b>	<b>16,527</b>	<b>59,171</b>
	<b>3/3/02</b>	<b>3,690</b>	<b>2,050</b>	<b>6</b>	<b>3,226</b>	<b>1,712,913</b>	<b>79,290</b>	<b>42,174</b>
	<b>3/21/02</b>	<b>7,880</b>	<b>5,430</b>	<b>6</b>	<b>7,520</b>	<b>5,900,000</b>	<b>81,289</b>	<b>123,606</b>
	11/26/01	383	343	4	438.5	248,000	-	-
	12/09/01	464	409	4	117.5	22,700	-	-
	12/25/01	485	373	4	35.8	74,700	-	-
Rahway	<b>5/22/01</b>	<b>424</b>	<b>284</b>	<b>6</b>	<b>275.9</b>	<b>76,672</b>	<b>4,258</b>	<b>5,174</b>
	<b>4/28/02</b>	<b>585</b>	<b>324</b>	<b>7</b>	<b>349</b>	<b>66,930</b>	<b>4,605</b>	<b>6,443</b>
	10/15/01	146	71	5	53.87	2,977	-	-
	11/26/01	204	89	5	66.59	22,655	-	-
	12/9/01	302	133	5	95.40	10,425	-	-
	12/24/01	282	99	5	71.81	9,150	-	-
Elizabeth	<b>5/22/01</b>	<b>586</b>	<b>235</b>	<b>7</b>	<b>220.7</b>	<b>79,470</b>	<b>4,472</b>	<b>6,622</b>
	12/8/01	274	55	5	56.1	6,590	-	-
	12/24/01	266	54	5	34.93	6,319	-	-
	7/19/02	297	53	5	48.90	41,944	-	-

**Note: Bolded dates indicate storms sampled for sediment and chemical analysis, non-bolded dates were sampled only for suspended sediment.**

**Note: flow on the Hackensack River is controlled entirely by the Oradell Dam. For most of the NJTRWP sampling surveys, there was little (if any) flow over the dam into the river.**

cfs = cubic feet per second  
MDD = Mean Daily Discharge  
kg = kilogram  
Mgals = million gallons



**Table 2. River discharge data at the head-of-tide and calculated loads of suspended sediment, particulate organic carbon, and dissolved organic carbon during base flow on New Jersey Rivers sampled by USGS-NJ.**

<b>River</b>	<b>Date Sampled</b>	<b>Note</b>	<b>MDD in cfs</b>	<b>Volume of discharge, in Mgals per day</b>	<b>Sediment Load, in kg per day</b>	<b>Particulate organic carbon load, in kg per day</b>	<b>Dissolved organic carbon load, in kg per day</b>
<b>Raritan</b>	<b>6/27/00</b>		<b>286</b>	<b>188</b>	<b>2,270</b>	<b>180</b>	<b>2920</b>
	<b>10/04/01</b>	<b>A</b>	<b>180</b>	<b>118</b>	<b>2,200</b>	<b>984</b>	<b>1700</b>
<b>Passaic</b>	<b>10/17/01</b>		<b>171</b>	<b>112</b>	<b>3,970</b>	<b>364</b>	<b>1760</b>
<b>Rahway</b>	<b>6/28/00</b>		<b>25</b>	<b>16.4</b>	<b>211</b>	<b>18.6</b>	<b>209</b>
	<b>4/24/01</b>		<b>27</b>	<b>17.7</b>	<b>631</b>	<b>109</b>	<b>235</b>
<b>Elizabeth</b>	<b>6/29/00</b>		<b>11</b>	<b>7.22</b>	<b>120</b>	<b>6.83</b>	<b>96.4</b>
	<b>4/25/01</b>		<b>10</b>	<b>6.56</b>	<b>87</b>	<b>22.6</b>	<b>94.3</b>
<b>Hackensack</b>	<b>6/23/00</b>		<b>14</b>	<b>9.19</b>	<b>153</b>	<b>15.2</b>	<b>133</b>
	<b>10/19/01</b>		<b>2.3</b>	<b>1.51</b>	<b>15.7</b>	<b>5.98</b>	<b>18.4</b>

**Note A: Concentrations of SS for the Raritan River on 10/4/01 are thought to have been mistakenly reported by the laboratory. The load reported here was calculated using an estimated concentration of 5 mg/L. The measured SS concentrations results in a total sediment load for this period of base flow of 29,300 kg.**

cfs = cubic feet per second  
MDD = Mean Daily Discharge  
kg = kilogram  
Mgals = million gallons

**Table 3. Summary of hydrologic events in New Jersey Rivers during an average year and river flow condition (storm) magnitude classification scheme. Based on mean daily discharge records, water years 1975 through 2000.**

Exceedance level	Magnitude	Passaic	Raritan	Rahway	Elizabeth	Hackensack
Average yearly flow, in Mgals		256,500	284,200	13,200	6350	14,200 <sup>a</sup>
“Low/Base-Flow”	1	125 cfs (35 days)	165 cfs (39 days)	3.6 cfs (34 days)	5.6 cfs (30 days)	<0.5 cfs (86 days)
<b><u>Peak day Mean Daily Discharge (cubic feet per second) reached and number of events</u></b>						
90%	2	125-202 (5 events)	168-202 (11 events)	3.6-9.7 (7 events)	5.6-7.7 (8 events)	0.5-0.6 (8 events)
75%	3	203-355 (7)	203-333 (17)	9.8-18 (11)	7.8-11 (12)	0.6-1.0 (12)
50%	4	356-737 (12)	334-750 (28)	19-51 (19)	12-31 (20)	1.1-5.7 (22)
25%	5	738-1660 (12)	751-2010 (28)	52-153 (19)	32-78 (20)	5.9-20 (21)
10%	6	1661-2970 (7)	2011-6150 (17)	154-364 (11)	79-174 (12)	21-311 (13)
<10%	7	2970-18,000 (5)	6150-61,000 (11)	364-3670 (7)	175-1570 (8)	311-5580 (9)

**Note a: flow on the Hackensack River is controlled entirely by the Oradell Dam. For most of the NJTRWP sampling surveys, there was little (if any) flow over the dam into the river.**

cfs = cubic feet per second  
Mgals = million gallons

**Table 4. Summary of total discharge in select NJ rivers, WY 1988 through 2002.  
(Values in millions of gallons)**

<b>Water Year</b>	<b>Raritan</b>	<b>Passaic</b>	<b>Rahway</b>	<b>Elizabeth</b>	<b>Hackensack</b>
WY 1988	237,574	201,694	10,198	5,443	4,074
WY 1994	327,611	255,519	14,765	6,627	12,748
WY 1998	278,742	278,742	16,836	7,322	15,032
WY 1999	222,828	160,147	12,879	6,132	7,829
WY 2000	202,033	224,885	11,229	5,890	7,390
WY 2001	238,004	193,345	12,190	6,490	13,000
WY 2002	101,843	47,007	5,702	3,528	210
Average	229,805	194,477	11,971	5,918	8,612
25 Year Average	278,516	251,370	12,936	6,223	13,916
RPD	-19.2%	-25.5%	-7.7%	-2.5%	-47.1%

**Table 5. Sediment loads measured during USGS-NJ sampled storms and loads predicted using rating curve methods**

<b>River</b>	<b>Date</b>	<b>Magnitude</b>	<b>Maximum MDD for storm event, in cfs</b>	<b>Integrated load of sediment, in kg</b>	<b>Load of sediment from rating curve, uncorrected in kg</b>	<b>Load of sediment corrected using MVUE, in kg</b>	<b>Load of sediment corrected using QMLE, in kg</b>
<b>Passaic</b>	<b>12/15/00</b>	<b>5</b>	<b>777</b>	<b>10,925</b>	<b>63,643</b>	<b>80,321</b>	<b>85,781</b>
	<b>3/14/01</b>	<b>6</b>	<b>2200</b>	<b>531,406</b>	<b>1,192,403</b>	<b>1,466,960</b>	<b>1,607,163</b>
	<b>6/22/22</b>	<b>5</b>	<b>821</b>	<b>32,228</b>	<b>56,739</b>	<b>52,725</b>	<b>56,560</b>
	10/17/01	B	171	3,972	8,514	8,156	8,487
<b>Raritan</b>	<b>4/13/01</b>	<b>6</b>	<b>2,930</b>	<b>1,547,936</b>	<b>1,033,990</b>	<b>1,317,000</b>	<b>1,639,010</b>
	<b>3/3/02</b>	<b>6</b>	<b>2,050</b>	<b>1,712,913</b>	<b>370,054</b>	<b>553,710</b>	<b>586,581</b>
	<b>3/21/02</b>	<b>6</b>	<b>5,430</b>	<b>5,900,000</b>	<b>2,229,958</b>	<b>3,287,510</b>	<b>3,534,775</b>
	11/26/01	4	343	248,000	12,382	18,990	19,627
	12/09/01	4	409	22,700	9,516	14,500	15,084
	12/25/01	4	373	74,700	7,934	12,120	12,575
	<b>6/27/00</b>	<b>B</b>	<b>286</b>	<b>2,273</b>	<b>4,729</b>	6,904	7,497
	<b>Note a</b>	<b>10/4/01</b>	<b>B</b>	<b>180</b>	<b>2,200</b>	<b>1,936</b>	2,187
<b>Rahway</b>	<b>5/22/01</b>	<b>6</b>	<b>284</b>	<b>76,672</b>	<b>17,584</b>	<b>18,937</b>	<b>21,396</b>
	<b>4/28/02</b>	<b>7</b>	<b>324</b>	<b>66,930</b>	<b>24,678</b>	<b>25,064</b>	<b>30,028</b>
	10/15/01	5	71	2977	2,255	2,326	2,744
	11/26/01	5	89	22,655	3,375	1,956	4,108
	12/9/01	5	133	10,425	5,275	5,549	6,419
	12/24/01	5	99	9,150	3,265	3,611	3,973
	<b>6/28/00</b>	<b>B</b>	<b>25</b>	<b>211</b>	<b>497</b>	<b>579</b>	<b>605</b>
	<b>4/24/01</b>	<b>B</b>	<b>27</b>	<b>631</b>	<b>553</b>	<b>642</b>	<b>672</b>
	<b>Elizabeth</b>	<b>5/22/01</b>	<b>7</b>	<b>235</b>	<b>79,470</b>	<b>19,300</b>	<b>17,287</b>
12/8/01		5	55	6,590	2,568	2980	3,676
12/24/01		5	54	6,319	1,646	1403	2,356
7/19/02		5	53	41,944	2,126	2408	3,043
<b>6/29/00</b>		<b>B</b>	<b>11</b>	<b>120</b>	<b>138</b>	<b>182</b>	<b>198</b>
<b>4/25/01</b>		<b>B</b>	<b>10</b>	<b>87</b>	<b>118</b>	<b>158</b>	<b>170</b>
<b>Hackensack</b>		<b>6/23/00</b>	<b>B</b>	<b>14</b>	<b>153</b>	<b>363.5</b>	<b>570</b>
	10/19/01	B	2.3	15.7	61.2	505	137

**Bolded values are storms collected for chemical and sediment data.**

**Note a: Concentration of suspended sediment estimated at 5 mg/L**

**cfs = cubic feet per second**

**MDD = mean daily discharge**

**kg = kilogram**

**MVUE - Maximum Variance Unbiased Estimator**

**QMLE - Quasi-Maximum Likely Estimator**

**APPENDIX B: QA ISSUE: SIT Dissolved Metals Blank Contamination**  
**(January 10, 2003)**

**Problem:** beginning with some of the Fall 2001 SIT (Studies I-D and I-E) survey data, a notable increase in Equipment Blank contamination for some dissolved metals (in particular, Cd and Pb) was observed. See Table 1 and Figures 1 through 4.

**Table 1: SIT Equipment Blank dissolved metals concentrations (ng/L).**

<b>SIT DISSOLVED METALS:</b>	Cadmium-EB	Cadmium-FB	Lead-EB	Lead-FB	Mercury-EB	Mercury-FB	methylHg-EB
Jun-00	1.45		6.1		0.37		0.033
Dec-00	0.45		18		0.57		0.003
Mar-00	2.6	4.4	14.6	27.7	1.18	1.42	0.005
2001 April	4.4		53.9		3.59		0.0025
May-01	2.2	2.7	32.7	52.4	21.2	3.59	0.221
2001 Oct	51.6		148		0.7		
2001 Nov	88.6		1120		0.61		0.014
Mar-02	25.6		361		1.4		0.006
Mar-02	50.2		742		853		0.069
May-02	Total=3.5	4.3	Total=60	87	Total=5.78	1.16	Total=0.013

Note: in the April 2001 surveys, the dissolved Hg and Pb values were greater than the Total Hg and Pb values in the Equipment Blank, and the analytical lab reported a suspected field or lab contamination problem with the Hg Equipment Blank data. For the May 2001 data, the analytical laboratory reported a suspected field or lab contamination problem with the Hg and methyl-Hg Equipment Blank data. For the October 2001 data, the dissolved EB values for Cd, Hg, and Pb were greater than the Total EB values; the laboratory suggested that these EB blank containers may have been mislabeled. Ignore all other shading. In the May 2002 survey, dissolved EB were not collected; the values for the Total metals EB are shown for comparison purposes only and are indicative of the effect of implemented correction procedures.

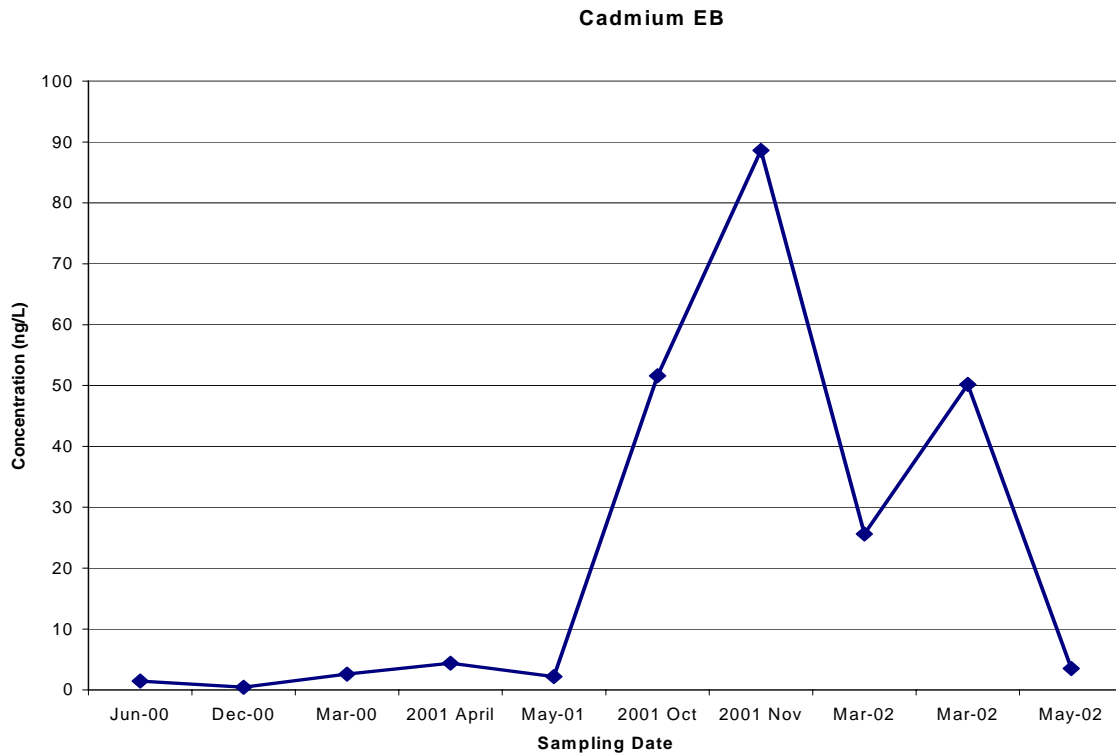
**Additional Observations:** the Equipment Blank data that appears to be unusually high are the following -

- Cadmium - Oct and Nov 2001, March 2002 (both)
- Lead - April 2001, Oct and Nov 2001, March 2002 (both)
- Mercury - April and May 2001, March 2002 (2<sup>nd</sup> data set)

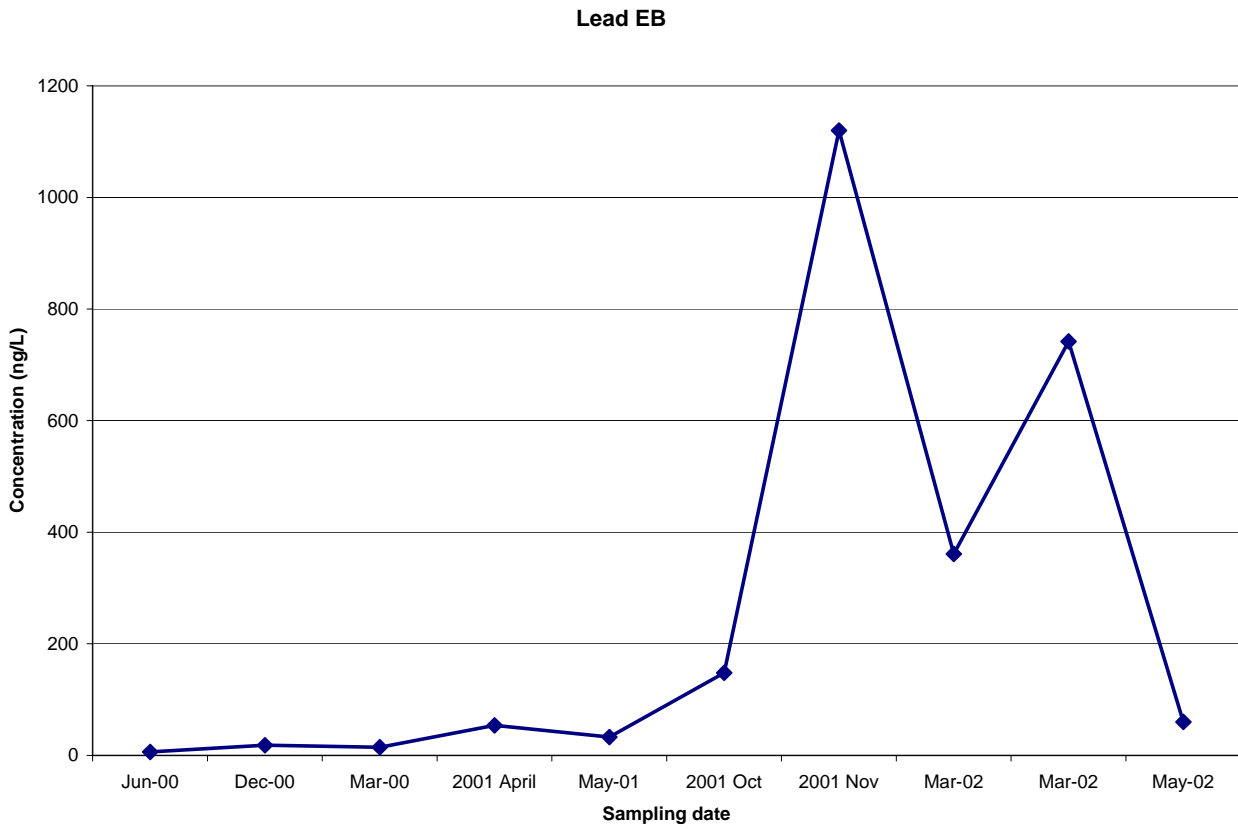
**Possible Cause:** the SIT researchers have used the same, dedicated length of Teflon sampling tubing when collecting metals Equipment Blanks. This tubing could have become contaminated some time between April and October 2001.

**Supporting Evidence:** when collecting the Equipment Blanks for the April 2002 Hackensack River Metals Special Study, the dedicated tubing noted above was not used - only the filter and tubing supplied by the analytical lab was used. Data for these Equipment blanks are as follows, and indicate minimal contamination (units = ng/L): cadmium - <1.0; lead - 11.7; mercury - 0.40; methyl-Hg - <0.009. After recognition of this problem and its possible cause, SIT instituted measures to correct it by using new tubing for each EB - the effects of this can be observed in the lower EB contamination values reported for the May 2002 data.

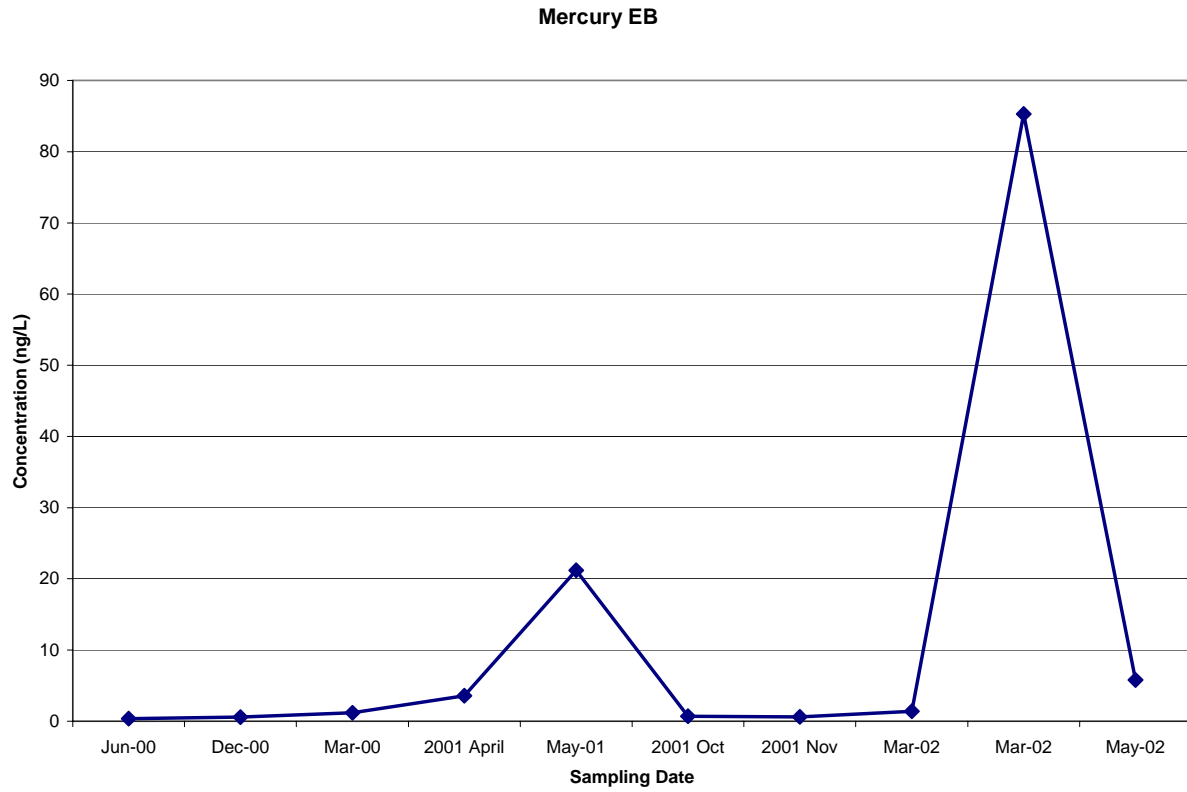
**Figure 1: SIT dissolved Cadmium Equipment Blank data.**



**Figure 2: SIT dissolved Lead Equipment Blank data.**

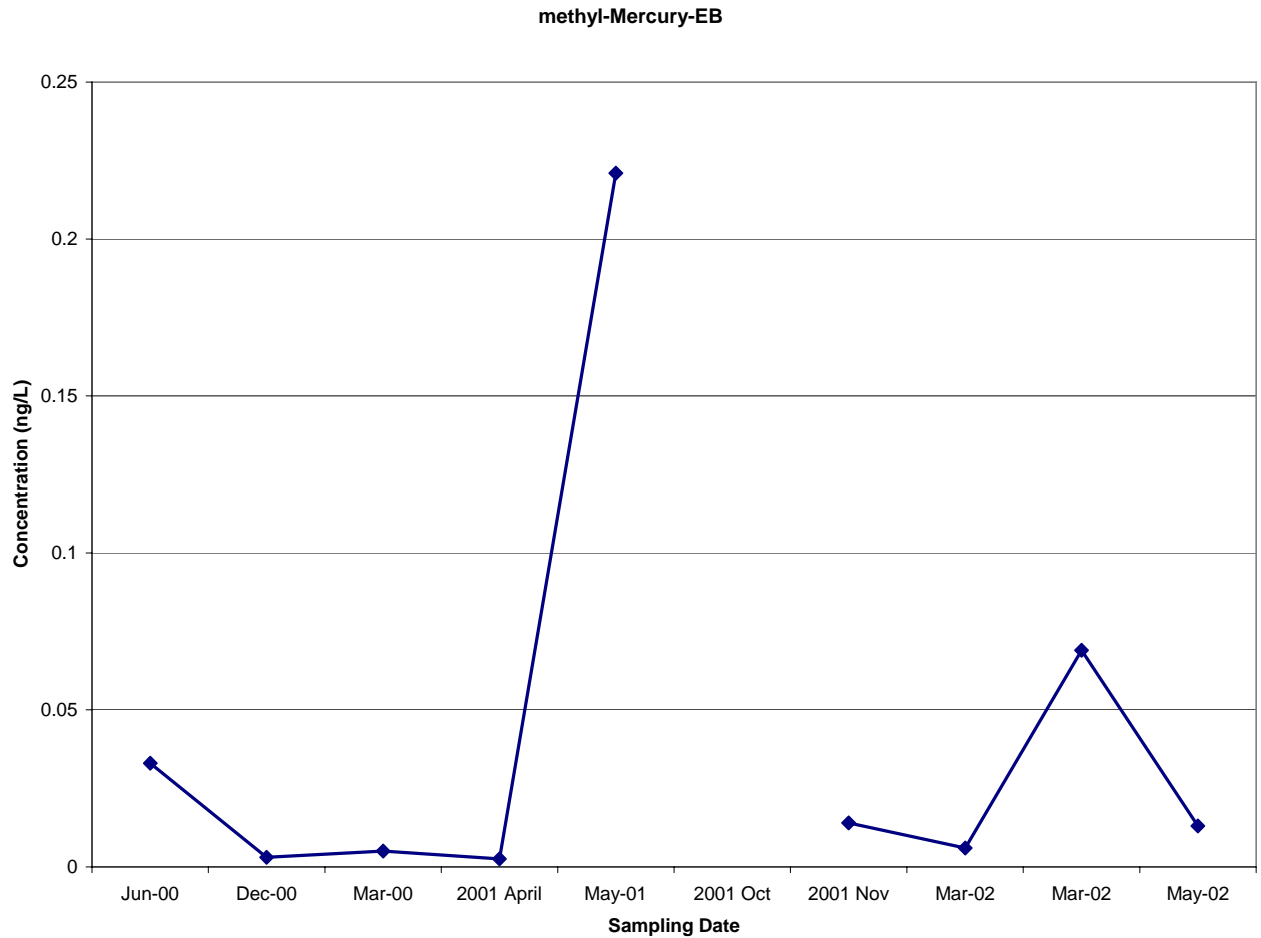


**Figure 3: SIT dissolved Mercury Equipment Blank data.**





**Figure 4: SIT dissolved methyl-Hg Equipment Blank data.**



**Recommendation:**

When evaluating blank contamination effects on the "impacted" sampling dates/analytes [Cadmium - Oct and Nov 2001, March 2002 (both); Lead - April, Oct, and Nov 2001, March 2002 (both); Mercury - April and May 2001, March 2002 (2<sup>nd</sup> data set)], the average for the Equipment Blank data for the "non-impacted" sampling dates should be used. These values are as follows:

**Cadmium = 2.22 ng/L**

**Lead = 17.85 ng/L**

**Mercury = 0.81 ng/L**

## **Appendix A - Statistical Analyses**

Due to the small sample size, t-tests were run for the equipment blank data comparing the June 2000-May 2001 data to the October 2001-March 2002 data. For cadmium and lead the t-tests indicated the means were significantly different (cadmium: means of 2.22 and 54.0 ng/L, respectively,  $p=0.002$ ; lead: means of 25.06 and 592.75 ng/L, respectively,  $p=0.019$ ).

Mercury and methylmercury means were not significantly different ( $p=0.302$  and  $0.704$ , respectively) when comparing these same sample periods. However, several values were substantially elevated in the mercury and methylmercury blank data. The 853 ng/L value for mercury on March 2002 is highly elevated over all other samples indicating its likelihood as an outlier. Mercury values of 3.59 ng/L (April 2001) and 21.2 ng/L (May 2001) were also suspect. When a stepwise comparison to the other mercury values was conducted (after eliminating the 853 ng/L), both values were found to be outside of the respective mean  $\pm 2$  standard deviations. This lends weight to considering these values as outliers. The methylmercury value of 0.221 (May 2001) was also elevated as compared to all other equipment blank methylmercury values, and when compared to the mean  $\pm 2$  standard deviations, it also falls outside of this range.

## APPENDIX C: QA ISSUE: SIT PHASE I DISSOLVED HG DATA – BLANK CONTAMINATION IMPACTS

Draft – April 2, 2004

**Problem:** use of the standard NJTRWP blank correction procedure – the “maximum blank approach” with a “5x factor” – results in the censoring (“loss”) of 88% (67 of 76 samples) of the SIT Phase I tributary and estuary sample data.

Survey Date	# Samples	Min Sample	Max Sample	EB	# Samples ≤ EB
Jun-00	6	0.94	1.25	0.37	0
Dec-00	11	0.78	3.03	0.57	0
Mar-01*	12	1.06	2.85	1.18	1
Apr-01^	8	0.71	2.93	0.81^	1
May-01^	9	1.18	23.5	0.81^	0
Oct-01	10	0.46	1.64	0.7	3
Oct-01	3	0.84	2.97	0.44	0
Nov-01	6	0.42	0.92	0.61	3
Mar-02	4	2.02	7.87	1.4	0
Mar-02^	3	1.03	2.19	0.81^	0
May-02	4	1.89	11.3	0.81^	0
<b>Mean</b>		<b>1.03</b>	<b>5.50</b>	<b>0.65</b>	
*Field Blank = 1.42 ng/L					
^EB was contaminated; mean of uncontaminated EB used					

Table 1 summarizes the SIT tributary/estuary sample and Equipment Blank (EB) data. Only one Field Blank for Dissolved-Hg was collected (March-01), so most of the observed blank contamination impacts were the result of the EBs. Due to improper cleaning and storage procedures, the EBs for some of the surveys were contaminated with unusually high levels of Hg, and were not used.

The EBs had a mean value of 0.65, with a range of 0.37 – 1.4, suggesting little overall variability in contamination of the EBs. In addition, only 8 samples had dissolved Hg levels less than the associated EB. This analysis indicates that applying the NJTRWP “maximum blank approach” with a 5x factor to the Dissolved Hg data may be overly conservative and result in many false negatives (non-detects) when using the data.

Method Detection Limits (MDLs) for the SIT samples ranged between 0.02 and 0.30 ng/L (mean = 0.10 ng/L; n=23). This indicates that both the sample and EB data were reliable.

In order to further evaluate potential blank contamination impacts on the SIT dissolved Hg data, two additional analysis were conducted:

- (1) Use of the NJTRWP “maximum blank approach” but with a “3x factor” – 77% of the sample data (58 of 75 samples) was blank-censored (i.e. “lost”);
- (2) Blank subtraction – 12% (9 of 75) samples had a result  $\leq 0$  (i.e. non-detect or “lost”).

The results of this analysis indicates that 88% of the samples had values between 1x and 3x the associated EB. In addition, use of the “3x factor” in the NJTRWP “maximum blank approach” only increased the useable data by ~10%.

Table 2 shows mean dissolved Hg data for samples collected by SIT and the NYSDEC at similar locations in NY-NJ Harbor.

<b>NJTRWP Site</b>	<b>NYSDEC Site</b>	<b>NJTRWP Mean &gt;3x Max Blank</b>	<b>NJTRWP Mean Blank Subtract</b>	<b>NYSDEC CARP Mean</b>
PAS1	Passaic-M	1.25	0.81	1.7
PAS2	Passaic-MT	2.29	1.05	1.5
NB1-S	Newark Bay	ND	0.54	1.6
AK1-S	Northern AK	4.25	0.97	0.85
HAC1	Hack-M	1.23	0.54	1
HAC2	Hack-MT	1.78	2.25	2.7

Comparison of the NJTRWP data with the NYSDEC data indicates no consistent trends among the 6 sampling locations. However, in general, the differences between the NYSDEC CARP means and the NJTRWP blank-subtracted means are smaller than those with the NJTRWP >3X Max Blank means.

**Conclusion:** both the sample and Equipment Blank data were consistently found at levels greater than the MDL, indicating that the data is reliable. The range (0.37 – 1.4 ng/L) of values reported for the EBs was small, suggesting relatively consistent EBs throughout the Phase One sampling. In addition, the range in EB values was smaller than that reported for the samples (0.42 – 23.5 ng/L). Given this, use of the NJTRWP “maximum blank approach” with a “5x/3x factor” appears to be overly conservative, as it results in the censoring (“loss”) of 88%/77% of the sample data. In contrast, use of simple blank subtraction results in the loss of only 12% of the sample data.

Therefore, it has been determined that the effects of blank contamination on the SIT dissolved Hg data will be assessed using the following 2-step procedure:

- (1) blank subtraction of the maximum associated blank (the EB, except in the March 2001 data), and
- (2) censoring any resulting value that is less than the associated MDL for that sample.

Application of this procedure results in the revised SIT dissolved Hg data show in Table 3, and results in the censoring (“loss”) of data for ~21% (16 of 75) of the samples.

In addition, the May 2001 PA-S and PA-D samples are very large compared to the other samples collected at these locations, as well as from other areas of the harbor. In addition, the EB for the May 2001 SDG was contaminated with a value of 21.2 ng/L (and thus was one of the EBs not used for blank contamination impact assessment purposes). The Total Hg for these samples did not appear to be elevated. Therefore, the May 2001 PA-S and PA-D dissolved Hg data should be considered to be outliers and should not be used.

Compared to other samples on different dates, the March 13, 2002 samples at stations HAC2 and (in particular) KVK were elevated. Although the EB for the March 13, 2002 SDG was slightly elevated (1.40 ng/L), it was not considered to be an outlier. The Total Hg for these samples also did not appear to be elevated. Therefore, the data for these 2 samples presented in Table 3 should be used.

Another elevated sample result was observed for the May 2002 Elizabeth River sample. The other samples collected on this date at different locations appear to be elevated when compared to samples collected at different dates. There was no EB on this sample date. The Total Hg for these samples did not appear to be elevated. Therefore, the data for the May 2002 samples presented in Table 3 should be used.

Table 3: SIT Phase One Dissolved Hg Data – Revised Blank Correction Procedure (ng/L)											
DATE:	Jun 00	Dec 00	Mar 01	12 Apr 01	May 01	17 Oct 01	3 Oct 01	Nov 01	13 Mar 02	27 Mar 02	May 02
SITE											
PAS1	0.88	0.47	1.09			B					
PAS2		1.72	1.19			0.24					
PAS3		1.61	1.09			0.12					
NB1-S	0.57	0.5	B			B					
NB1-D	0.34	0.55	B			B					
NB3		0.7	B			0.58					
AK1-S		0.59	B	0.15	0.37			0.31			3.44
AK1-D				0.33	0.58			B			1.73
PA-S		0.47	B		22.69			0.14			
PA-D				B	16.2			B			
HAC1	0.86	0.7	B			0.5			0.62		
HAC2		1.21	1.43			0.94			5.42		
HAC3		2.46	1.1			0.21			2.41		
KVK		B	B			B			6.37		
RAR1-S				0.75	0.71		0.79			0.22	
RAR1-D				0.4	0.75		0.4			0.25	
RAR2				2.12	1.72		2.53			1.38	
RWY				0.3	4.6			0.11			1.08
ELIZ				0.75	5.9			B			10.49
B = blank corrected and censored.											
May 2001 samples – see text; these samples are considered to be outliers and should not be used.											

## **APPENDIX D: Data Analysis SOP**

### **Normalized Dissolved Contaminant Concentration**

The dissolved concentrations recovered from the XAD columns used in the TOPS will be normalized using:

$$\text{Dissolved concentration} = \frac{\text{mass of contaminant recovered (pg or ng)}}{\text{Volume of water pumped through XAD columns (L)}}$$

The volume of water pumped through the XAD columns is by adding up the net weight of water collected in the Post-XAD Carboy and the net weight of water used for Post-XAD sampling (i.e. Post-XAD SS samples and Post-XAD TOC/DOC samples).

### **Normalized Sediment Contaminant Concentration**

The sediment contaminant concentrations recovered from the filters (Cartridge Filter and Flat Filter) used in the TOPS will be normalized using:

#### **Normalized concentration of contaminant**

$$\text{In unit mass of sediment} = \frac{\text{mass of contaminant recovered (pg or ng)}}{\text{Estimated mass of sediment recovered on all TOPS filters submitted for analysis (g)}}$$

The mass of sediment recovered on all TOPS filters submitted for analysis ( $m_{\text{FILTERS}}$ ) is estimated by :

$$m_{\text{FILTERS}} = V_{\text{CARTRIDGE}} * (\text{SS}_{\text{INTAKE}} - \text{SS}_{\text{WASTE}}) + V_{\text{FLAT}} * (\text{SS}_{\text{WASTE}} - \text{SS}_{\text{POST FLAT}})$$

where:

$V_{\text{CARTRIDGE}}$  : the volume of water that passes through the cartridge filter estimated by adding the waste volume and the volume of water that passes through the XAD columns

$\text{SS}_{\text{INTAKE}}$  : the geometric mean of all SS samples collected at the intake

$\text{SS}_{\text{WASTE}}$  : the geometric mean of all SS samples collected at the waste

$V_{\text{FLAT}}$  : the volume of water that passes through the flat filter estimated by adding by adding up the net weight of water collected in the Post-XAD Carboy and the net weight of water used for Post-Flat Filter sampling and the net weight of water used for Post-XAD sampling (i.e. Post-Flat and Post-XAD SS TOC/DOC samples)

$\text{SS}_{\text{POST FLAT}}$  : the geometric mean of all SS samples collected past the flat filter

## **Carbon Normalized Dissolved Contaminant Concentration**

### **Carbon Normalized**

$$\text{Dissolved concentration} = \frac{\text{dissolved contaminant concentration (pg/L or ng/L)}}{\text{Dissolved carbon concentration (mg DOC / L)}}$$

The dissolved carbon concentration is determined as the geometric mean of the DOC concentration of all samples collected at the intake.

## **Carbon Normalized Sediment Contaminant Concentration**

### **Carbon Normalized**

$$\text{sediment concentration} = \frac{\text{sediment contaminant concentration (pg/g sed or ng/g sed)}}{\text{Carbon concentration in suspended sediment (mg POC / g)}}$$

To determine the carbon concentration in the suspended sediment (mg POC / g sed) the geometric mean of the POC concentration of all samples collected at the intake (mg POC /L) is divided by the geometric mean of the suspended sediment concentration of all samples collected at the intake (mg/L).

## APPENDIX E: NJTRWP SIT Water Grab Sample PAH

### Blanks

(Draft – September 10, 2003)

An initial review of the Method, Equipment, and Field Blanks associated with the SIT PAH water grab/composite samples has been implemented, covering the surveys conducted from December 2000 through May 2002. Based on an initial subjective analysis, the surveys were divided into two groups.

The following table shows the mean Field, Method, and Equipment Blank data from a total of 10 Study I-D and I-E surveys completed during the time period December 2000 through May 2001, hereafter designated as the "Group 1" samples. The "Maximum Mean Blank" for each analyte is highlighted in grey in the table (note: a few incorrect shadings are also highlighted in yellow-ignore these).

SIT Grab Samples Group 1	Group 1 Mean FB	Group 1 FB Std Dev	Group 1 Mean MB	Group 1 MB Std Dev	Group 1 Mean EB	Group 1 EB Std Dev
Units: ng/L						
Naphthalene	28.12	46.84	17.34	7.71	172.50	285.07
Biphenyl	7.20	3.27	10.00	0.00	6.75	1.77
Acenaphthene	2.60	0.28	2.50	0.46	0.00	0.00
1-Methylnaphthalene	6.26	1.41	8.42	5.51	11.03	3.55
2-Methylnaphthalene	9.51	6.40	11.34	8.63	22.38	15.82
2,6-Dimethylnaphthalene	6.73	5.43	8.13	7.70	4.83	1.92
2,3,5-Trimethylnaphthalene	0.00	0.00	6.10	0.00	2.70	0.00
Acenaphthylene	0.00	0.00	0.00	0.00	0.00	0.00
Fluorene	1.54	0.23	2.43	1.04	1.50	0.28
Anthracene	2.58	0.67	0.00	0.00	0.00	0.00
Phenanthrene	3.42	0.79	3.63	0.81	3.50	1.13
1-Methylphenanthrene	3.50	0.00	3.20	0.00	0.00	0.00
Fluoranthene	2.20	0.87	0.00	0.00	0.00	0.00
Pyrene	2.46	0.66	2.10	0.10	4.20	0.00
Chrysene	0.00	0.00	0.00	0.00	0.00	0.00
Benzo(a)anthracene	2.20	0.00	0.00	0.00	0.00	0.00
Benzo(b)fluoranthene	0.00	0.00	0.00	0.00	0.00	0.00
Benzo(k)fluoranthene	0.00	0.00	0.00	0.00	0.00	0.00
Benzo(a)pyrene	0.00	0.00	0.00	0.00	0.00	0.00
Benzo(e)pyrene	2.00	0.00	0.00	0.00	0.00	0.00
Dibenz(a,h)anthracene	3.77	2.06	3.93	1.30	2.90	0.00
Indeno(1,2,3-cd)pyrene	6.15	1.20	4.70	0.00	0.00	0.00
Perylene	0.00	0.00	0.00	0.00	0.00	0.00
Benzo(ghi)perylene	6.23	1.80	3.85	0.21	0.00	0.00
C2 Alkylnaphthalenes	9.89	7.71	20.95	23.19	16.10	12.92
C3 Alkylnaphthalenes	4.71	3.83	10.52	13.90	5.03	4.02
Total PAH ng/L	96.48	NA	87.68		232.29	



The following table lists the number of Field, Method, and Equipment Blanks in which an analyte was detected for the Group 1 samples. There were a total of 37 Field Blanks, 9 Method Blanks, and 4 Equipment Blanks in the Group 1 samples.

SIT Grab Samples	Group 1 #FB (37)	Group 1 #MB (9)	Group 1 #EB (4)
Naphthalene	32	7	4
Biphenyl	3	1	2
Acenaphthene	2	3	0
1-Methylnaphthalene	11	5	3
2-Methylnaphthalene	36	8	4
2,6-Dimethylnaphthalene	3	3	3
2,3,5-Trimethylnaphthalene	0	1	1
Acenaphthylene	0	0	0
Fluorene	5	3	2
Anthracene	5	0	0
Phenanthrene	17	6	2
1-Methylphenanthrene	1	1	0
Fluoranthene	5	0	0
Pyrene	11	3	1
Chrysene	0	0	0
Benzo(a)anthracene	1	0	0
Benzo(b)fluoranthene	0	0	0
Benzo(k)fluoranthene	0	0	0
Benzo(a)pyrene	0	0	0
Benzo(e)pyrene	1	0	0
Dibenz(a,h)anthracene	9	6	1
Indeno(1,2,3-cd)pyrene	2	1	0
Perylene	0	0	0
Benzo(ghi)perylene	4	2	0
C2 Alkylnaphthalenes	21	6	3
C3 Alkylnaphthalenes	22	5	3

### **Observations:**

- (1) "Total Group 1 Mean Blank PAH" (not including the C2 and C3 alkylnaphthalenes) was largest for the Equipment Blanks (232.3 ng/L), and similar for the Field (96.5 ng/L) and Method (87.7 ng/L) Blanks. The Equipment Blank Mean Total PAH is heavily skewed by a value of 600 ng/L for naphthalene in the December 2000 survey. Omitting this Equipment Blank results in a "Total Group 1 Mean Equipment Blank PAH" of only 92.1 ng/L, which is similar to that for the Field and Method Blanks.
- (2) Of 26 PAH analytes, the "Group 1 Maximum Mean Blank" was found in the Field Blank for 8 of these compounds, in the Method Blank for 8 of the compounds, and in the Equipment Blank for 4 of the compounds.
- (3) No contamination was reported for the following 6 compounds in any of the blanks collected: acenaphthylene, chrysene, benzo(b)fluoranthene, benzo(k)fluoranthene, benzo(a)pyrene, and perylene.
- (4) Only 4 of the PAH analytes were consistently found in all three of the Group 1 Field, Method, and Equipment Blanks: naphthalene, 2-methylnaphthalene, and the C2 and C3 Alkylnaphthalenes. At least half of the 9 Method Blanks were also contaminated with 1-methylnaphthalene (5), phenanthrene (6), and dibenz(a,h)anthracene (6). Three of the 4 Equipment Blanks were also contaminated with 1-methylnaphthalene and 2,6-dimethylnaphthalene. However, less than half of the 37 Field Blanks were contaminated with 1-methylnaphthalene (11), phenanthrene (17), or dibenz(a,h)anthracene (9), and only 3 Field Blanks were contaminated with 2,6-dimethylnaphthalene.
- (5) Comparing the mean  $\pm$  2 Std Dev for each PAH analyte, the only compounds for which a "significant difference" between the Field, Method, and Equipment Blanks appeared to have been found were:
  - Acenaphthene (found in only 2 Field and 3 Method Blanks, but not in any of the Equipment Blanks)
  - 2,3,5-Trimethylnaphthalene (found in only one Method Blank and one Equipment Blank)
  - Anthracene (found in only 5 Field Blanks)
  - 1-Methylphenanthrene (found in only one Field Blank and one Method Blank)
  - Fluoranthene (found in only 5 Field Blanks)
  - Pyrene (found in 11 Field Blanks, but only 3 Method and one Equipment Blanks)
  - Benzo(a)anthracene (found only once in a Field Blank)
  - Benzo(e)pyrene (found only once in a Field Blank)
  - Indeno(1,2,3-cd)perylene (found in only 2 Field and 1 Method Blanks, but not in any of the Equipment Blanks)
  - Benzo(ghi)perylene (found in only 4 Field and 2 Method Blanks, but not in any of the Equipment Blanks)

In general, except for pyrene in the Field Blanks, these "significant differences" were the result of only occasional contamination of a blank by an analyte. This suggests that there is little overall difference between the Method, Equipment, and Field Blanks.

The following table shows the mean Field, Method, and Equipment Blank data from a total of 10 Study I-D and I-E surveys completed during the time period October 2001 through May 2002, hereafter designated as the "Group 2" samples. The "Maximum Mean Blank" for each analyte is highlighted in grey in the table (note: a few incorrect shadings are also highlighted in yellow-ignore these).

SIT Grab Samples Group 2	Group 2 Mean FB	Group 2 FB Std Dev	Group 2 Mean MB	Group 2 MB Std Dev	Group 2 Mean EB	Group 2 EB Std Dev
Naphthalene	27.08	16.47	43.4125	24.60	57.98	23.27
Biphenyl	2.72	1.90	3.53	1.36	8.67	9.60
Acenaphthene	1.00	0.76	1.48	0.91	1.66	0.80
1-Methylnaphthalene	6.07	4.05	10.07	5.65	11.97	5.49
2-Methylnaphthalene	11.68	7.69	20.03	11.93	22.26	10.98
2,6-Dimethylnaphthalene	2.14	1.19	3.33	1.37	3.39	1.00
2,3,5-Trimethylnaphthalene	0.50	0.00	0.00	0.00	0.00	0.00
Acenaphthylene	5.94	13.94	1.47	0.85	1.68	0.48
Fluorene	0.70	0.37	1.07	0.46	1.36	0.39
Anthracene	0.57	0.29	0.99	0.00	1.05	0.12
Phenanthrene	1.94	1.02	2.89	1.29	3.25	0.97
1-Methylphenanthrene	0.62	0.22	1.05	0.31	0.76	0.17
Fluoranthene	0.65	0.35	0.95	0.45	0.96	0.45
Pyrene	0.80	0.27	1.55	0.91	0.89	0.37
Chrysene	0.44	0.33	0.60	0.27	0.60	0.22
Benzo(a)anthracene	0.41	0.52	0.49	0.20	0.49	0.25
Benzo(b)fluoranthene	0.87	0.75	1.31	0.49	1.18	0.26
Benzo(k)fluoranthene	0.71	0.77	2.69	0.00	0.80	0.50
Benzo(a)pyrene	1.55	1.22	3.08	1.09	0.00	0.00
Benzo(e)pyrene	1.75	1.08	3.79	0.00	0.00	0.00
Dibenz(a,h)anthracene	1.39	1.99	3.71	2.30	1.97	0.72
Indeno(1,2,3-cd)pyrene	1.36	1.50	2.29	1.77	1.88	0.75
Perylene	1.56	1.19	3.68	0.00	1.49	0.00
Benzo(ghi)perylene	1.00	0.63	1.97	1.73	1.78	0.71
C2 Alkyl naphthalenes	9.22	5.58	12.79	7.42	12.84	6.22
C3 Alkyl naphthalenes	2.13	2.64	2.37	1.24	3.54	0.56
Total PAH ng/L	73.47	NA	115.43	NA	126.09	NA

The following table lists the number of Field, Method, and Equipment Blanks in which an analyte was detected for the Group 2 samples. There were a total of 32 Field Blanks, 8 Method Blanks, and 5 Equipment Blanks in the Group 2 samples.

SIT Grab Samples	Group 2 #FB (32)	Group 2 #MB (8)	Group 2 #EB (5)
Naphthalene	32	8	5
Biphenyl	32	8	5
Acenaphthene	28	8	4
1-Methylnaphthalene	32	8	5
2-Methylnaphthalene	32	8	5
2,6-Dimethylnaphthalene	29	7	5
2,3,5-Trimethylnaphthalene	1	0	0
Acenaphthylene	23	5	5
Fluorene	32	8	5
Anthracene	6	1	2
Phenanthrene	32	8	5
1-Methylphenanthrene	20	5	2
Fluoranthene	32	8	5
Pyrene	32	8	5
Chrysene	32	8	5
Benzo(a)anthracene	30	5	3
Benzo(b)fluoranthene	21	5	5
Benzo(k)fluoranthene	12	1	2
Benzo(a)pyrene	6	2	0
Benzo(e)pyrene	4	1	0
Dibenz(a,h)anthracene	17	5	4
Indeno(1,2,3-cd)pyrene	23	5	5
Perylene	4	1	1
Benzo(ghi)perylene	22	6	4
C2 Alkylnaphthalenes	32	8	5
C3 Alkylnaphthalenes	32	8	5

### **Observations:**

- (1) "Total Group 2 Mean Blank PAH" (not including the C2 and C3 alkyl naphthalenes) was largest and similar for the Equipment (126.1 ng/L) and Method Blanks (115.4 ng/L), and smaller for the Field Blanks (73.5 ng/L). The major contributor to this difference appears to be higher naphthalene levels in the Method and Equipment Blanks compared to the Field Blanks.
- (2) Of 26 PAH analytes, the "Group 2 Maximum Mean Blank" was found in the Field Blank for 2 of these compounds, in the Method Blank for 13 of the compounds, and in the Equipment Blank for 13 of the compounds.
- (3) Most of PAH analytes were consistently found in all three of the Group 2 Field, Method, and Equipment Blanks. Exceptions to this were the following:
  - 2,3,5-Trimethylnaphthalene (found in only one Field Blank)
  - Anthracene
  - Benzo(k)fluoranthene
  - Benzo(a)pyrene
  - Benzo(e)pyrene
  - Perylene
- (4) Comparing the mean  $\pm$  2 Std Dev for each PAH analyte, the only compounds for which a "significant difference" between the Field, Method, and Equipment Blanks appeared to have been found were:
  - 2,3,5-Trimethylnaphthalene (found only once in a Field Blank)
  - \*Benzo(k)fluoranthene (found in 12 Field Blanks, but in only 1 Method Blank and in only 2 Equipment Blanks)
  - Benzo(a)pyrene (found in only 6 Field and 2 Method Blanks, but not at all in the Equipment Blanks)
  - Benzo(e)pyrene (found in only 4 Field and 1 Method Blanks, but not at all in the Equipment Blanks)
  - Perylene (found in only 4 Field, 1 Method, and 1 Equipment Blank)

Except for \*Benzo(k)fluoranthene, which was found frequently in the Field Blanks but not in the Method and Equipment Blanks, these "significant differences" were the result of only occasional contamination of some of the blanks by an analyte. This suggests that there is little overall difference between the Method, Equipment, and Field Blanks.

\*Benzo(k)fluoranthene: the largest value (2.69 ng/L) - which would appear to be the "cause" of the observed "significant difference" - occurred only once in a Method Blank, and thus could be considered an outlier. The Equipment Blank result ( $0.80 \pm 0.50$  ng/L) was similar to the mean of the 12 Field Blank results ( $0.71 \pm 0.77$  ng/L). Thus, other than the greater frequency of occurrence of benzo(k)fluoranthene in the Field Blanks (12 of 32 collected), there does not appear to be a large difference in the levels of this compound between the three types of blanks.

### **Group 1 and Group 2 Comparison:**

(1) More of the PAH analytes were consistently found in the Group 2 blanks than in the Group 1 Blanks. Exceptions to this general observation were those analytes found infrequently in both Groups:

- 2,3,5-Tri-Methylnaphthalene
- Anthracene
- Benzo(k)fluoranthene
- Benzo(a)pyrene
- Benzo(e)pyrene
- Perylene

All of the PAH analytes found consistently in the Group 1 Blanks were also found consistently in the Group 2 Blanks (naphthalene, 2-methylnaphthalene, C2 and C3 alkylnaphthalenes). Sixteen (16) of the PAH analytes were found consistently in the Group 2 Blanks, but not in the Group 1 Blanks.

(2) Of the 26 PAH analytes, the "Group 1 Maximum Mean Blank" was fairly evenly distributed among the Field Blank (8), Method Blank (8), and no blank contamination (6) categories. In contrast, the "Group 2 Maximum Mean Blanks" were concentrated in the Method Blank (13) and Equipment Blank (13) categories.

(3) The "Total Group 2 Mean Blank PAH" was smaller than the "Total Group 1 Mean Blank PAH" for the Field (RPD = 27.1%) and Equipment (RPD = 59.35%) Blanks, but larger for the Method Blanks (RPD = 27.3%). Omitting the December 2000 survey outlier value for naphthalene in the Group 1 Equipment Blanks results in a "Total Mean Group 1 Equipment Blank PAH" of 92.1 ng/L, which is smaller than that for the Group 2 Equipment Blanks (RPD = 31.2%).

Thus, it appears that the "Mean Total PAH" in the Group 2 Method and Equipment Blanks are ~30% greater than that in the Group 1 Method and Equipment Blanks, whereas the "Mean Total PAH" in the Group 1 Field Blanks is ~30% greater than that in the Group 2 Field Blanks.

(4) Comparing the mean  $\pm$  2 Std Dev for each PAH analyte, the only compounds for which a "significant difference" between the Group 1 and Group 2 Field Blanks was found were:

- 2,3,5-Trimethylnaphthalene (but found in only 1 Group 2 Field Blank)
- \*Acenaphthylene (found in 23 Group 2 Field Blanks, but not in the Group 1 Field Blanks)
- Anthracene (found in only 6 Group 2 Field Blanks and 5 Group 1 Field Blanks)
- \*1-Methylphenanthrene (found in 20 Group 2 Field Blanks, but in only 1 Group 1 Field Blank)
- \*\*Pyrene (found in all 32 Group 2 Field Blanks, and in 11 Group 1 Field Blanks)
- \*Chrysene (found in all 32 Group 2 Field Blanks, but not in the Group 1 Field Blanks)
- \*Benzo(a)anthracene (found in 30 Group 2 Field Blanks, but in only 1 Group 1 Field Blank)

- \*Benzo(b)fluoranthene (found in 21 Group 2 Field Blanks, but not in the Group 1 Field Blanks)
- \*Benzo(ghi)perylene (found in 22 Group 2 Field Blanks, and in 4 Group 1 Field Blanks)

A number of PAH analytes were found occasionally in the Group 2 Field Blanks, but not in the Group 1 Field Blanks: benzo(k)fluoranthene, benzo(a)pyrene, and perylene. Anthracene and benzo(e)pyrene were found infrequently in the Group 1 and Group 2 Field Blanks, while 2,3,5-trimethylnaphthalene was found in only 1 Group 2 Field Blank.

\*A number of the contaminants were found consistently in the Group 2 Field Blanks but only rarely or not at all in the Group 1 Field Blanks: acenaphthene, acenaphthylene, fluorene, 1-methylphenanthrene, chrysene, benzo(a)anthracene, benzo(b)fluoranthene, indeno(1,2,3-cd)pyrene, and benzo(ghi)perylene. These compounds are also consistently found in the Group 2 Method and Equipment Blanks, but only rarely (if at all) in the Group 1 Method and Equipment Blanks. In addition, except for acenaphthylene (whose concentration was highly variable in the Group 2 Field Blanks), the mean concentration of these compounds in the Group 2 Field Blanks were similar to or less than the mean concentration in the Group 2 Method and Equipment Blanks. This suggests that the source of contamination of the Group 2 Field Blanks for these compounds is not the result of "field activities", but is due to laboratory and/or equipment contamination.

\*\*Pyrene was found consistently in both the Group 1 and Group 2 Field Blanks. Its concentration appears to have been somewhat greater in the Group 1 Field Blanks ( $2.46 \pm 0.66$  vs  $0.80 \pm 0.27$  ng/L). While pyrene was found consistently, and at similar levels, in the Group 2 Method and Equipment Blanks, it was found only infrequently in the Group 1 Method and Equipment Blanks. This suggests that the source of contamination of the Group 2 Field Blanks for these compounds is not the result of "field activities", but is due to laboratory and/or equipment contamination. In contrast, pyrene was found only rarely in the Group 1 Method and Equipment Blanks, suggesting that the source of contamination of the Group 1 Field Blanks for this compound is the result of "field activities".

These results suggest that the Group 2 Field Blanks were consistently contaminated by more PAH compounds than the Group 1 Field Blanks, and that this was largely the result of contamination of the Group 2 Method and/or Equipment Blanks, not the result of "field activities".

Although the "Total Mean PAH" value for the Group 1 Field Blanks was greater than that for the Group 2 Field Blanks, this was largely the result of the infrequent occurrence of four contaminants (biphenyl, 2,6-dimethylnaphthalene, indeno(1,2,3-cd)pyrene, and benzo(ghi)perylene) at elevated levels in the Group 1 Field Blanks. Removing these four contaminants from the calculation of "Mean Total PAH" gives a value of 70.2 ng/L for the Group 1 Field Blanks, and 66.3 ng/L for the Group 2 Field Blanks (RPD = 5.7%).

The sum of the mean concentrations for the four PAH compounds found consistently in the Field Blanks from both Groups (naphthalene, 2-methylnaphthalene, and the C2 & C3 alkylnaphthalenes) were similar (Group 1 = 52.2 ng/L, Group 2 = 50.1 ng/L; RPD = 4.1%).

(5) Comparing the mean  $\pm$  2 Std Dev for each PAH analyte, the only compounds for which a "significant difference" between the Group 1 and Group 2 Method Blanks appeared to have been found were:

- \*\*Biphenyl (found in all 8 Group 2 Method Blanks, but in only 1 Group 1 Method Blank)
- 2,3,5-Trimethynaphthalene (found in only 1 Group 1 Method Blank)
- \*Acenaphthylene (found in 5 Group 2 Method Blanks, but not in the Group 1 Method Blanks)
- Anthracene (found in only 1 Group 2 Method Blank)
- \*\*1-Methylphenanthrene (found in 5 Group 2 Method Blanks, but in only 1 Group 1 Method Blank)
- \*Chrysene (found in all 8 Group 2 Method Blanks, but not in the Group 1 Method Blanks)
- \*Benzo(a)anthracene (found in 5 Group 2 Method Blanks, but not in the Group 1 Method Blanks)
- \*Benzo(b)fluoranthene (found in 5 Group 2 Method Blanks, but not in the Group 1 Method Blanks)
- Benzo(k)fluoranthene (found in only 1 Group 2 Method Blank, but not in the Group 1 Method Blanks)
- Benzo(a)pyrene (found in 2 Group 2 Method Blanks, but not in the Group 1 Method Blanks)
- Benzo(e)pyrene (found in only 1 Group 2 Method Blank, but not in the Group 1 Method Blanks)
- Perylene (found in only 1 Group 2 Method Blank, but not in the Group 1 Method Blanks)

A number of PAH analytes were found rarely in the Group 2 Method Blanks, but not in the Group 1 Method Blanks: anthracene, benzo(a)pyrene, benzo(e)pyrene, and perylene.

\*A number of PAH analytes were found consistently in the Group 2 Method Blanks, but only rarely (if at all) in the Group 1 Method Blanks: biphenyl, acenaphthene, acenaphthylene, 1-methylphenanthrene, chrysene, benzo(a)anthracene, and benzo(b)fluoranthene. See the above discussion of some of these compounds under #4 -Field Blanks. It appears as if there is laboratory and/or equipment contamination for these compounds in the Group 2 Blanks.

\*\*Biphenyl was found in only 1 Group 1 Method Blank at 10.0 ng/L, greater than the mean of the 4 Group 2 Method Blanks ( $3.53 \pm 1.36$  ng/L). This suggests this Group 1 Method Blank result was an outlier. A similar situation appears to be the case for the 1-methylphenanthrene data, where the 1 Group 1 result of 3.2 ng/L is greater than the mean Group 2 result of  $1.05 \pm 0.31$  ng/L.

These general trends in the Method Blank data suggest an increase in laboratory and/or equipment contamination in the Group 2 blanks and associated sample data. This is supported by a comparison of the "Mean Total PAH" in the Method and Equipment Blanks – see #3 above.



(6) Comparing the mean  $\pm$  2 Std Dev for each PAH analyte, the only compounds for which a "significant difference" between the Group 1 and Group 2 Equipment Blanks appeared to have been found were:

- \*\*Acenaphthene (found in 4 Group 2 Equipment Blanks, but not in the Group 1 Blanks)
- 2,3,5-Trimethylnaphthalene (found in only 1 Group 1 Equipment Blank)
- \*\*Acenaphthylene (found in all 5 Group 2 Equipment Blanks, but not in the Group 1 Blanks)
- Anthracene (found in only 2 Group 2 Equipment Blanks)
- 1-Methylphenanthrene (found in only 2 Group 2 Equipment Blanks)
- \*\*Fluoranthene (found in all 5 Group 2 Equipment Blanks, but not in the Group 1 Blanks)
- \*Pyrene (found in all 5 Group 2 Equipment Blanks, but in only 1 Group 1 Blank)
- \*\*Chrysene (found in all 5 Group 2 Equipment Blanks, but not in the Group 1 Blanks)
- \*\*Benzo(a)anthracene (found in 3 Group 2 Equipment Blanks, but not in the Group 1 Blanks)
- \*\*Benzo(b)fluoranthene (found in all 5 Group 2 Equipment Blanks, but not in the Group 1 Blanks)
- Benzo(k)fluoranthene (found in only 2 Group 2 Equipment Blank)
- \*\*Indeno(1,2,3-cd)pyrene (found in all 5 Group 2 Equipment Blanks, but not in the Group 1 Blanks)
- Perylene (found in only 1 Group 2 Equipment Blank)
- \*\*Benzo(ghi)perylene (found in 4 Group 2 Equipment Blanks, but not in the Group 1 Blanks)

A number of PAH analytes were found occasionally in the Group 2 Equipment Blanks, but not in the Group 1 Equipment Blanks: anthracene, 1-methylphenanthrene, benzo(k)fluoranthene, and perylene.

\*\*A number of PAH analytes were found consistently in the Group 2 Equipment Blanks, but only rarely (if at all) in the Group 1 Equipment Blanks: acenaphthene, acenaphthylene, fluoranthene, pyrene, chrysene, benzo(a)anthracene, benzo(b)fluoranthene, indeno(1,2,3-cd)pyrene, and benzo(ghi)perylene. Acenaphthene, acenaphthylene, chrysene, benzo(a)anthracene, and benzo(b)fluorethene were also found consistently and at similar levels in the Group 2 Method Blanks - see the above discussion under #5-Method Blanks; likewise for the other 4 PAH compounds in this group. This suggests that contamination of the Group 2 blanks and samples for these compounds is the result of laboratory practices (i.e. Method Blank contamination). However, additional site-specific review of the Method and Equipment Blank data is needed to evaluate why the Group 2 Equipment Blanks appear to be more contaminated than the Group 1 Blanks.

These general trends in the Equipment Blank data suggest an increase in contamination of the Group 2 sample data due to laboratory and/or equipment contamination. This is supported by a comparison of the "Mean Total PAH" in the Method and Equipment Blanks – see #3 above.

**SIT and USGS Field Blank Comparison:**

- (1) "Total Mean Field Blank PAH" was greatest for the USGS Field Blanks (191.9 ng/L), and was approximately twice that of the SIT Group 2 Field Blanks (73.5 ng/L) and SIT Group 1 Field Blanks (96.5 ng/L).
- (2) The largest Mean Field Blank (highlighted in grey) for each individual PAH analyte was consistently found in the USGS Field Blanks, with the exception of 2,3,5-trimethylnaphthalene, acenaphthylene, anthracene, benzo(a)pyrene, benzo(e)pyrene, and perylene. Except for acenaphthylene, which was found in 23 of the 32 SIT Group 2 Field Blanks, these PAH analytes were rarely (if ever) found in the SIT and USGS Field Blanks.
- (3) These differences in Mean Field Blank concentrations could be largely attributed to the way the field blanks were collected. The SIT Field Blanks were collected by opening the sample container and leaving it exposed to the ambient environment for the relatively short period of time (a few minutes) it took to collect the PAH grab sample. In contrast, the USGS Field Blanks consisted of open containers placed in the bottom of the ISCO sampler, and left exposed to the ambient environment for an extended period of time (hours), during which the USGS grab/composite PAH samples were collected.

	SIT Group 1 Mean FB	SIT Group 2 Mean FB	USGS Mean FB
Naphthalene	28.12	27.08	61.84
Biphenyl	7.20	2.72	7.84
Acenaphthene	2.60	1.00	4.37
1-Methylnaphthalene	6.26	6.07	14.67
2-Methylnaphthalene	9.51	11.68	29.01
2,6-Dimethylnaphthalene	6.73	2.14	6.24
2,3,5-Trimethylnaphthalene	0.00	0.50	0.00
Acenaphthylene	0.00	5.94	3.82
Fluorene	1.54	0.70	3.60
Anthracene	2.58	0.57	1.90
Phenanthrene	3.42	1.94	6.87
1-Methylphenanthrene	3.50	0.62	7.13
Fluoranthene	2.20	0.65	3.31
Pyrene	2.46	0.80	7.98
Chrysene	0.00	0.44	2.79
Benzo(a)anthracene	2.20	0.41	2.34
Benzo(b)fluoranthene	0.00	0.87	4.35
Benzo(k)fluoranthene	0.00	0.71	3.15
Benzo(a)pyrene	0.00	1.55	0.00
Benzo(e)pyrene	2.00	1.75	0.00
Dibenz(a,h)anthracene	3.77	1.39	6.91
Indeno(1,2,3-cd)pyrene	6.15	1.36	7.37
Perylene	0.00	1.56	0.00
Benzo(ghi)perylene	6.23	1.00	6.45
C2 Alkylnaphthalenes	9.89	9.22	31.60
C3 Alkylnaphthalenes	4.71	2.13	9.14
Total PAH ng/L	96.48	73.47	191.927

**SIT and USGS Method Blank Comparison:**

- (1) "Total Mean Method Blank PAH" was greatest for the SIT Group 2 Method Blanks (115.4 ng/L), which was approximately 10% larger than the USGS Method Blanks (104.6 ng/L) and 40% larger than the SIT Group 1 Method Blanks (87.7 ng/L).
- (2) The largest Mean Method Blank (highlighted in grey) for each individual PAH analyte was usually found in the SIT Group 1 (12) or Group 2 (9) blanks. The largest Mean Method Blank for 6 of the PAH analytes was found in the USGS blanks.
- (3) The SIT Group 2 Method Blanks (18 analytes were found in at least 4 of the 5 Method Blanks) appear to be more consistently contaminated than the SIT Group 1 (5 analytes were found in at least 6 of the 9 Method Blanks) and USGS Method Blanks (9 analytes were found in at least 5 of the 8 Method Blanks).
- (4) All of the Method Blanks were from the same analytical laboratory and, for the most part, were collected over the same time span. Thus, it is not surprising that the Method Blank data from the three groups of surveys are similar. However, the SIT Group 2 Methods Blanks appear to be more consistently contaminated by a larger number of the PAH compounds than the SIT Group 1 and USGS blanks.

	SIT Group 1 Mean MB	SIT Group 2 Mean MB	USGS Mean MB
Naphthalene	17.34	43.41	32.55
Biphenyl	10.00	3.53	3.64
Acenaphthene	2.50	1.48	1.93
1-Methylnaphthalene	8.42	10.07	9.30
2-Methylnaphthalene	11.34	20.03	18.05
2,6-Dimethylnaphthalene	8.13	3.33	6.37
2,3,5-Trimethylnaphthalene	6.10	0.00	6.10
Acenaphthylene	0.00	1.47	1.48
Fluorene	2.43	1.07	1.57
Anthracene	0.00	0.99	1.09
Phenanthrene	3.63	2.89	3.31
1-Methylphenanthrene	3.20	1.05	1.62
Fluoranthene	0.00	0.95	1.35
Pyrene	2.10	1.55	1.80
Chrysene	0.00	0.60	0.70
Benzo(a)anthracene	0.00	0.49	0.45
Benzo(b)fluoranthene	0.00	1.31	1.27
Benzo(k)fluoranthene	0.00	2.69	0.00
Benzo(a)pyrene	0.00	3.08	0.00
Benzo(e)pyrene	0.00	3.79	0.00
Dibenz(a,h)anthracene	3.93	3.71	3.37
Indeno(1,2,3-cd)pyrene	4.70	2.29	2.95
Perylene	0.00	3.68	3.50
Benzo(ghi)perylene	3.85	1.97	2.19
C2 Alkyl naphthalenes	20.95	12.79	21.17
C3 Alkyl naphthalenes	10.52	2.37	8.10
Total PAH ng/L	87.68	115.43	104.57

## **Questions & Conclusions**

Except for 2,3,5-trimethylnaphthalene, the “naphthalene group” of PAH compounds analyzed for in NJTRWP Studies I-D and I-E was consistently found in the various blanks. The consistent presence of these compounds at similar concentrations in the Field, Equipment, and Method Blanks suggests that the source(s) of this contamination is the analytical laboratory and/or the sampling equipment, and not “field activities”.

As discussed in the document “QA Issue: USGS Blank Contamination Problem”, two important questions to address are:

- (1) what compounds are consistently affected by blank contamination?
- (2) What samples are affected by blank contamination?

### ➤ **Question #1: what compounds are consistently affected by blank contamination?**

- For the Group 1 samples, only 4 PAH compounds were consistently found in all of the Group 1 Blanks: naphthalene, 2-methylnaphthalene, and the C2 and C3 alkylnaphthalenes; 1-methylnaphthalene and 2,6 di-methylnaphthalene were found in 3 of the 4 Equipment Blanks. Thus, it can be expected that most of the Group 1 samples have the potential to be potentially impacted by blank contamination impacts for these 6 analytes. Blank contamination impacts on the remaining 20 PAH analytes should be limited to sample or survey-specific situations.
- In contrast, for the Group 2 samples, only 5 PAH compounds were not consistently found in all of the Group 2 Blanks: 2,3,5-trimethylnaphthalene, anthracene, benzo(k)fluoranthene, benzo(a)pyrene, and perylene. Blank contamination impacts on these 5 PAH analytes should be limited to sample or survey-specific situations. However, it can be expected that most of the Group 2 samples have the potential to be potentially impacted by blank contamination impacts for the remaining 21 analytes.

### ➤ **Question #2: what samples are affected by blank contamination?**

- For the Group 1 samples, and focusing only on the 6 PAH analytes discussed under “Question #1” above: there were total of 37 Group 1 samples. Using the standard NJTRWP “5X Maximum Blank Approach”, the following analytes were impacted by blank contamination for the stated number of samples –
  - 2-methylnaphthalene = 37
  - naphthalene = 26
  - 1-methylnaphthalene = 26
  - C2 alkylnaphthalenes = 20
  - 2,6-dimethylnaphthalene = 18
  - C3 alkylnaphthalenes = 6

- There were a total of 32 Group 2 samples. Using the standard NJTRWP “5X Maximum Blank Approach”, and focusing on the 6 PAH analytes evaluated above for the Group 1 samples, the following analytes were impacted by blank contamination for the stated number of samples –

- 2-methylnaphthalene = 32
- naphthalene = 32
- 1-methylnaphthalene = 32
- 2,6-dimethylnaphthalene = 27
- C2 alkylnaphthalenes = 26
- C3 alkylnaphthalenes = 19

In addition to these 6 PAH analytes, the following compounds were frequently impacted by blank contamination in the Group 2 samples:

- Survey 2001-ID/EC1 (October 2001; 10 samples) –
  - biphenyl = 10
  - fluorene = 8
  - dibenz(a,h)anthracene = 7
  - acenaphthylene = 6
- Survey 2001-IDC2 (October 2001; 2 samples) –
  - Useable data is only available in at least 1 sample for anthracene, fluoranthene, benzo(k)fluoranthene, benzo(e)pyrene, pyrene, 1-methylphenanthrene, chrysene.
- Survey 2001-IEC3/IDB3 (November 2001; 5 samples) –
  - Useable data is only available in at least 1 sample for anthracene, fluoranthene, benzo(a)anthracene, pyrene, chrysene.
- Survey 2002-ID/EA1 (March 2002; 10 samples) –
  - acenaphthylene = 9
  - biphenyl = 8
  - fluorene = 7
- Survey 2002-IDA2 (March 2002; 2 samples) –
  - acenaphthene = 2
  - acenaphthylene = 2
  - biphenyl = 2
  - fluorene = 2
  - 1-methylphenanthrene = 2
  - dibenz(a,h)anthracene = 2
- Survey 2002-ID/EA3 (May 2002; 3 samples) –
  - biphenyl = 3

In summary, the following analytes are consistently impacted by blank contamination in the 32 Group 2 samples, with the number of samples impacted listed in parentheses:

- 2-methylnaphthalene (32)
- naphthalene (32)
- 1-methylnaphthalene (32)
- biphenyl (30)
- 2,6-dimethylnaphthalene (27)
- C2 alkylnaphthalenes (26)
- fluorene (24)
- acenaphthylene (24)
- C3 alkylnaphthalenes (19)
- dibenz(a,h)anthracene (16)

NJ Toxics Reduction Workplan for NY-NJ Harbor:  
Data Integration - Water Quality and Hydrodynamics

Final Report

Submitted to

New Jersey Department of Environmental Protection  
Division of Science, Research and Technology

By

Nadia Dimou  
Dept of Civil, Environmental and Ocean Engineering  
Stevens Institute of Technology  
Castle Point on Hudson  
Hoboken, NJ 07030

August 17, 2006

## TABLE OF CONTENTS

<b>1. INTRODUCTION / OBJECTIVES .....</b>	<b>5</b>
<b>2. SAMPLING STRATEGY .....</b>	<b>6</b>
<b>3. METHODOLOGY .....</b>	<b>8</b>
<b>4. RESULTS .....</b>	<b>10</b>
4.1 Correlations between SS, carbon, and toxics (total Hg, total PCDD/F, and 2,3,7,8-TCDD) .....	23
4.2 Dependence of SS and carbon data on the phase of the tide .....	28
4.2.1 Passaic River .....	28
4.2.2 Hackensack River .....	33
4.2.3 Newark Bay .....	38
4.2.4 Elizabeth River .....	42
4.2.5 Rahway River .....	44
4.3 Dependence of Total PCDD/F and 2,3,7,8 TCDD data on the maximum tidal elevation .....	46
4.4 Dependence of Total Hg on the max tidal elevation .....	50
<b>5. SUMMARY AND CONCLUSIONS .....</b>	<b>53</b>



## TABLES

Table 1 Hydrodynamic data (June 2000, December 2000 Surveys) .....	11
Table 2: SS, DOC and POC data (June 2000, December 2000 Surveys).....	15
Table 3: Total Hg, Total PCDD/F and 2,3,7,8-TCDD data (June 2000, December 2000 Surveys) .....	<a href="#">22</a>

## FIGURES

Figure 1: Approximate locations of the NJTRWP sampling stations.....	7
Figure 2: Schematic Diagram of the Stevens Modified TOPS (SIT-TOPS) .....	9
Figure 3: Linear Regression Analysis between SS and Total Hg (ng/L).....	23
Figure 4: Linear Regression Analysis between SS and Total Hg (ng/g) .....	24
Figure 5: Linear Regression Analysis between POC and Total Hg (ng/g).....	24
Figure 6: Linear Regression Analysis between SS and Total PCDD/F (pg/L).....	25
Figure 7: Linear Regression Analysis between SS and Total PCDD/F (pg/g).....	25
Figure 8: Linear Regression Analysis between POC and Total PCDD/F (pg/L) .....	26
Figure 9: Linear Regression Analysis between POC and Total PCDD/F (pg/g).....	26
Figure 10: Linear Regression Analysis between SS and 2,3,7,8 TCDD (pg/g).....	27
Figure 11: Linear Regression Analysis between POC and 2,3,7,8 TCDD (pg/g) .....	27
Figure 12: (a) SS, (b) DOC and (c) POC measurements at the PAS1 sampling station...	29
Figure 13: (a) SS, (b) DOC and (c) POC measurements at the PAS2 sampling station...	31
Figure 14: (a) SS, (b) DOC and (c) POC measurements at the PAS3 sampling station...	32
Figure 15: (a) SS, (b) DOC and (c) POC measurements at the HAC1 sampling station..	34
Figure 16: (a) SS, (b) DOC and (c) POC measurements at the HAC2 sampling station..	36
Figure 17: (a) SS, (b) DOC and (c) POC measurements at the HAC3 sampling station..	<a href="#">41</a>
Figure 18: (a) SS, (b) DOC and (c) POC measurements at the NB1-S sampling station.	39
Figure 19: (a) SS, (b) DOC and (c) POC measurements at the NB1-D sampling station	40
Figure 20: (a) SS, (b) DOC and (c) POC measurements at the NB3 sampling station ....	42
Figure 21: (a) SS, (b) DOC and (c) POC measurements at the ELIZ sampling station ...	44
Figure 22: (a) SS, (b) DOC and (c) POC measurements at the RWY1 sampling station.	45
Figure 23: (a) Total PCDD/F, and (b) 2,3,7,8 TCDD measurements vs maximum tidal elevation at the Passaic River sampling stations.....	<a href="#">51</a>
Figure 24: (a) Total PCDD/F, and (b) 2,3,7,8 TCDD measurements vs maximum tidal elevation at the Hackensack River sampling stations .....	48
Figure 25: (a) Total PCDD/F, and (b) 2,3,7,8 TCDD measurements vs maximum tidal elevation at the Newark Bay sampling stations .....	49
Figure 26: (a) Total PCDD/F, and (b) 2,3,7,8 TCDD measurements vs maximum tidal elevation at the AK1-S, ELIZ, and RWY1 sampling stations .....	50
Figure 27: Total Suspended Hg (ng/g) measurements vs maximum tidal elevation at the Passaic River sampling stations .....	51
Figure 28: Total Suspended Hg (ng/g) measurements vs maximum tidal elevation at the Hackensack River sampling stations .....	51
Figure 29: Total Suspended Hg (ng/g) measurements vs maximum tidal elevation at the Newark Bay sampling stations.....	52
Figure 30: Total Suspended Hg (ng/g) measurements vs maximum tidal elevation at the AK1-S, ELIZ, and RWY1 sampling stations.....	52



## 1. INTRODUCTION / OBJECTIVES

The New York-New Jersey Harbor estuary system is of enormous and interdependent ecological and economic importance. However, the presence of toxic chemicals in the water and sediments results in reduced water quality, fisheries restrictions/advisories, reproductive impairments in some species, and general adverse impacts to the estuarine and coastal ecosystems. The Port of New York and New Jersey is the largest port on the East Coast of the United States and central to the economy of the region. However, problems associated with the management of contaminated dredged material, including high costs and the lack of suitable disposal/use alternatives, have resulted in uncertainty regarding construction and future maintenance of the maritime infrastructure that supports shipping in the harbor.

The New Jersey Toxics Reduction Workplan for NY-NJ Harbor (NJTRWP) includes a series of studies designed to provide the NJ Department of Environmental Protection (NJDEP) with the data and information it needs to meet the following primary objectives:

- to identify sources of the toxic chemicals of concern, and to prioritize these sources for appropriate action (management, regulatory, trackdown, clean-up).
- to identify selected contaminated sediments for future remediation and restoration activities.

As part of the NJTRWP, Stevens Institute of Technology conducted hydrodynamic studies and water and suspended sediment quality monitoring in the tidal reaches of the major tributaries to the NY-NJ Harbor Estuary (Study I-D), and in the estuarine areas of Newark Bay, the Arthur Kill, and the Kill van Kull (Study I-E).

The primary goal of NJTRWP Studies I-D and I-E is to determine the relative importance of discharges of suspended sediment and selected organic and inorganic contaminants originating within the watersheds of the major tributaries to the Newark Bay Complex, the Arthur Kill, the Kill van Kull, and Raritan Bay. These discharges represent the loadings of sediment and the chemicals of concern from all sources that enter the tidal portions of these tributaries and estuarine areas.

These studies have provided the data and information needed to identify those tributaries to, and estuarine areas within, NY-NJ Harbor that are significant sources of the toxic chemicals of concern. The Project Report of Studies I-D and I-E of the NJTRWP documents the methods, results, analyses, and conclusions of the water and suspended sediment quality monitoring components.

The objective of the present work is to visually identify the potential interactions between the hydrodynamic data (i.e., currents, water levels, salinity) and the water quality data. Total mercury (Hg) and 2,3,7,8-TCDD (the most toxic dioxin/furan [PCDD/F] congener) are chosen as the water quality parameters of interest, because these contaminants are largely bound to suspended particulates. Thus, their concentrations would be expected to be strongly associated with suspended particulate levels and affected by the

hydrodynamic forces that move suspended particulates throughout the harbor. This study was designed to use the entire NJTRWP Study I-D/E water quality data set in conjunction with selected Study I-E hydrodynamic measurements to evaluate the following hypotheses:

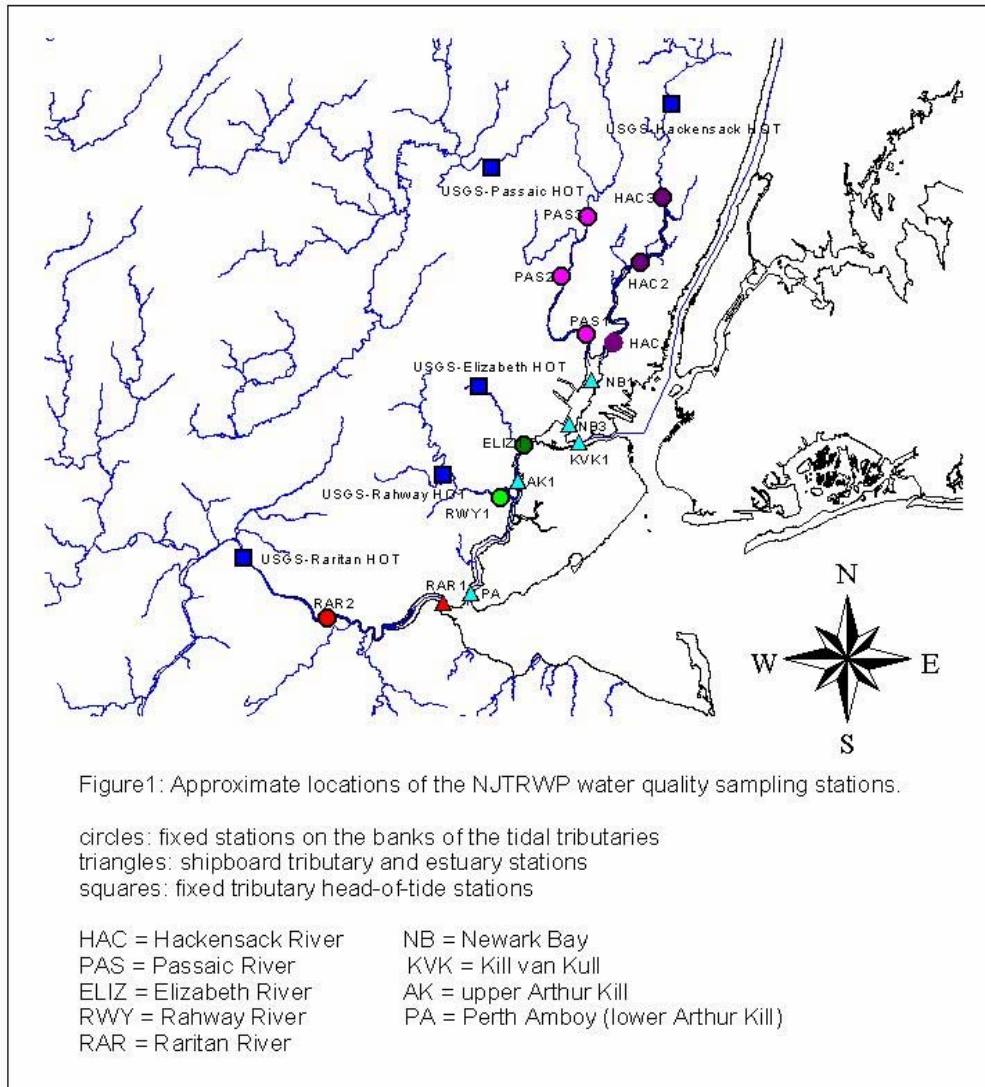
- 1) The concentrations of toxic contaminants (specifically Hg, PCDD/F, and 2,3,7,8-TCDD) are correlated with SS, POC, and DOC levels;
- 2) The observed levels of SS and POC will vary in a consistent manner over the course of the tidal cycle;
- 3) The observed levels of SS and POC will vary in a consistent manner in response to storm/river flow conditions;
- 4) The concentrations of toxic contaminants (specifically Hg, PCDD/F, and 2,3,7,8-TCDD) are correlated with tidal currents (using maximum tidal height during each sampling event as a proxy).

## **2. SAMPLING STRATEGY**

The NJ Toxics Reduction Workplan for NY-NJ Harbor ambient water quality sampling program (water and suspended sediment quality measurements using SIT-TOPS and grab sampling techniques) used five fixed river head-of-tide locations (not discussed in this study), ten fixed sampling sites located along the banks of the tidally influenced part of the tributary rivers, and five shipboard estuary locations (Figure 1). The study area has been divided into two major survey areas:

- the Northern Tributaries, i.e. the Hackensack and Passaic Rivers, Newark Bay, and the Kill van Kull; and
- the Southern Tributaries, i.e. the Elizabeth, Rahway, and Raritan Rivers, and the Arthur Kill

This study presents data from sampling surveys conducted between June 2000 and May 2002.



**Figure 1:** Approximate locations of the NJTRWP sampling stations.

### 3. METHODOLOGY

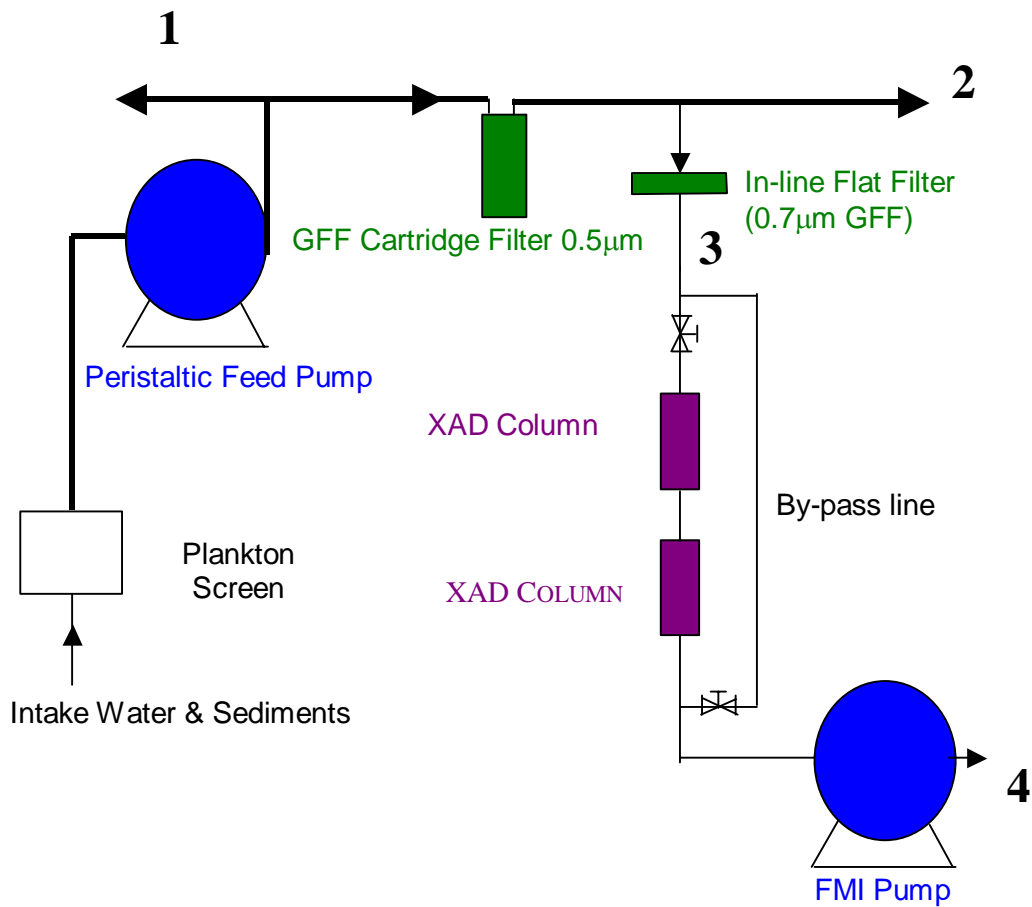
Ambient water quality monitoring was performed using SIT-TOPS sampler units. A schematic of the SIT-TOPS units is shown in Figure 2. Each SIT-TOPS unit is equipped with two types of filters and two XAD-resin columns in series:

- A baked 4-inch long, 0.5  $\mu\text{m}$  nominal size retention Cartridge GFF filter (C-GFF) located in the discharge line of the peristaltic pump right after sampling port 1;
- A 142-mm diameter in-line 0.7  $\mu\text{m}$  GF/F Whatman glass microfiber filter (“flat filter”) located before the XAD columns.

Two XAD-resin columns are connected in series between the in-line flat filter and the FMI pump. Each column contained approximately 125 grams of pre-cleaned Supelco Amberlite XAD Type 2 resin, supplied as 20-60 mesh-size beads.

A minimum of 50 liters of water must flow through the XAD columns to insure that sufficient mass of the organic compounds of interest will be trapped in these columns. The peristaltic feed pump flow rate is set at approximately 2000 ml/min. The flow rate of the FMI pump is restricted by breakthrough and is set at approximately 250 ml/min and is monitored every thirty minutes. The inline filters are replaced as needed in order to maintain the flow rate in the FMI line above the 200 ml/min threshold value. Based on the above considerations, the duration of the sampling event is at least four hours.

At the tidal tributary and estuary sites, each SIT-TOPS sampling event began approximately at high tide and had a duration of at least four hours. The tributaries were sampled during two storm (wet) events and two low-flow discharge (dry) events. The wet weather river flow (storm) magnitude scale has been developed by USGS using data for the last 25 years of record for each river. Ambient water was continuously pumped through the SIT-TOPS during this sampling period. In addition, aqueous samples were taken at hourly intervals through the sampling ports at the intake, waste line, after the in-line flat filter, and after the XAD columns, and analyzed for suspended sediments (SS), particulate organic carbon (POC), and dissolved organic carbon (DOC). Dissolved phase organics were eluted from the XAD columns. Particulate phase organics were extracted from the set of SIT-TOPS filters. The samples were usually collected at a depth of 1.5m below the water surface. In order to obtain a vertical profile at selected locations, samples were also collected at a depth of 1.5m above the river/estuary bottom (in order to avoid sampling bottom sediments); these are noted with a “D” suffix (for example, NB1-D) to distinguish them from the surface samples (for example, NB1-S).



### Sampling Ports

1. Intake. Water Sampling port for Metals, PAHs, SS, POC and DOC
2. Waste line. Sampling for SS, POC and DOC
3. Post in-line filter. Sampling for SS, POC and DOC via by-pass line through port 4
4. Post XAD columns. Sampling port for SS, POC and DOC

**Figure 2:** Schematic Diagram of the Stevens Modified TOPS (SIT-TOPS)

#### **4. RESULTS**

Tables 1, 2, and 3 present hydrodynamic (tide, maximum elevation, maximum velocity, salinity) and water quality data (SS, POC, DOC, total Hg, total PCDD/F, 2,3,7,8-TCDD) at all of the sampling stations during all of the sampling events.

Water level data from the Passaic Valley Sewage Commissioners station (PVSC, located at the confluence of the Passaic River, Hackensack River and Newark Bay) were used to specify the maximum tidal elevation in the Northern Tributaries (i.e. the Hackensack and Passaic Rivers, and Newark Bay). For sampling stations in the Southern Tributaries (i.e. the Elizabeth, Rahway, and Raritan Rivers, and Arthur Kill) water level data from the Constable Hook (Perth Amboy) station were used.



**Table 1** Hydrodynamic data (June 2000, December 2000 Surveys)

Date Sampled	Station	Time of High Tide	Time of Low Tide	Time Sampling Started	Time Sampling Ended	Time Sampling Started - High Tide <sup>1</sup>	Max.	Time max	Max	Time max	Max	Time max
							Elevation (referenced to MSL) (m)	elevation occurred GMT	Velocity (depth-avgd) (m/s)	velocity occurred GMT	Bottom Salinity (psu)	salinity occurred GMT
06/21/00	HAC1	06:48	12:48	14:53	17:54	08:05	No data	No data	No data	No data	No data	No data
06/21/00	PAS1	06:10	12:10	12:58	17:54	06:48	No data	No data	No data	No data	No data	No data
06/20/00	NB001-S	05:28	11:28	16:24	19:30	10:56	No data	No data	No data	No data	No data	No data
06/20/00	NB001-D	05:28	11:28	15:53	18:25	10:25	No data	No data	No data	No data	No data	No data
06/22/00	NB001-S	06:41	12:41	12:30	16:42	05:49	No data	No data	No data	No data	No data	No data
06/22/00	NB001-D	06:41	12:41	12:30	13:30	05:49	No data	No data	No data	No data	No data	No data
12/13/00	HAC1	10:00	16:00	09:28	15:15	00:32	No data	No data	No data	No data	No data	No data
12/13/00	HAC2	10:05	16:05	11:30	18:09	01:25	No data	No data	No data	No data	No data	No data
12/14/00	HAC3	11:52	17:52	12:10	17:35	00:18	No data	No data	No data	No data	No data	No data
12/15/00	PAS1	11:17	17:17	10:40	17:28	00:37	No data	No data	No data	No data	No data	No data
12/15/00	PAS2	11:20	17:20	09:10	15:55	02:10	No data	No data	No data	No data	No data	No data
12/15/00	PAS3	11:21	17:21	10:15	15:00	01:06	No data	No data	No data	No data	No data	No data
12/14/00	AK1-S	10:08	16:08	11:40	16:17	01:32	0.32	0.625	0.52	0.583333	21.8	0.625
12/14/00	PA-S	09:58	15:58	12:04	15:37	02:06	No data	No data	No data	No data	No data	No data
12/13/00	KVK001	09:08	15:08	13:00	16:52	03:52	0.71	0.625	0.99	0.458333	22.77	0.416667
12/14/00	NB001-S	11:11	17:11	11:59	16:20	00:48	0.81	0.708333	0.44	0.583333	22.08	0.708333
12/15/00	NB001-D	11:11	17:11	11:33	15:52	00:22	0.81	0.708333	0.44	0.583333	22.08	0.708333
12/15/00	NB003	11:04	17:04	11:09	14:12	00:05	No data	No data	No data	No data	No data	No data

<sup>1</sup> Absolute value of the difference between “Time Sampling Started” and “Time of High Tide”







**Table 2:** SS, DOC and POC data (June 2000, December 2000 Surveys)

Station IDs	Date Sampled	SS	SS	SS	SS	SS	SS geom.	DOC	DOC	DOC	DOC	DOC	DOC	DOC	DOC	DOC	DOC	DOC	DOC			
		(t=0)	(t=1)	(t=2)	(t=3)	(t=4)	Mean	(t=1)	(t=2)	(t=3)	(t=4)	Mean	(t=1)	(t=2)	(t=3)	(t=4)	Mean	(t=1)	(t=2)	(t=3)	(t=4)	Mean
		mg/L	mg/L	mg/L	mg/L	mg/L	mg/L	mg/L	mg/L	mg/L	mg/L	mg/L	mg/L	mg/L	mg/L	mg/L	mg/L	mg/L	mg/L	mg/L	mg/L	mg/L
HAC1	06/21/00		22.4	25.6	28.4	26.1	25.53	2.933	3.333	4.961	4.367	3.81	0.878	0.97	1.453	1.187	1.10					
PAS-1	06/21/00		26.5	140.7	34.2	30.4	44.37	3.532	3.999	4.376	5.261	4.25	2.537	3.3	2.946	2.087	2.68					
NB001-S	06/20/00		15	13.1	10.5	11.8	12.49	3.789	4.832	4.881	4.507	4.48	0.834	0.79	0.801	0.758	0.80					
NB001-D	06/20/00		24.2	23.6	17.5		21.54	2.333	2.545	4.403		2.97	0.409	1.356	0.49		0.65					
NB001-S	06/22/00		8	7.1	8.4	6.5	7.46															
NB001-D	06/22/00							2.761	2.955	4.071	4.051	3.41	0.517	0.762	0.497	0.57	0.58					
HAC1	12/13/00	23.3	19.5	47	45.3	29.5	33.27	2.554	3.048	3.033	3.459	3.01	1.306	5.461		1.039	1.95					
HAC2	12/13/00	27.5	24.7	33	26	28	27.75	5.644	5.931	5.725	6.608	5.97	1.837	1.743	1.786	1.721	1.77					
HAC3	12/14/00	34.8	73.6	81.8	79.6	78.2	78.24	7.031	7.324	6.626	5.641	6.62	4.168	4.882	4.883	4.759	4.66					
PAS1	12/15/00	28.4	20.2	27.9	62	57.5	37.65	2.451	2.416	3.145	3.674	2.88	1.008	1.409	4.083	3.427	2.11					
PAS2	12/15/00	60.4	43.2	35.4	69.8	72.4	52.73	3.751	3.988	3.667	3.536	3.73	2.904	2.693	5.102	3.36	3.40					
PAS3	12/15/00	6.1	6.7	5.2	4.8	4.3	5.18	3.346	3.678	4.082	3.576	3.66	1.305	1.099	1.156	0.906	1.11					
AK1-S	12/14/00	11.4	12.5	14.6	18.8	14.4	14.91	2.74	2.84	2.818	2.718	2.78	0.475	1.118	0.771		0.74					
PA-S	12/14/00	6.2	12.7	8.8	7.2		9.30	1.81	1.889	2.205		1.96	0.452	0.479	0.548		0.49					
KVK001	12/13/00	13	12.9	15.2	10.8		12.84	2.905	2.714	2.655		2.76	0.767	0.618	0.75		0.71					
NB001-S	12/14/00	7	7.4	13.7	25.3		13.69		2.793	2.956		2.87		1.274	0.915		1.08					
NB001-D	12/15/00	14	12.9	15.8	32.3		18.74	2.05	2.056	2.166		2.09	0.645	0.755	1.319		0.86					
NB003	12/15/00	5.1	5	10.5	5.3		6.53	2.513	1.962	3.108		2.48	0.59	0.486	0.496		0.52					

**Table 2 (continued): SS, DOC and POC data (March 2001, April 2001, May 2001 Surveys)**

Station IDs	Date Sampled	SS	SS	SS	SS	SS	SS geom.	DOC	DOC	DOC	DOC	DOC	DOC	DOC	DOC	DOC	DOC	DOC
		(t=0)	(t=1)	(t=2)	(t=3)	(t=4)	Mean	(t=1)	(t=2)	(t=3)	(t=4)	Mean	(t=1)	(t=2)	(t=3)	(t=4)	Mean	
		mg/L	mg/L	mg/L	mg/L	mg/L	mg/L	mg/L	mg/L	mg/L	mg/L	mg/L	mg/L	mg/L	mg/L	mg/L	mg/L	mg/L
HAC1	03/13/01	10.5	6.2	9.7	15	12.3	10.26	3.213	3.14	3.047	6.066	3.70	0.391	0.418	0.366	0.441	0.40	
HAC2	03/13/01	24.2	12.6	9.2	12.1	18	12.61	6.598	6.185	7.064	7.961	6.92	0.816	0.787	0.764	1.296	0.89	
HAC3	03/13/01	32.3	44.8	22.8	51.9	30.2	35.57	6.973	7.171	6.039	6.759	6.72	2.159	1.663	3.782	4.301	2.76	
PAS-1	03/15/01	11.4	8.1	6.7	8.1	40.8	11.57	4.4	3.939	4.38	5.078	4.43	0.699	0.372	0.762	0.842	0.64	
PAS-2a	03/15/01	9.9	6	6.1	7.6	8.7	7.01	4.91	5.552	5.966	8.847	6.16	0.302	0.433	0.554	0.932	0.51	
PAS-3	03/15/01	5.1	4.7	3.1	4.6	4.2	4.10	3.58	4.312	5.022	5.215	4.48	0.56	0.744	0.657	0.645	0.65	
AK1-S	03/14/01	10.8	11.9	10.7	8.4	12.5	10.75	3.72	4.627	3.744	3.306	3.82	0.59	0.589	0.219	0.511	0.44	
PA-S	03/14/01	11.8	10.1	16.8	13.3	12.6	12.99	3.735	5.235	4.543	2.593	3.90	1.37	1.178	1.38	0.771	1.14	
KVK001	03/13/01	9.2	11	11.1	9.9	9.9	10.46	10.774	3.586	3.154	4.248	4.77	0.291	0.331	0.283	0.227	0.28	
NB001-S	03/15/01	7.5	7.3	6	6.3		6.51	4.24	3.73	5.308		4.38	0.882	0.57	0.593		0.67	
NB001-D	03/15/01	15.1	8	11	9.9		9.55	2.932	2.25	7.092		3.60	0.425	0.368	0.317		0.37	
NB003	03/15/01	8.9	7.7	6.4	10	11.2	8.62	5.056	2.672	6.076	3.856	4.22	0.295	0.284	0.249	0.311	0.28	
RAR1-S	04/12/01	8.5	10.2	12.9	23.8	22.2	16.24	3.495	4.16	4.145	3.679	3.86	0.822	0.851	1.274	0.904	0.95	
RAR2	04/12/01	14.3	8.7	9.2	9.7	9.8	9.34	3.174	3.411	3.68	3.326	3.39	0.447	0.475	0.554	0.759	0.55	
ELIZ1	04/25/01	8.5	74.3	2.2	4	4.9	7.52	2.328	3.061	3.6	4.053	3.19	0.868	0.472	1.138	0.58	0.72	
RHWY1	04/25/01	11.4	9	13.6	16.2	17.5	13.65	5.585	5.381	4.639	4.493	5.00	0.755	0.646	1.462	1.656	1.04	
AK1-D	04/25/01	6.8	5.7	8.8	7.6	11.9	8.21	2.754	2.515	2.132	4.243	2.81	1.833	0.393	0.323	0.273	0.50	
PA-D	04/25/01	15.8	10.2	16.1	14.4	8.8	12.01	2.749	2.552	3.401	2.97	2.90	1.241	1.592	1.671	1.519	1.50	
RAR1-S	05/15/01	6.8	4.6	3.2	4.2	5.3	4.25	2.811	2.793	2.786	3.959	3.05	0.695	0.7	0.714	0.706	0.70	
RAR-2	05/15/01	15.6	9.7	8.8	6.6	7.5	8.06	5.254	5.149	4.925	5.753	5.26	0.618	0.759	1.169	0.968	0.85	

**Table 2 (continued):** SS, DOC and POC data (May 2001, October 2001 Surveys)

Station IDs	Date Sampled	SS	SS	SS	SS	SS	SS geom.	DOC	DOC	DOC	DOC	DOC	DOC	DOC	DOC	DOC	DOC	DOC
		(t=0)	(t=1)	(t=2)	(t=3)	(t=4)	Mean	(t=1)	(t=2)	(t=3)	(t=4)	Mean	(t=1)	(t=2)	(t=3)	(t=4)	Mean	
		mg/L	mg/L	mg/L	mg/L	mg/L	mg/L	mg/L	mg/L	mg/L	mg/L	mg/L	mg/L	mg/L	mg/L	mg/L	mg/L	mg/L
ELIZ1	05/22/01	33	45	44.4	34.7	7.2	26.58	5.698	5.833	5.753	3.375	5.04	5.166	5.322	2.154	0.566	2.41	
RHWY1	05/22/01	36.3	127.2	214.8	185.8	148.1	165.59	5.658	5.3	4.855	5.092	5.22	5.166	5.322	2.154	0.566	2.41	
AK1-D	05/22/01	10.2	5.7	17.5	7.4	9	9.03	2.79	2.728	2.782	2.45	2.68	0.495	1.216	0.362	0.315	0.51	
PA-S	05/22/01	12.5	7.8	7.3	15.7	14.9	10.74	3.856	2.939	2.966	4.474	3.50	1.28	0.776	0.602	0.484	0.73	
PA-D	05/22/01	10	14.1	18.5	18.7	13.4	15.99	2.028	2.734	2.156	2.482	2.33	0.837	0.472	0.709	0.48	0.61	
HAC1	10/17/01	10.1	14.3	8.9	45.3	56.1	23.85	3.786	3.878	4.193	4.378	4.05	0.12	0.39	0.592	0.821	0.39	
HAC2	10/17/01	24.1	26	37.7	26.7	39.2	31.83	6.68	6.89	6.312	7.332	6.79	0.964	0.573	0.579	0.903	0.73	
HAC3	10/17/01	32.1	18.9	8.2	55.8	158.7	34.23	7.512	7.454	7.213	7.62	7.45	4.131	2.349	13.081	8.002	5.65	
PAS1	10/19/01	36.7	36.4	58.9	106.3	97.4	68.64	4.126	4.396	5.108	4.726	4.57	0.18	0.167	0.61	0.162	0.23	
PAS2a	10/19/01	100.2	27.5	33	68.6	52.2	42.46	5.628	5.888	5.896	5.414	5.70	1.048	0.89	1.317	2.198	1.28	
PAS3	10/19/01	57.4	25.3	42.6	43.7	49.1	39.00	5.615	5.035	5.756	5.915	5.57	1.155	0.736	0.756	1.675	1.02	
NB001-S	10/19/01	6.7	6	29.3	28.8	39.5	21.15	3.584	4.351	4.424	4.798	4.27	0.12	0.132	0.533	0.639	0.27	
NB001-D	10/19/01	8.1	8.6	18.4	13.6	17	13.83	3.658	2.99	3.832	3.702	3.53	0.153	0.305	0.516	0.406	0.31	
NB003	10/19/01	19.1	12.5	12.4	8.3	6.9	9.71	3.094	3.609	4.71	4.495	3.92	0.374	0.27	0.291	0.203	0.28	
KVK001	10/17/01	9.7	14.9	23.5	12.2	13.2	15.41	2.863	3.311	2.942	2.951	3.01	0.518	0.49	0.253	0.329	0.38	
RAR1-S	10/03/01	3.6	3.1	2.3	2.6	4.9	3.09	4.783	5.866	5.325	4.472	5.08	0.21	0.312	0.216	0.259	0.25	
RAR2	10/03/01	16	14.6	14.2	14.7	9.3	12.98	5.012	4.865	4.947	4.596	4.85	0.161	0.178	0.211	0.177	0.18	

**Table 2 (continued):** SS, DOC and POC data (November 2001, March 2002, May 2002 Surveys)

Station IDs	Date Sampled	SS	SS	SS	SS	SS	SS geom.	DOC	DOC	DOC	DOC	DOC	POC	POC	POC	POC	POC	
		(t=0)	(t=1)	(t=2)	(t=3)	(t=4)	Mean	(t=1)	(t=2)	(t=3)	(t=4)	geom. Mean	(t=1)	(t=2)	(t=3)	(t=4)	Mean	
		mg/L	mg/L	mg/L	mg/L	mg/L	mg/L	mg/L	mg/L	mg/L	mg/L	mg/L	mg/L	mg/L	mg/L	mg/L	mg/L	mg/L
ELIZ1	11/06/01	5.6	2.3	2.2	3.3	2.6	2.57	2.589	2.307	2.363	2.117	2.34	0.157	0.133	0.223	0.209	0.18	
RWY1	11/06/01	5.6	5.6	3.7	4.2	9.2	5.32	3.145	3.901	4.599	4.545	4.00	0.261	0.33	0.436	0.612	0.39	
AK1-D	11/06/01	4.3	8.3	5.8	5.1	5.6	6.09	2.219	2.905	2.433	2.641	2.54	0.191	0.266	0.16	0.243	0.21	
PA-S	11/06/01	5.7	5.9	3.7	3.8	4.6	4.42	2.551	2.503	2.614	2.624	2.57	0.381	0.38	0.308	0.429	0.37	
PA-D	11/06/01	4.6	2.5	1.6	4.6	5.6	3.19	2.309	2.244	2.342	2.909	2.44	0.322	0.294	0.358	0.352	0.33	
HAC1	03/14/02	8.1	2.7	3.8	4	6	3.96	2.757	2.832	3.037	3.453	3.01	0.576	0.563	0.641	0.766	0.63	
HAC2	03/14/02	10.4	8.3	6	8.8	4	6.47	6.704	6.492	6.573	7.271	6.75	1.076	1.14	1.478	1.578	1.30	
HAC3	03/14/02	34.7	16.7	53	40.6	34	33.25	9.4	9.08	9.659	9.327	9.36	1.355	1.298	1.026	0.97	1.15	
PAS-1	03/12/02	18.5	5.6	11.1	13.2	12.2	10.00	6.205	5.758	5.614	5.481	5.76	0.851	1.701	1.119	1.326	1.21	
PAS-2a	03/12/02	113.7	19.4	23.9	31.5	32.7	26.29	6.056	6.166	6.432	6.333	6.25	2.347	2.741	3.054	3.294	2.84	
PAS-3	03/12/02	23.5	18.3	16.3	16.6	20.6	17.87	6.944	6.81	6.798	6.907	6.86	1.568	2.362	2.562	2.346	2.17	
NB001-S	03/13/02	4.9	4.6	3.5	5.2	5	4.52	5.596	5.238	4.85	5.23	5.22	0.518	0.755	0.805	0.728	0.69	
NB001-D	03/13/02	3.4	3.1	3.6	10.7	12.3	6.19	2.629	2.354	3.045	2.973	2.74	0.547	0.585	0.946	0.841	0.71	
NB003	03/13/02	8.5	5.3	6.8	4.6	4.8	5.31	2.297	2.085	2.25	2.336	2.24	0.517	0.554	0.539	0.63	0.56	
KVK001	03/14/02	4	26.1	4.9	6	6.3	8.34	2.61	1.789	2.581	2.549	2.35	0.557	0.421	0.408	0.386	0.44	
RAR1-S	03/27/02	6.6	11.1	16.7	17.6	17.1	15.37	2.658	2.702	2.956	3.156	2.86	1.657	1.733	2.234	1.432	1.74	
RAR-2	03/27/02	11	8.1	9	12.4	10.7	9.92	4.903	4.517	4.604	4.475	4.62	0.657	0.763	1.036	0.74	0.79	
ELIZ1	05/14/02	6.8	7.3	7	6.7	6.9	6.97	2.626	3.23	3.539	3.429	3.19	0.379	0.756	0.722	0.763	0.63	
RWY1	05/14/02	53.6	105.6	107.6	43.8	71.9	77.34	4.655	4.684	4.971	4.513	4.70	2.079	3.291	2.125	2.274	2.40	
AK1-S	05/14/02		6.8	8.1	7.4	11.9	8.35	2.581	2.605	2.309	2.468	2.49	0.587	0.665	0.541	0.407	0.54	



**Table 3: Total Hg, Total PCDD/F and 2,3,7,8-TCDD data (June 2000, December 2000 Surveys)**

Station IDs	Date Sampled	Hg		Total PCDD/F		Total 2,3,7,8 TCDD
		Total Suspended Hg	Total Sediment	PCDD/F	PCDD/F	Total 2,3,7,8 TCDD
		ng/L	ng/g	pg/L	pg/g	pg/g
HAC1	06/21/00	51.6	2283	222	10131	150
PAS-1	06/21/00	43	1589	478	12267	433
NB001-S	06/20/00					
NB001-D	06/20/00					
NB001-S	06/22/00	6.41	362	121	11715	202
NB001-D	06/22/00	74.2	3045	144	12985	210
HAC1	12/13/00	62.2	2631	11	378	2
HAC2	12/13/00	93.3	3338	26	1511	14
HAC3	12/14/00	127	3579	57	1103	6
PAS1	12/15/00	68.6	2415	41	1273	25
PAS2	12/15/00					
PAS3	12/15/00	22.6	3506	17	7137	20
AK1-S	12/14/00	77.5	6790	34	2358	12
PA-S	12/14/00	12.8	2021	16	1756	3
KVK001	12/13/00	28.8	2215	23	1834	11
NB001-S	12/14/00	23.6	3357	27	2439	23
NB001-D	12/15/00	38.4	2675	16	945	6
NB003	12/15/00	19.2	3588	14	2289	18

**Table 3 (continued): Total Hg, Total PCDD/F and 2,3,7,8-TCDD data (March 2001, April 2001, May 2001 Surveys)**

Station IDs	Date Sampled	Hg				Total 2,3,7,8 TCDD
		Total Hg ng/L	Suspended Sediment ng/g	Total PCDD/F pg/L	Total PCDD/F pg/g	
HAC1	03/13/01	19.5	1905	117	12850	109
HAC2	03/13/01	75.8	3081	76	7717	62
HAC3	03/13/01	124	3805	236	9132	41
PAS-1	03/15/01	23.1	1921	113	11990	409
PAS-2a	03/15/01	18.7	1799	82	17229	185
PAS-3	03/15/01	7.64	1355	12	6487	
AK1-S	03/14/01	17.2	1574	78	7528	27
PA-S	03/14/01	11.7	1017	169	13639	28
KVK001	03/13/01	18.4	2000	60	5785	33
NB001-S	03/15/01	10.8	1467	46	7511	47
NB001-D	03/15/01	18.6	1258	47	5202	34
NB003	03/15/01	11.9	1348	35	4294	26
RAR1-S	04/12/01	17.2	1912	200	13818	6
RAR2	04/12/01	8.16	411	245	39803	
ELIZ1	04/25/01	22.4	2547	312	43245	147
RHWY1	04/25/01	33.6	2921	198	17307	26
AK1-D	04/25/01	23.4	3393	99	12273	43
PA-D	04/25/01	38.1	2411	75	13039	39
RAR1-S	5/15/01	16.5	2339	55	14381	20
RAR-2	5/15/01	12.5	479	209	30008	7

**Table 3 (continued): Total Hg, Total PCDD/F and 2,3,7,8-TCDD data  
(May 2001, October 2001 and November 2001 Surveys)**

Station IDs	Date Sampled	Total Hg ng/L	Hg Suspended	Total PCDD/F pg/L	Total PCDD/F pg/g	Total 2,3,7,8 TCDD Pg/g
			Sediment ng/g			
ELIZ1	05/22/01	59.8	1633	963	41687	10
RHWY1	05/22/01	115	3041	982	9727	7
AK1-D	05/22/01	45.3	4384	57	6724	15
PA-S	05/22/01	23.6	1888	245	25071	22
PA-D	05/22/01	30.4	3040	136	9142	10
HAC1	10/17/01	58.4	5733	155	7171	134
HAC2	10/17/01	114	4691	296	15375	139
HAC3	10/17/01	125	3888	373	13529	72
PAS1	10/19/01	88.6	2414	472	7014	169
PAS2a	10/19/01	105	1048	368	11566	444
PAS3	10/19/01	83.9	1462	430	11187	390
NB001-S	10/19/01	21.8	3254	137	7552	116
NB001-D	10/19/01	17.7	2185	106	8167	96
NB003	10/19/01	19.6	996	41	4391	26
KVK001	10/17/01	13.7	1412	50	3385	15
RAR1-S	10/03/01	9.21	2339	27	9548	13
RAR2	10/03/01	10.2	479	312	25632	
ELIZ1	11/06/01	16.2	2893	29	13050	62
RWY1	11/06/01	37.7	6713	53	10206	15
AK1-D	11/06/01	17.9	4163	61	10392	39
PA-S	11/06/01	11.5	1993	51	11914	
PA-D	11/06/01	11.6	2522	47	16172	

**Table 3 (continued): Total Hg, Total PCDD/F and 2,3,7,8-TCDD data  
(March 2002, May 2002 Surveys)**

Station IDs	Date Sampled	Total Hg ng/L	Hg Suspended Sediment ng/g	Total PCDD/F pg/L	Total PCDD/F pg/g	Total 2,3,7,8 TCDD Pg/g
HAC1	03/14/02	25.4	3059	42	11497	174
HAC2	03/14/02	35.5	2892	56	12659	92
HAC3	03/14/02	387	11083	138	4398	21
PAS-1	03/12/02	Not Collected	Not Collected	117	12415	353
PAS-2a	03/12/02	Not Collected	Not Collected	101	4079	161
PAS-3	03/12/02	Not Collected	Not Collected	162	9125	154
NB001-S	03/13/02	Not Collected	Not Collected	41	9588	101
NB001-D	03/13/02	Not Collected	Not Collected	43	7169	71
NB003	03/13/02	Not Collected	Not Collected	21	4102	25
KVK001	03/14/02	11.4	1175	40	4862	25
RAR1-S	03/27/02	11.3	1679	130	8631	9
RAR-2	03/27/02	7.21	530	248	40818	7
ELIZ1	05/14/02	Blank Censored	Blank Censored	146	23753	45
RWY1	05/14/02	163	3021	1428	24082	22
AK1-S	05/14/02	28.7	5263	94	11870	60

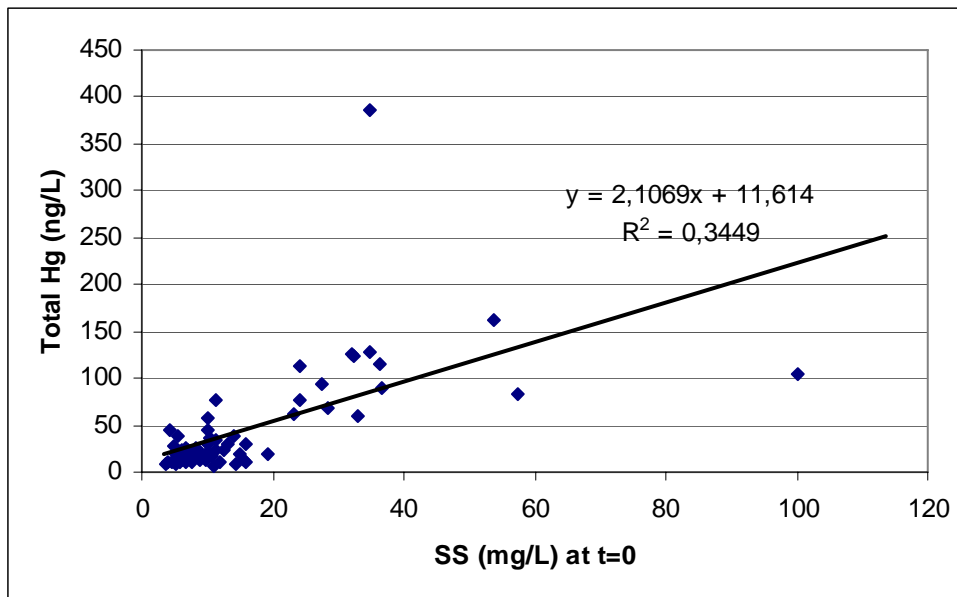
#### 4.1 Correlations between SS, carbon, and toxics (total Hg, total PCDD/F, and 2,3,7,8-TCDD)

**Hypothesis:** The concentrations of toxic contaminants (specifically Hg, PCDD/F, and 2,3,7,8-TCDD) are correlated with SS, POC, and DOC levels.

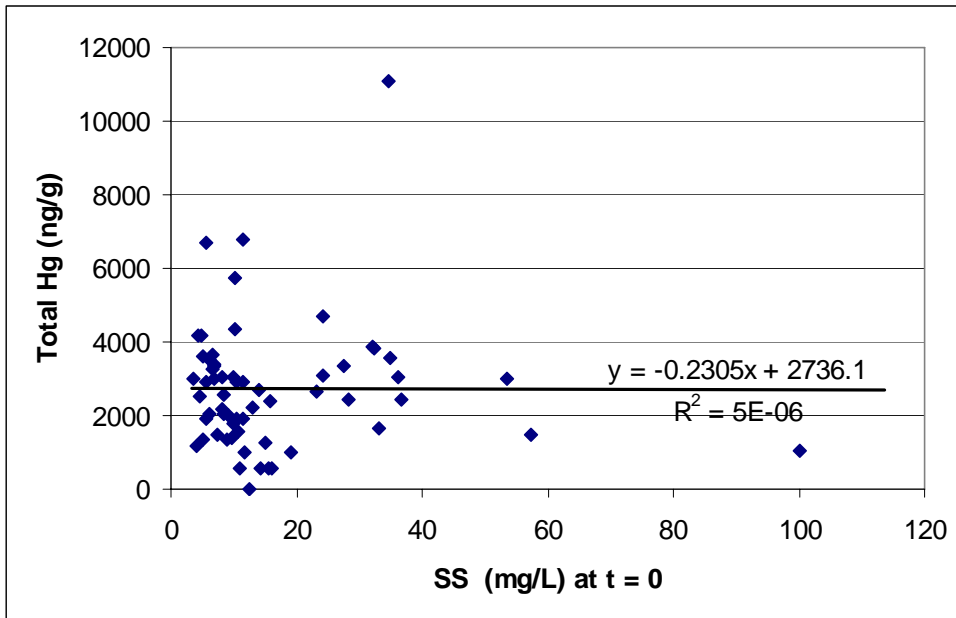
Figure 3 – Figure 5 show linear regression analyses between physicochemical parameters (SS, POC) and total Hg in ng/L and ng/g. The correlation between total Hg in ng/L with SS at t=0 ( $R^2=0.35$ ) are slightly stronger than those with carbon at t=1 ( $R^2=0.16$ ; data not shown). Total Hg concentration in ng/g does not correlate with SS or carbon (see Figures 4 and 5).

Figure 6 – Figure 9 show linear regression analyses between physicochemical parameters (SS, POC) and total PCDD/F in pg/L and pg/g. The correlation between total PCDD/F concentrations in pg/L with geometric mean SS are stronger ( $R^2=0.45$ ) than those with carbon ( $R^2=0.13$ ). Total PCDD/F concentrations in pg/g do not correlate with SS or carbon.

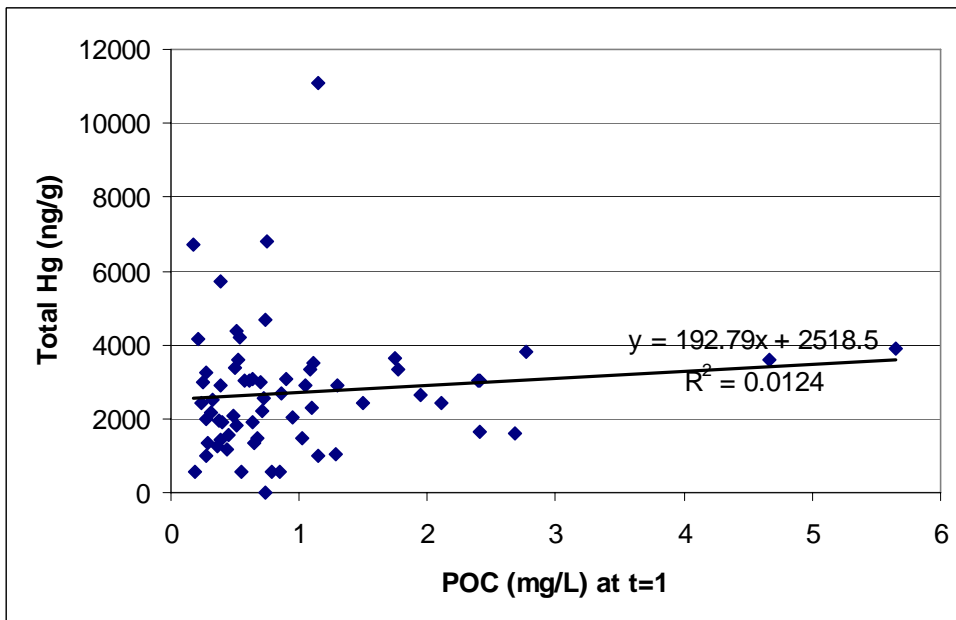
Figure 10 and Figure 11 show linear regression analyses between physicochemical parameters (SS, POC) and 2,3,7,8-TCDD in pg/g. The 2,3,7,8-TCDD concentrations in pg/g do not correlate with SS or carbon.



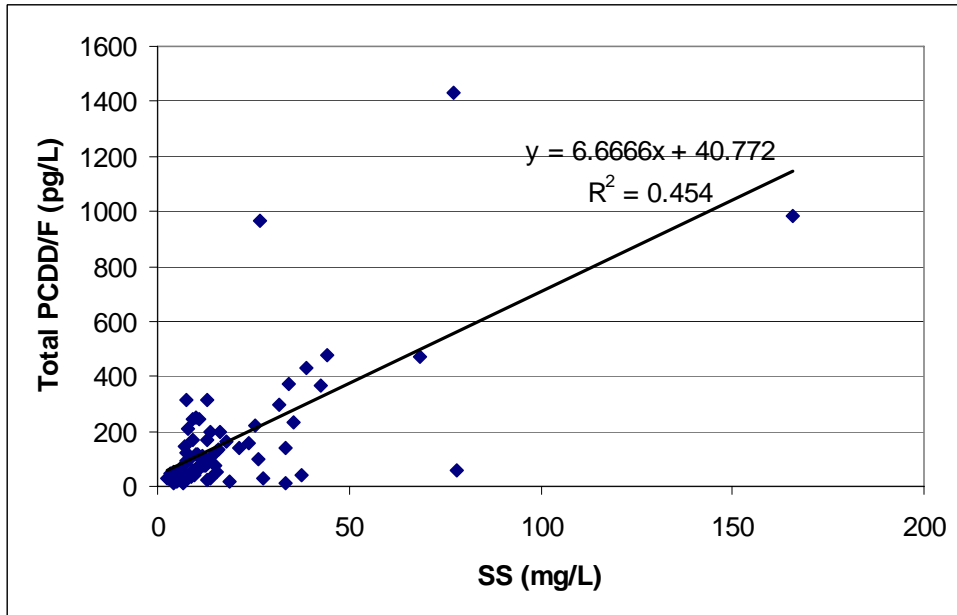
**Figure 3:** Linear Regression Analysis between SS (at t = 0) and Total Hg (ng/L)



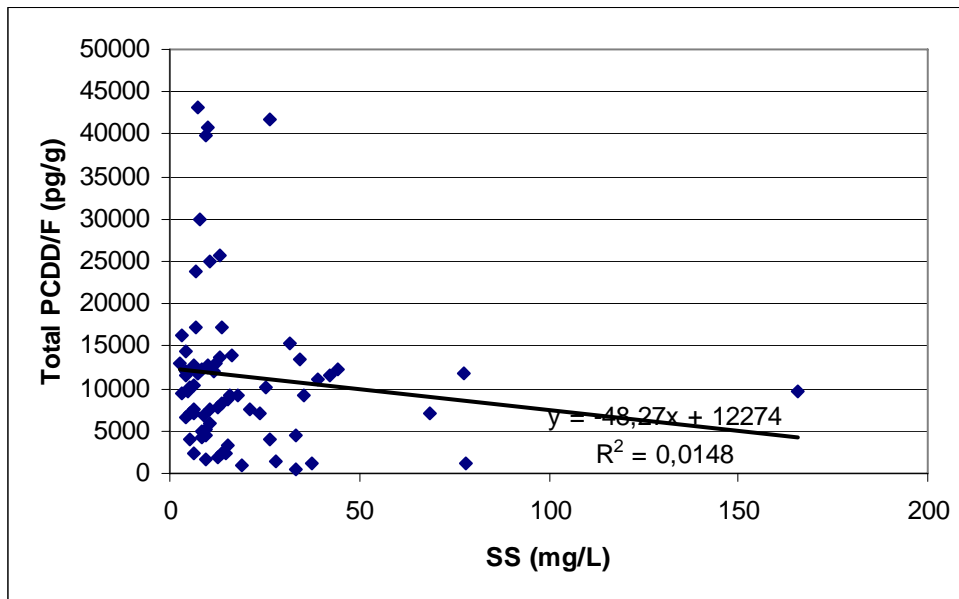
**Figure 4:** Linear Regression Analysis between SS (at t = 0) and Total Hg (ng/g)



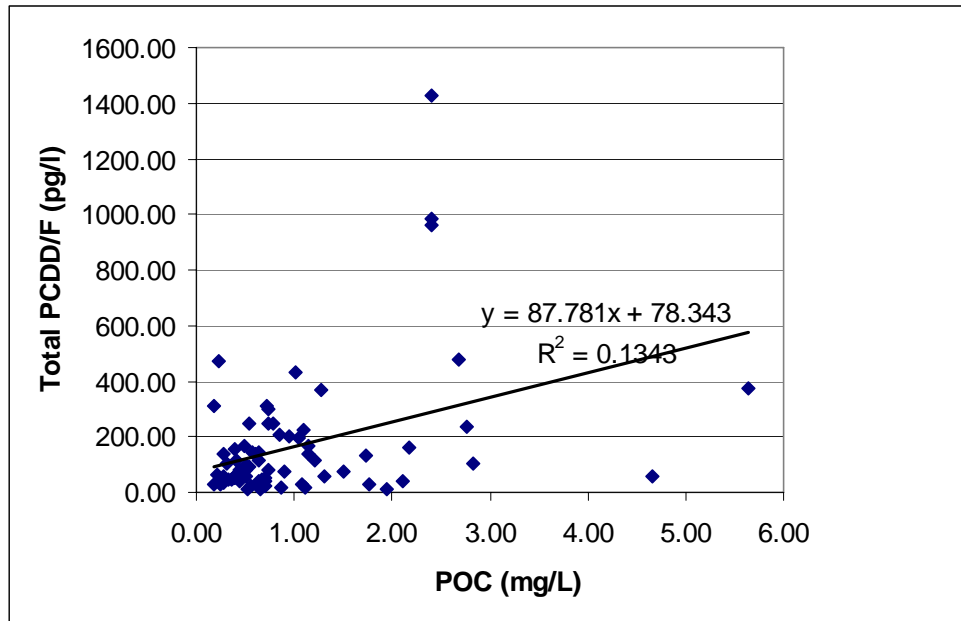
**Figure 5:** Linear Regression Analysis between POC (at t = 1) and Total Hg (ng/g)



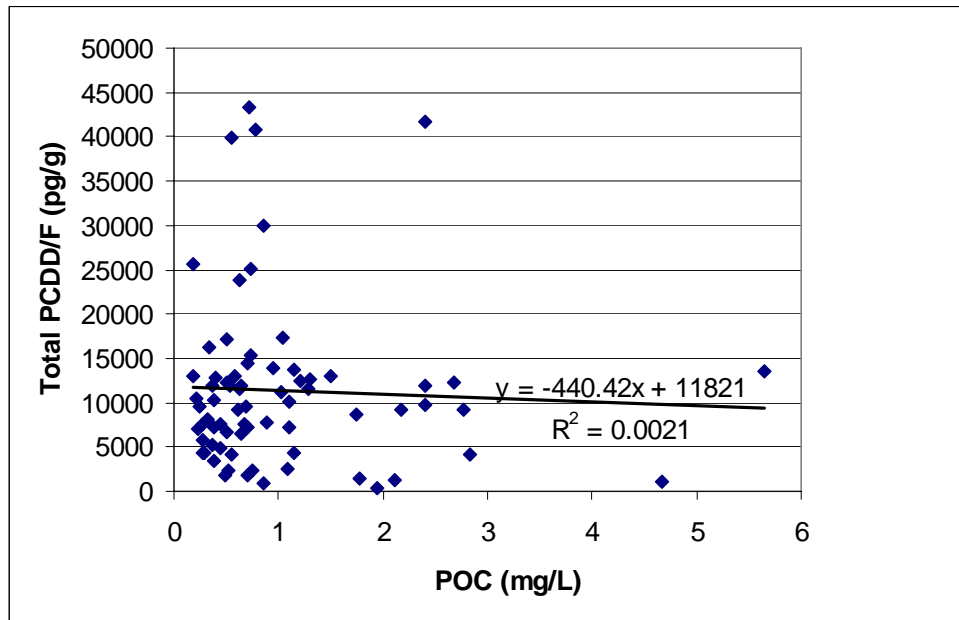
**Figure 6:** Linear Regression Analysis between SS (geometric mean) and Total PCDD/F (pg/L)



**Figure 7:** Linear Regression Analysis between SS (geometric mean) and Total PCDD/F (pg/g)

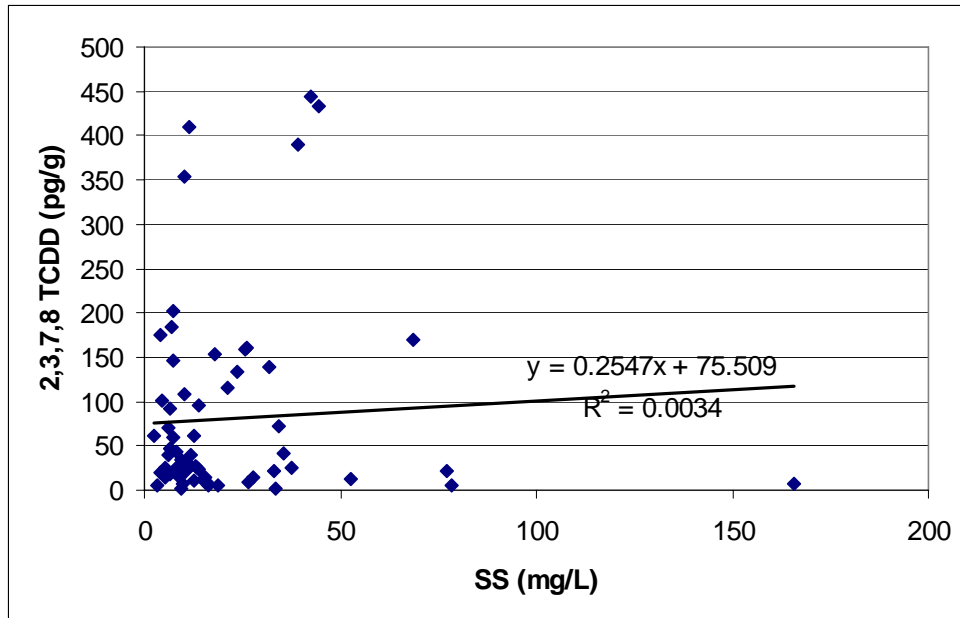


**Figure 8:** Linear Regression Analysis between POC (geometric mean) and Total PCDD/F (pg/L)

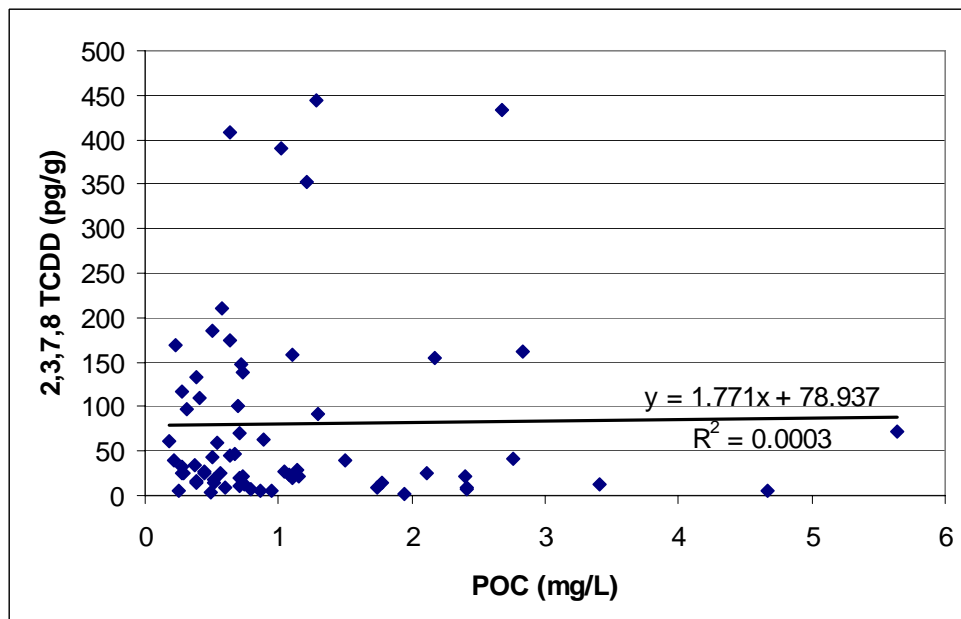


**Figure 9:** Linear Regression Analysis between POC (geometric mean) and Total PCDD/F (pg/g)





**Figure 10:** Linear Regression Analysis between SS (geometric mean) and 2,3,7,8 TCDD (pg/g)



**Figure 11:** Linear Regression Analysis between POC (geometric mean) and 2,3,7,8 TCDD (pg/g)

## 4.2 Dependence of SS and carbon data on the phase of the tide

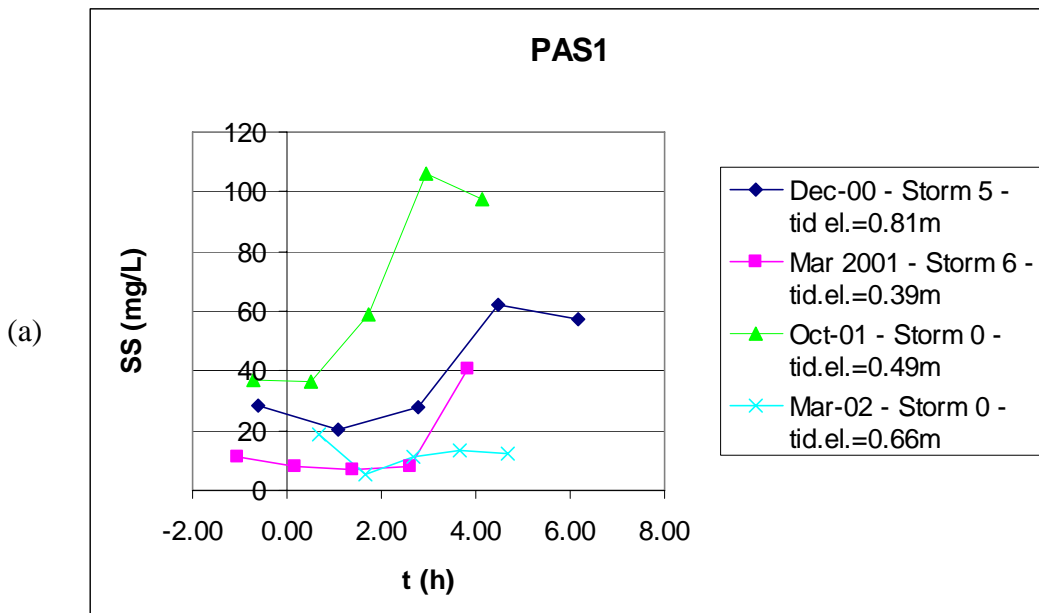
**Hypothesis:** The observed levels of SS and POC will vary in a consistent manner over the course of the tidal cycle.

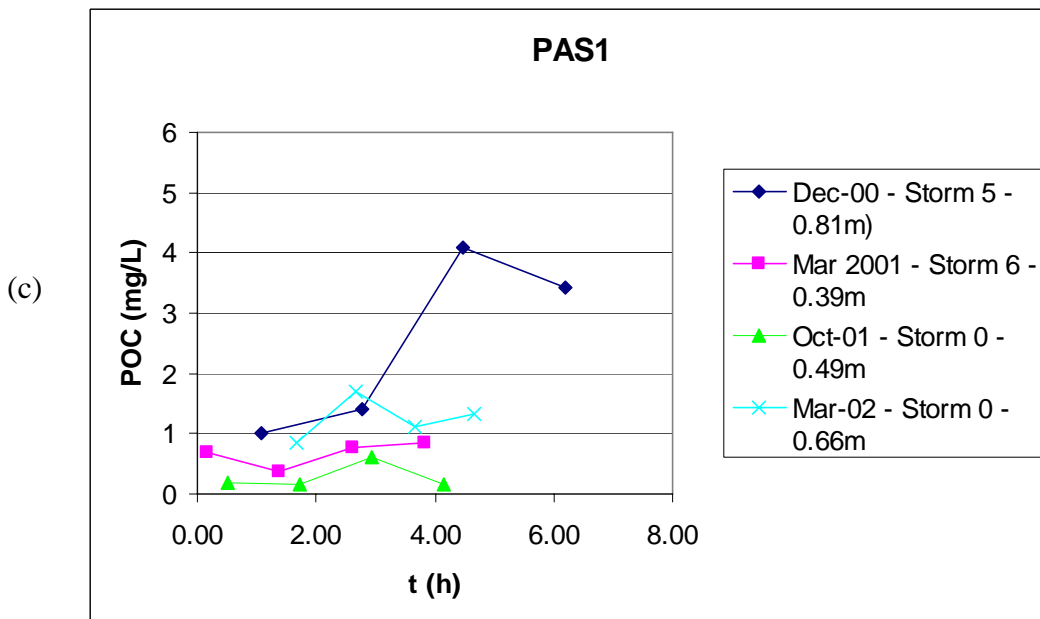
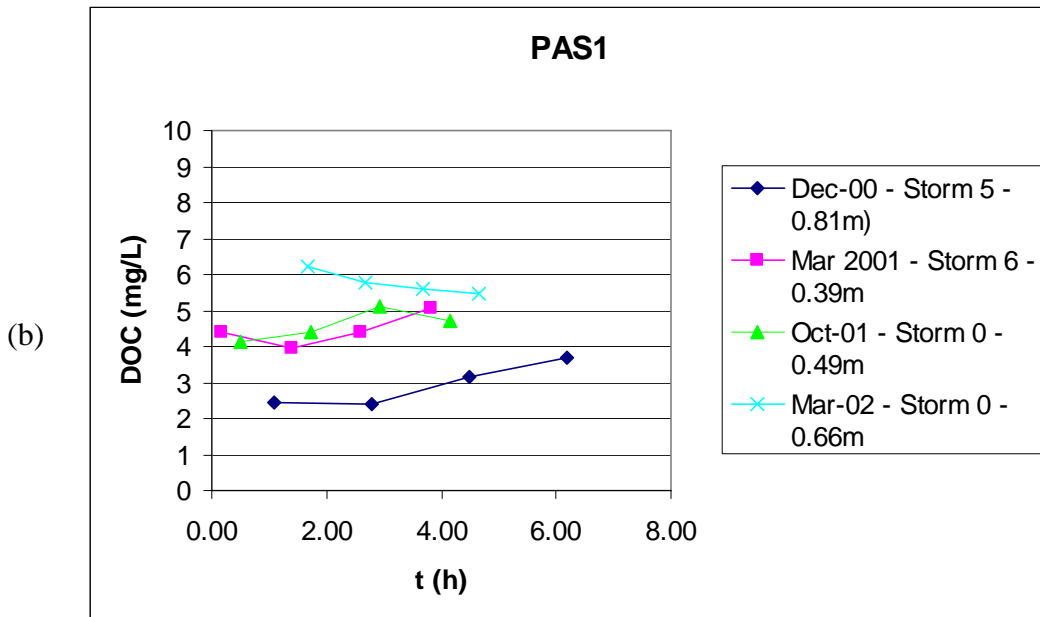
**Hypothesis:** The observed levels of SS and POC will vary in a consistent manner in response to storm/river flow conditions.

### 4.2.1 Passaic River

Figure 12 – Figure 14 present the SS, DOC and POC data during the four sampling events, where time = 0 is the time of the high tide. The Storm category and the maximum tidal elevation at the Newark Bay Station are indicated.

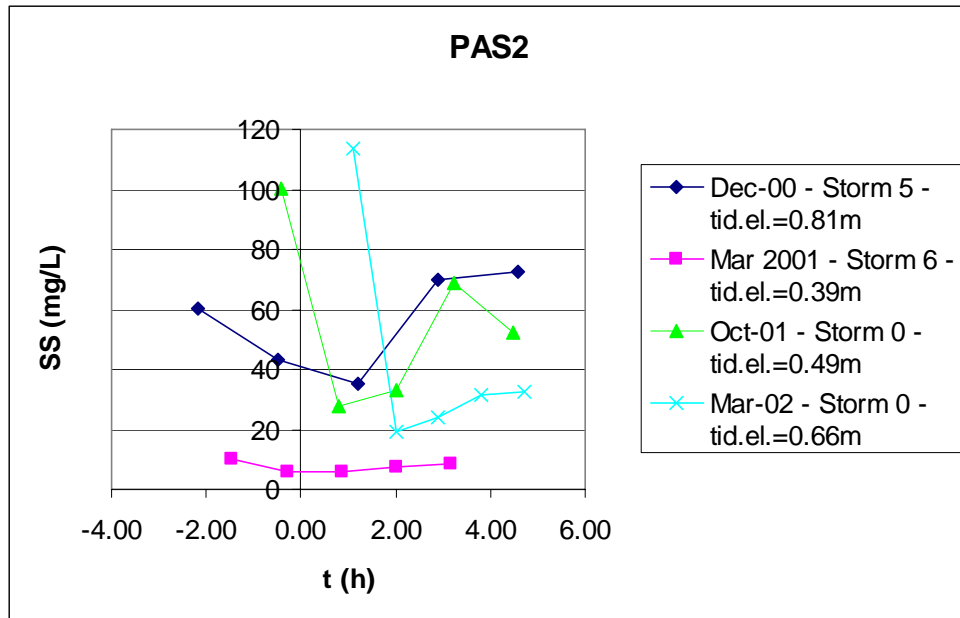
Over the course of each sampling event, SS, POC, and DOC varied little at the upstream sampling station PAS3. All three parameters are elevated during the March 2002 dry weather event, with the highest SS levels observed in the October 2001 dry weather event. In contrast, the highest POC values are measured at stations PAS1 and PAS2 during the Dec 2000 sampling event; SS levels were also elevated. This was a storm event with a high maximum tidal elevation (0.81m). Thus, the elevated POC and SS levels are probably due to the resuspension of Newark Bay and Passaic River sediments due to strong tidal currents. In comparison, during the March 2001 storm event, the POC and SS concentrations were not elevated, and the maximum tidal elevation was the lowest of all four sampling events. There was little variability of DOC over the sampling period at all three stations. The lowest DOC levels (less than 4 mg/l) were observed at all three stations during the Dec 2000 event. DOC levels were similar (~ 4 – 7mg/l) during the other three sampling events at all three stations.



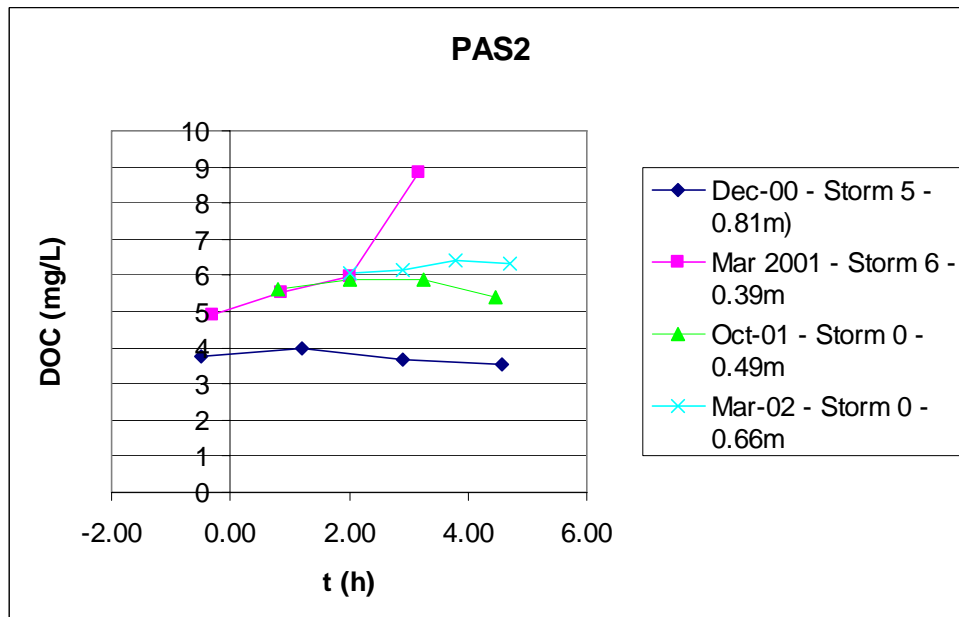


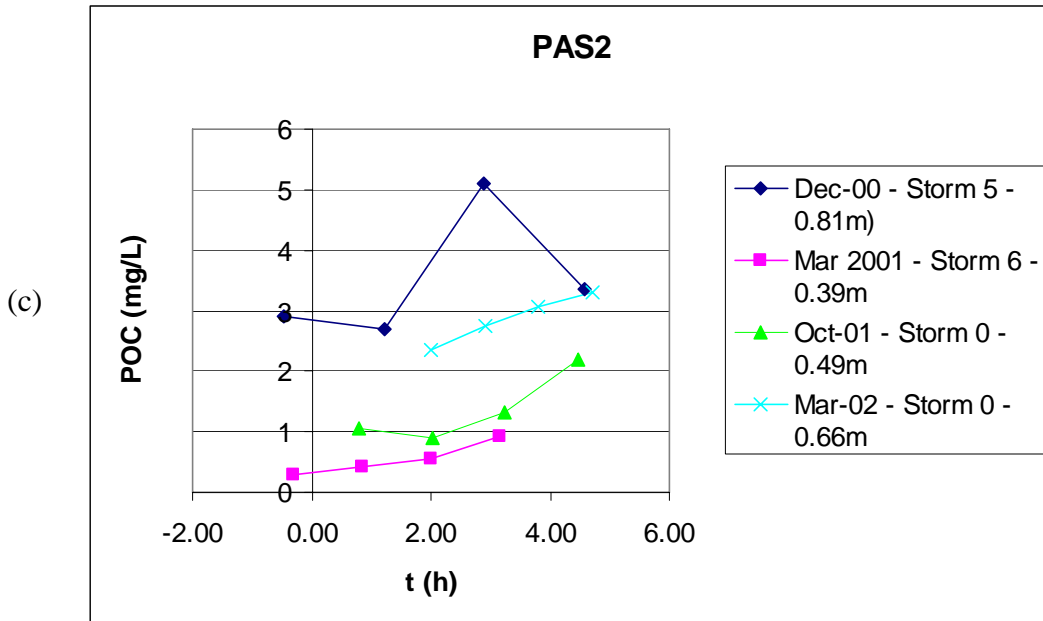
**Figure 12:** (a) SS, (b) DOC and (c) POC measurements at the PAS1 sampling station

(a)

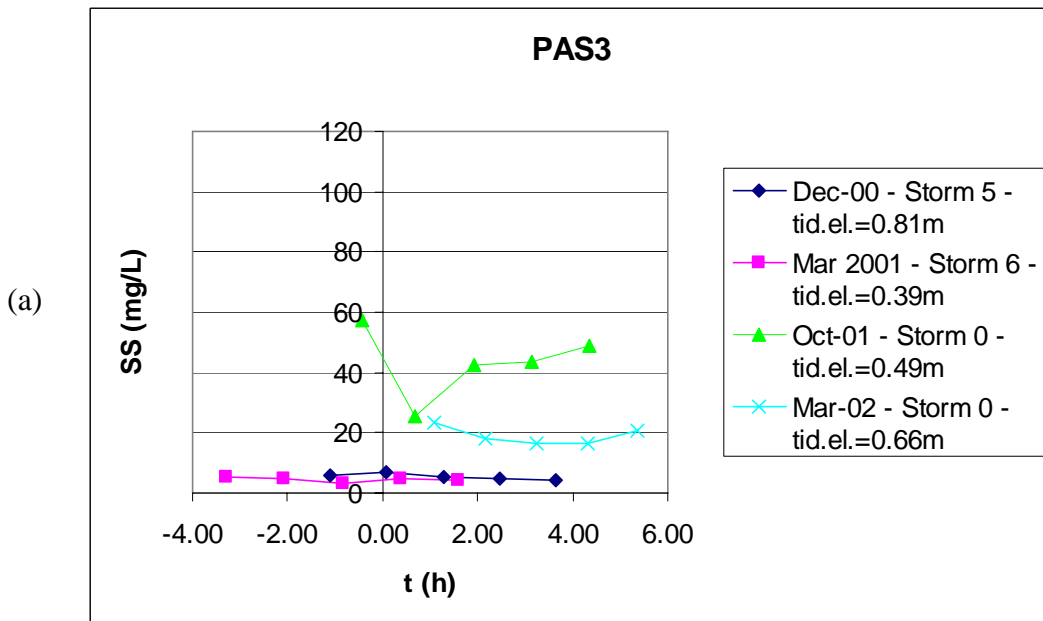


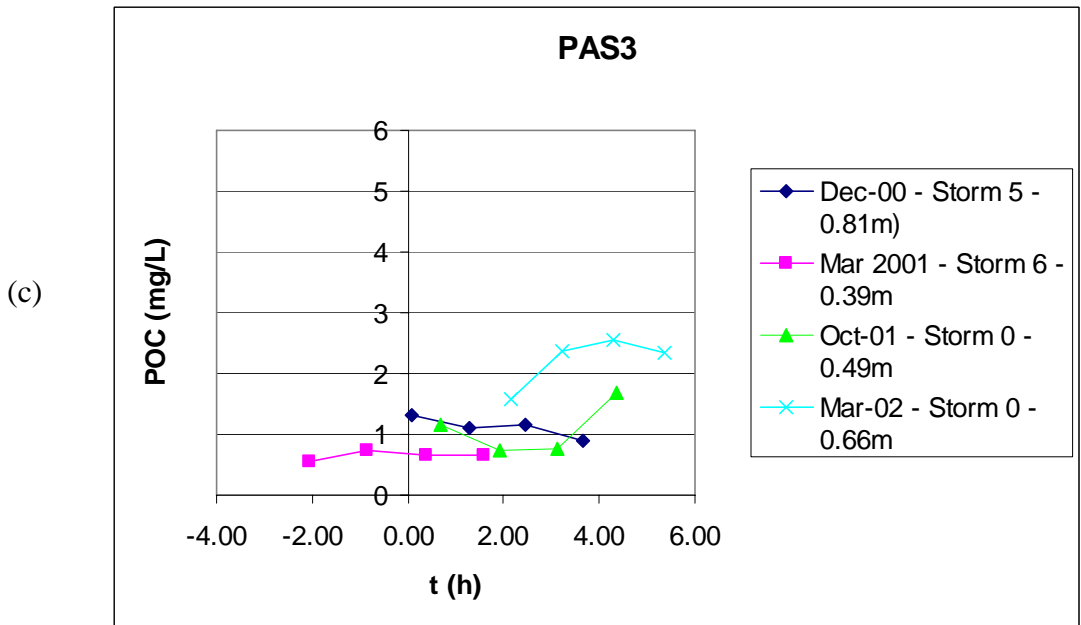
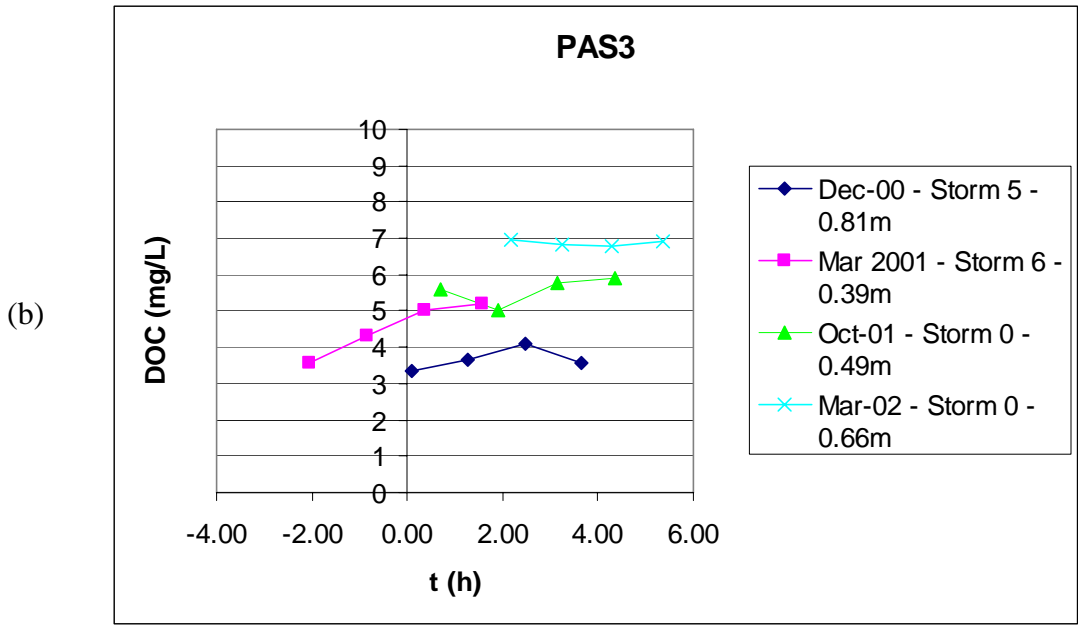
(b)





**Figure 13:** (a) SS, (b) DOC and (c) POC measurements at the PAS2 sampling station



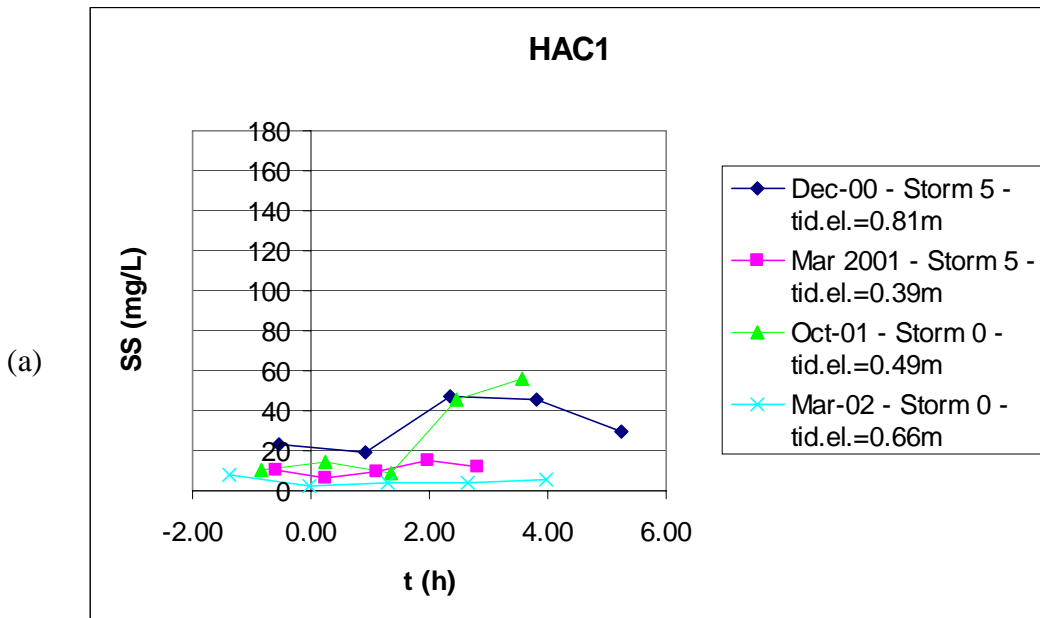


**Figure 14:** (a) SS, (b) DOC and (c) POC measurements at the PAS3 sampling station

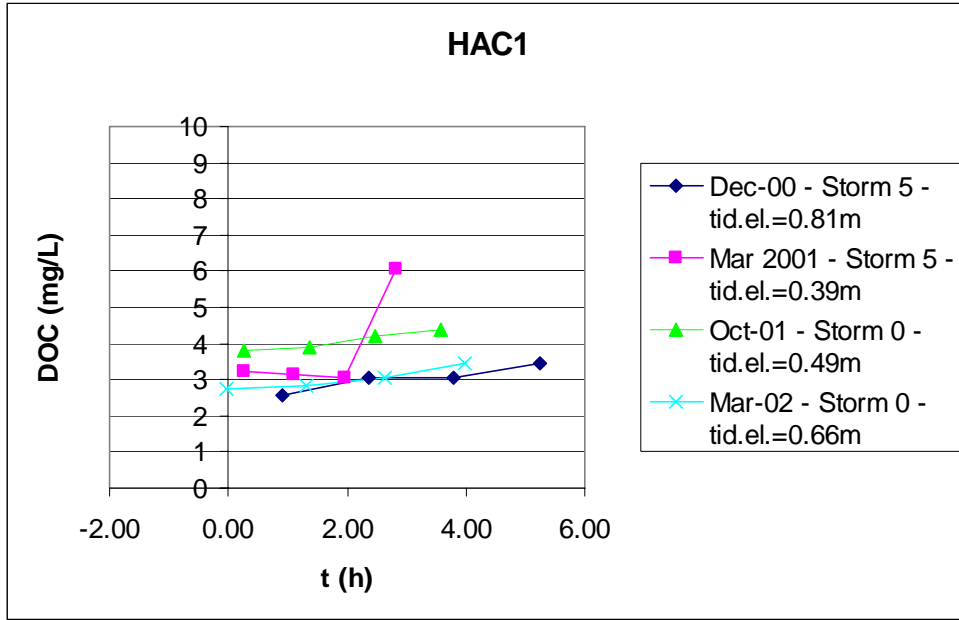
#### 4.2.2 Hackensack River

Figure 15 - Figure 17 present the SS, DOC and POC data during the four sampling events, where time = 0 is the time of the high tide. The Storm category and the maximum tidal elevation at the Newark Bay Station are indicated.

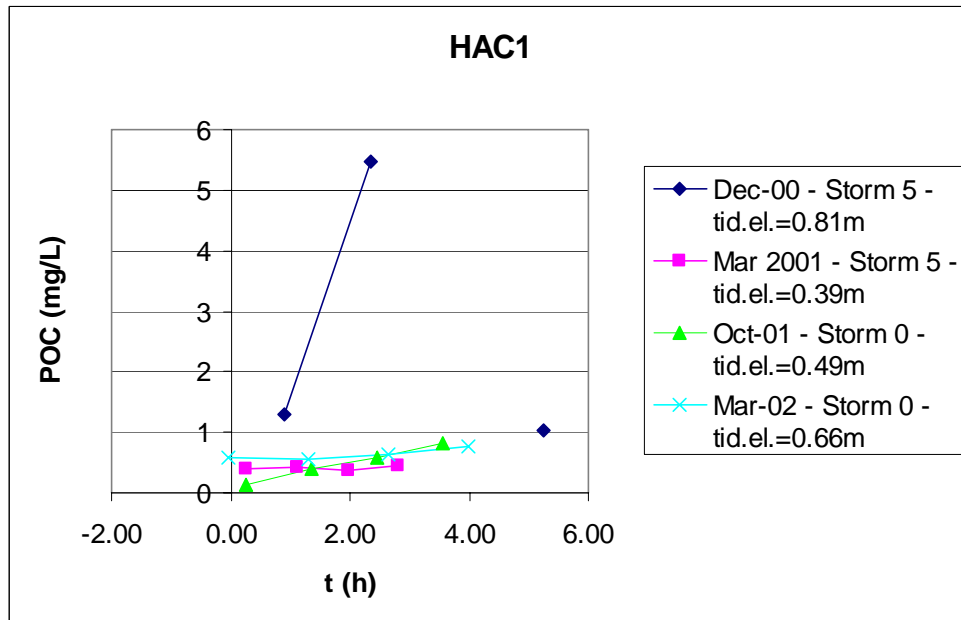
The HAC2 sampling station shows the lowest, and the HAC3 sampling station the highest, variability in SS values. Suspended sediment levels are similar at HAC1 and HAC2 (20-40 mg/L), and higher at HAC3 (40-80 mg/L). The highest and most variable POC values are measured at the HAC3 sampling station, particularly during the October 2001 dry weather event. POC varied little during each sampling event at all three stations. Likewise, there is little DOC variability over the course of the sampling period at all three stations. The DOC levels are lowest at Station HAC1 (less than 4mg/l), and similar at stations HAC2 and HAC3 (6-8 mg/l), except for the March 2002 event where the DOC levels at station HAC3 are higher (~ 9.5mg/l).



(b)



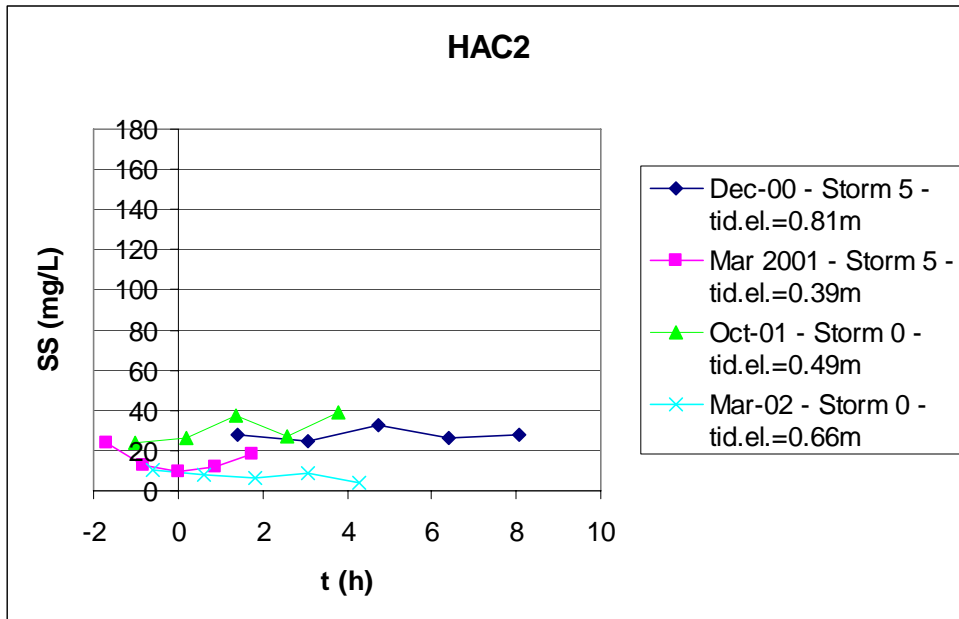
(c)



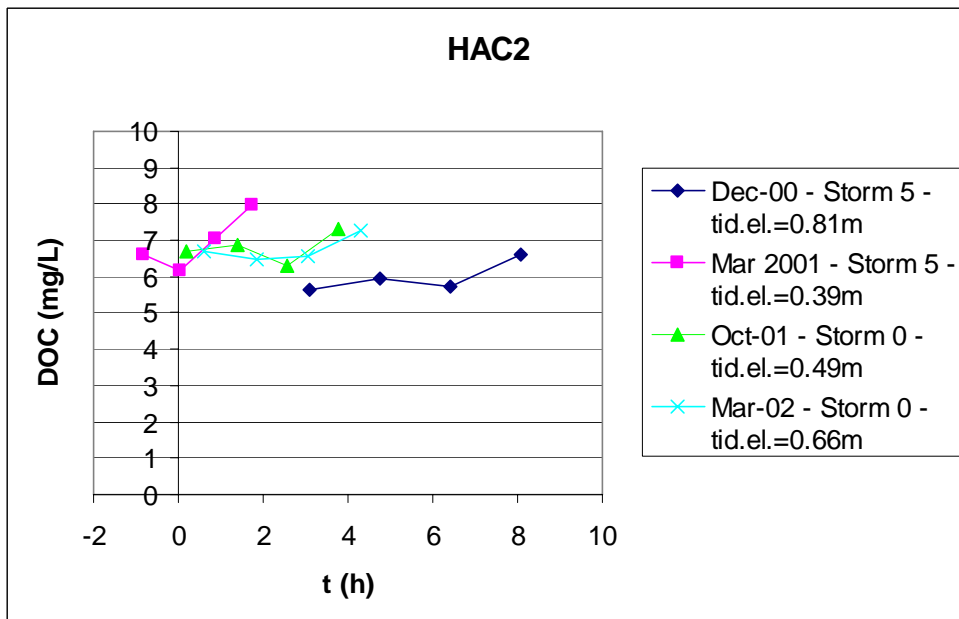
**Figure 15:** (a) SS, (b) DOC and (c) POC measurements at the HAC1 sampling station



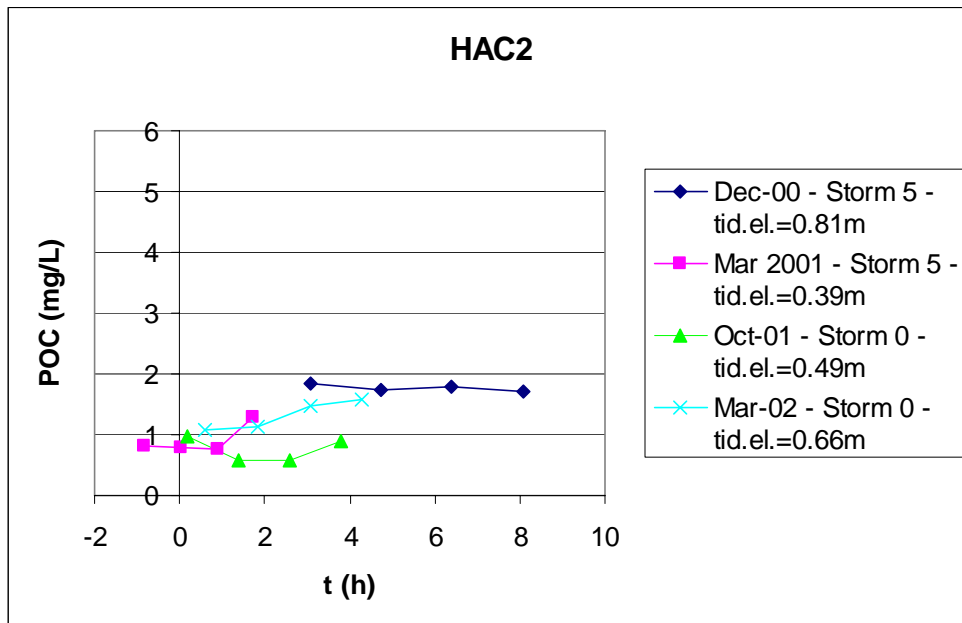
(a)



(b)

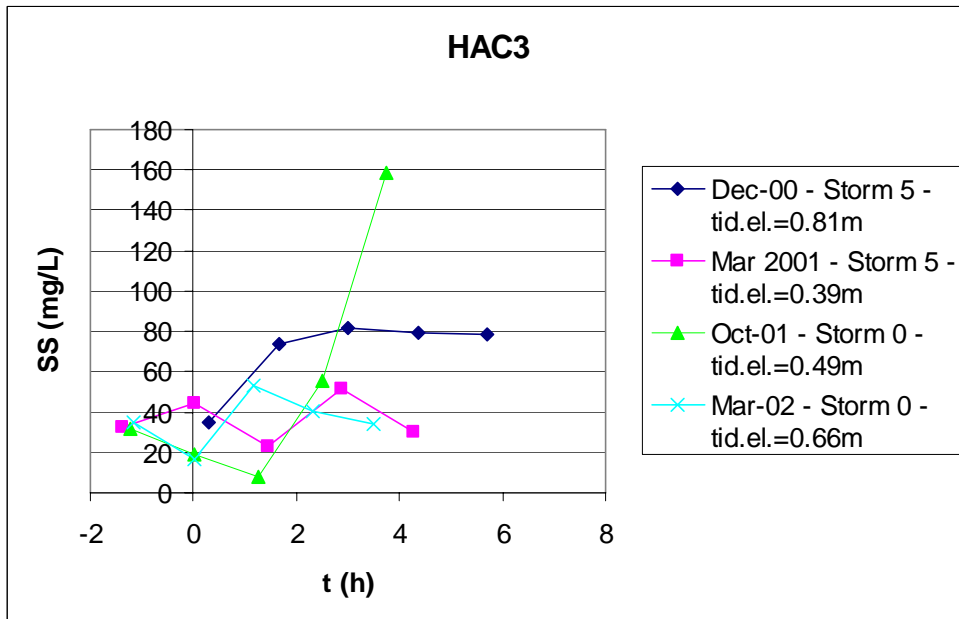


(c)

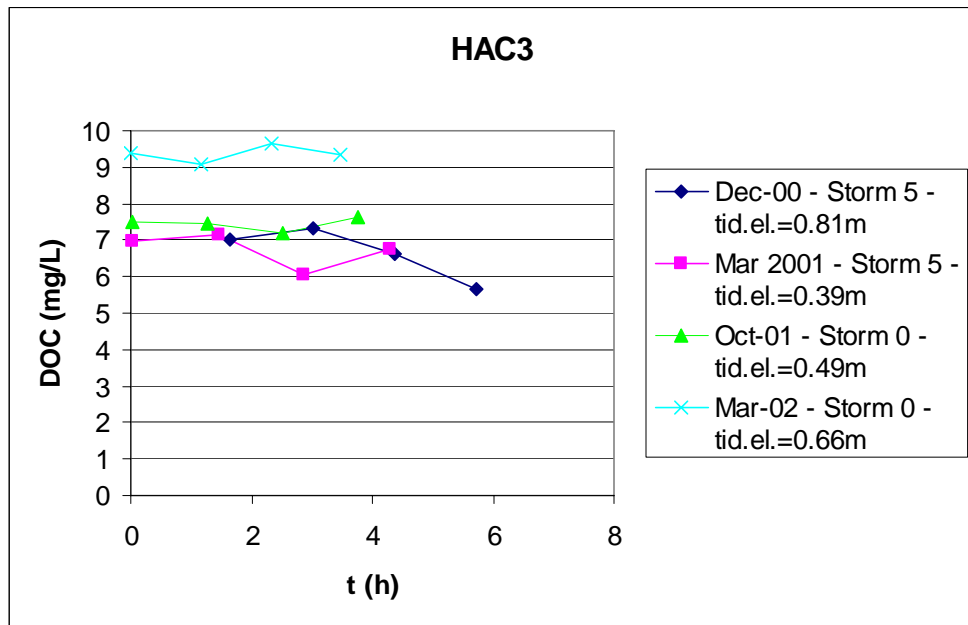


**Figure 16:** (a) SS, (b) DOC and (c) POC measurements at the HAC2 sampling station

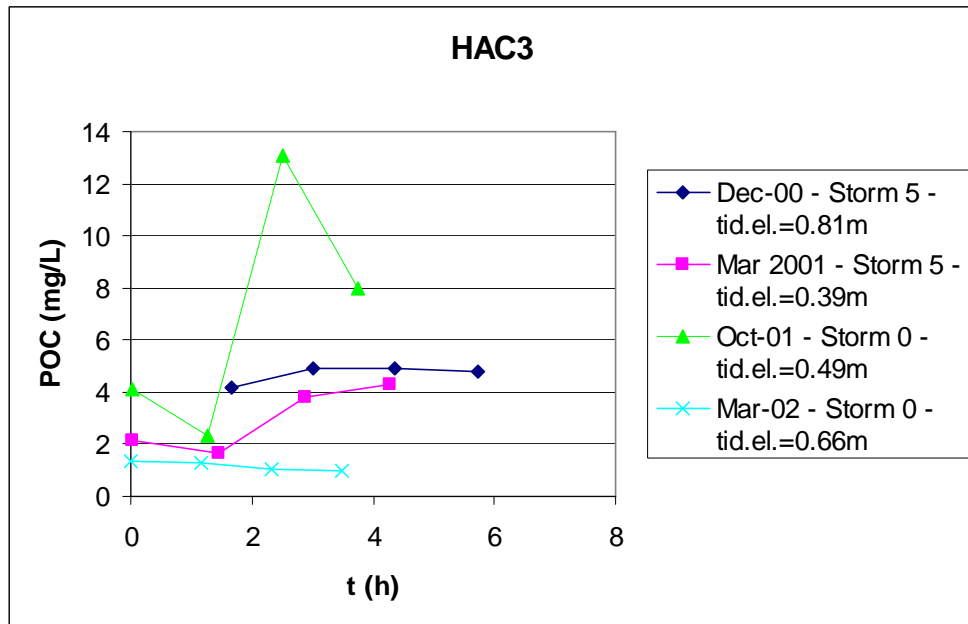
(a)



(b)



(c)

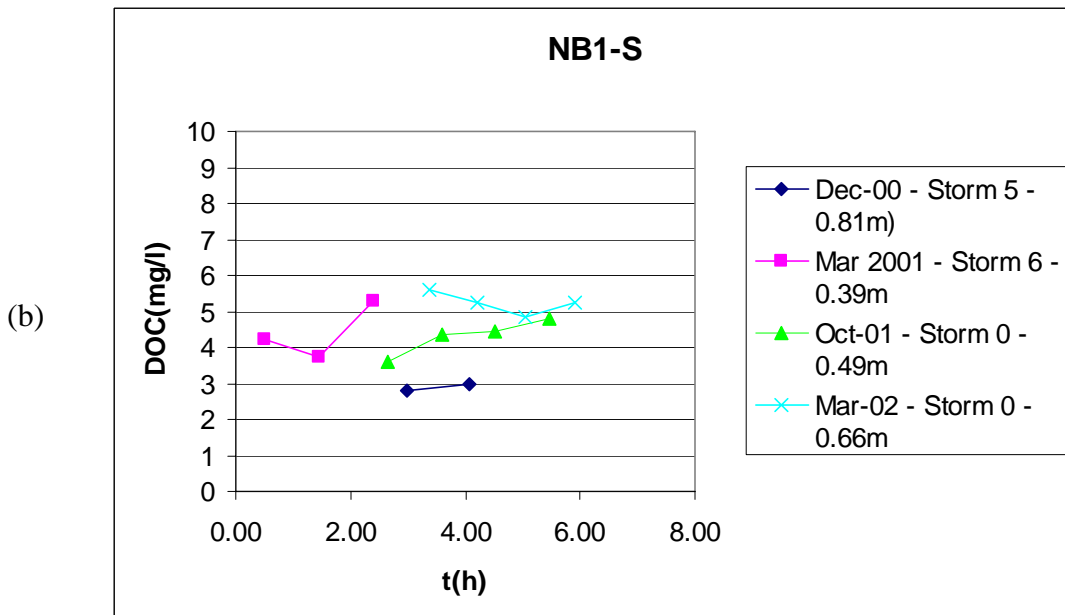
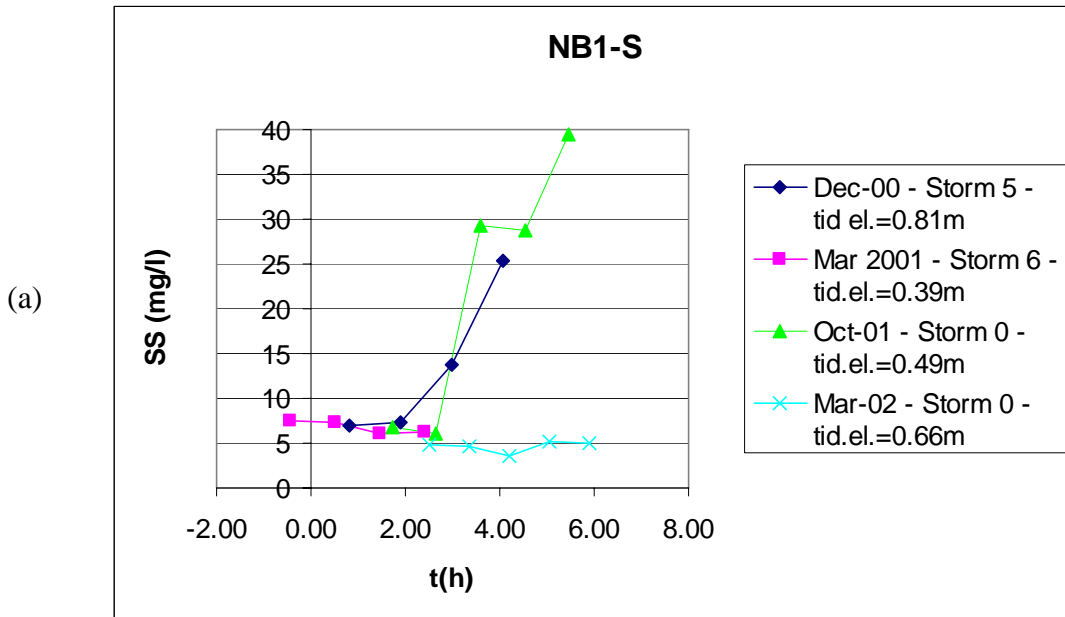


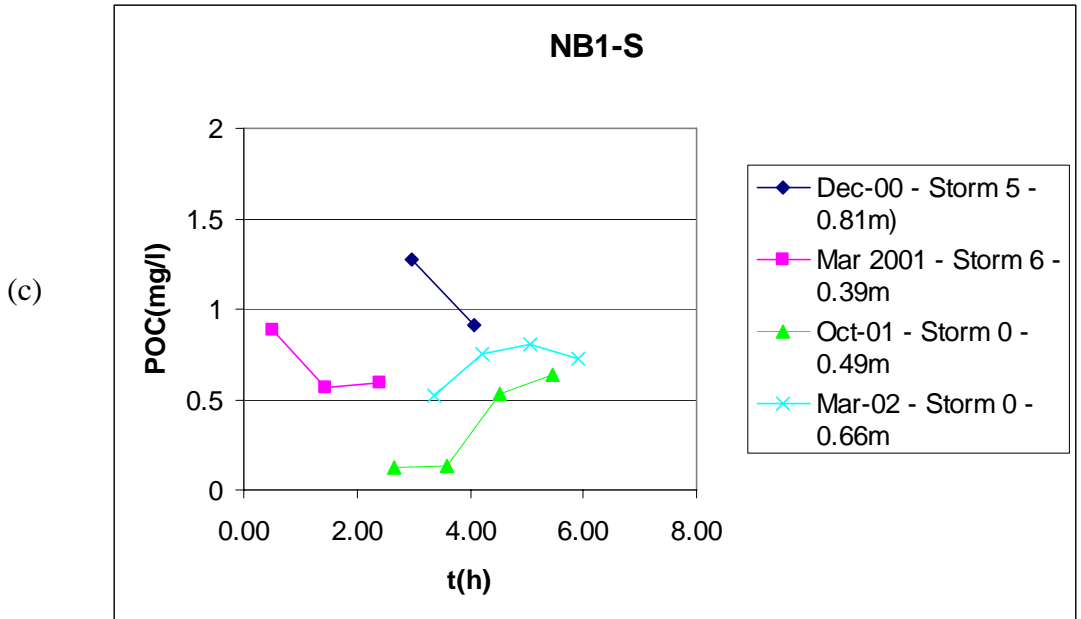
**Figure 17:** (a) SS, (b) DOC and (c) POC measurements at the HAC3 sampling station

### 4.2.3 Newark Bay

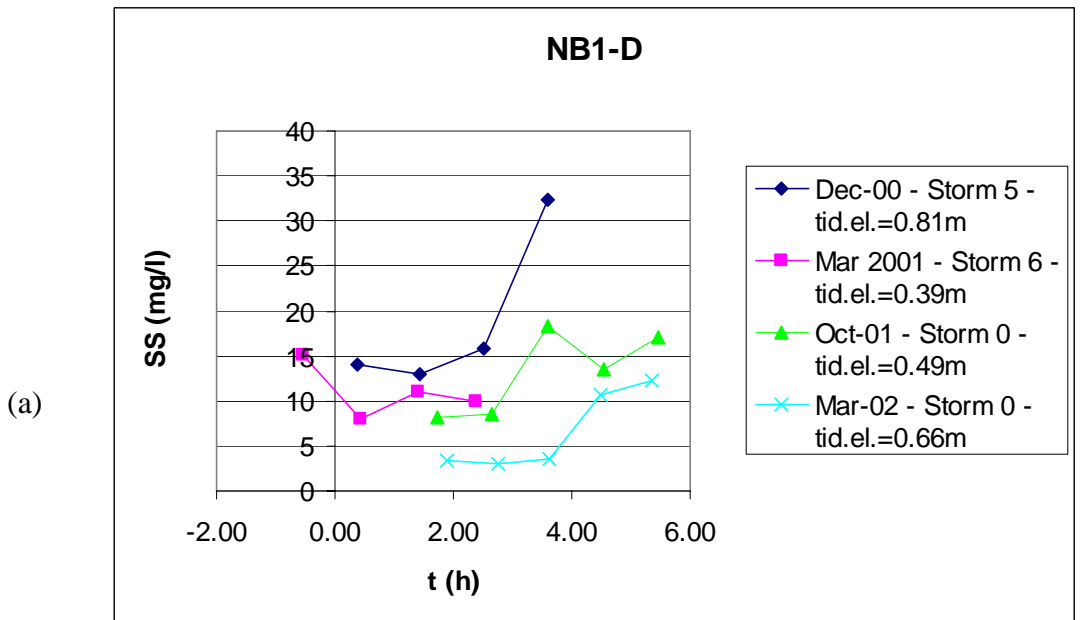
Figure 18 – Figure 20 present the SS, DOC and POC data during the four sampling events, where time = 0 is the time of the high tide. The Storm category and the maximum tidal elevation at the Newark Bay Station are indicated.

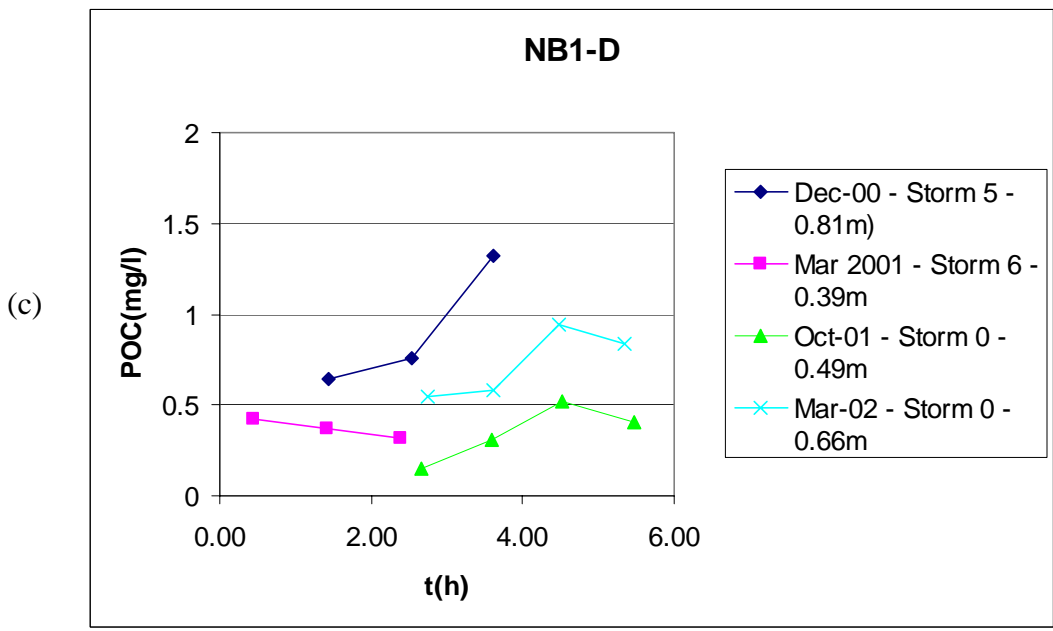
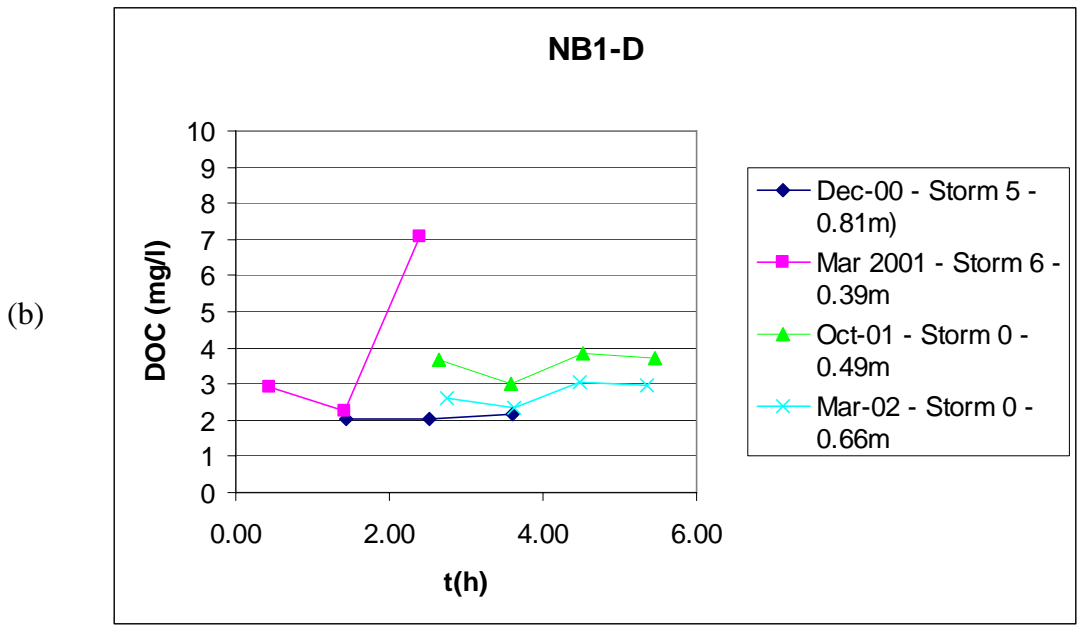
During the course of each sampling event, DOC and POC concentrations tended to vary very little. Variability in SS was greater, with Station NB1 showing a higher SS tidal variability compared to the NB3 Station.





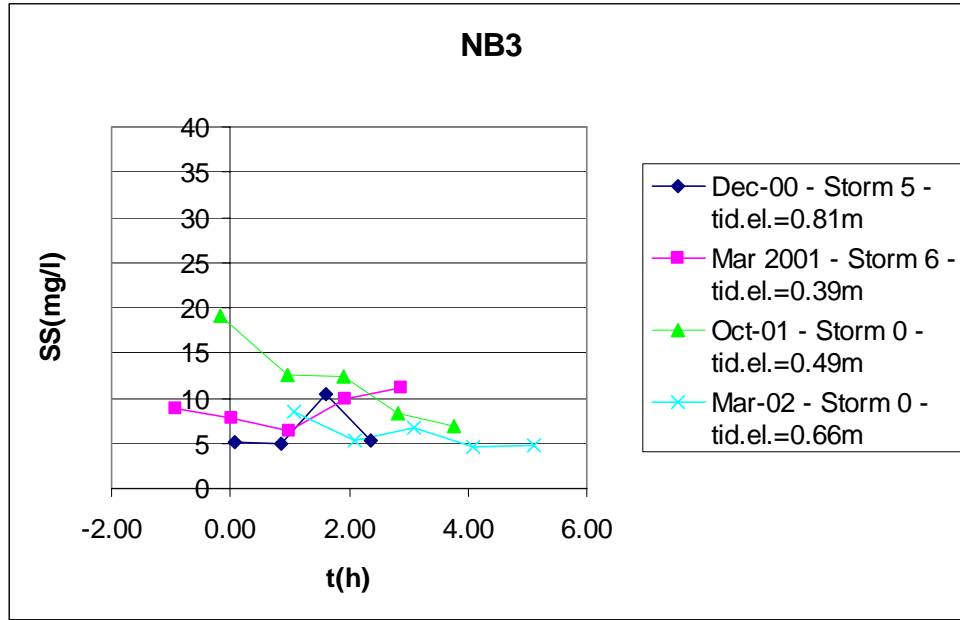
**Figure 18:** (a) SS, (b) DOC and (c) POC measurements at the NB1-S sampling station



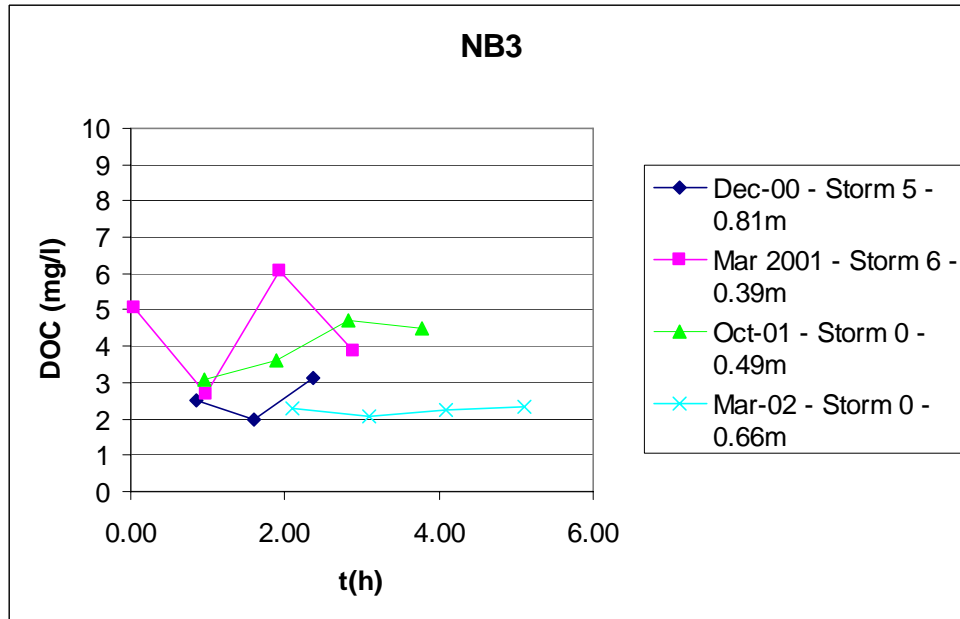


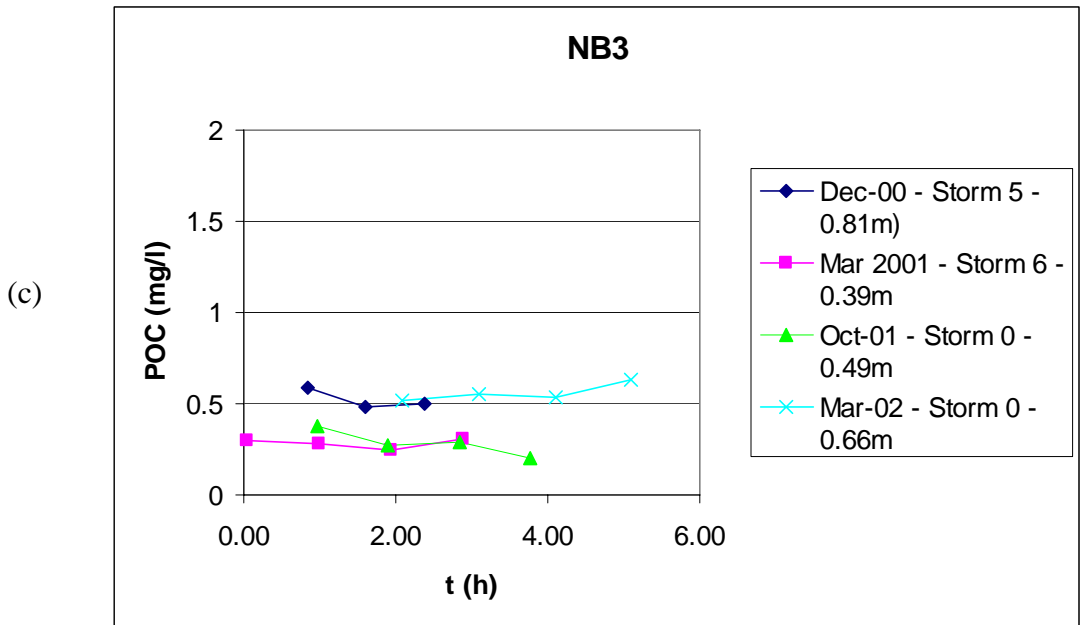
**Figure 19:** (a) SS, (b) DOC and (c) POC measurements at the NB1-D sampling station

(a)



(b)





**Figure 20:** (a) SS, (b) DOC and (c) POC measurements at the NB3 sampling station

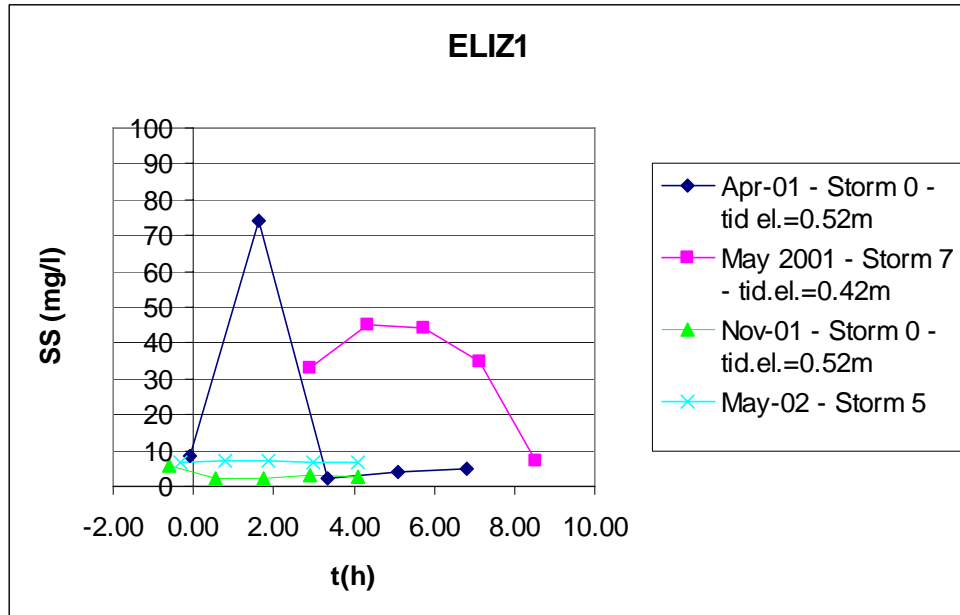
#### 4.2.4 Elizabeth River

Figure 21 presents the SS, DOC and POC data during the four sampling events, where time = 0 is the time of the high tide. Where available, the maximum tidal elevation is also indicated.

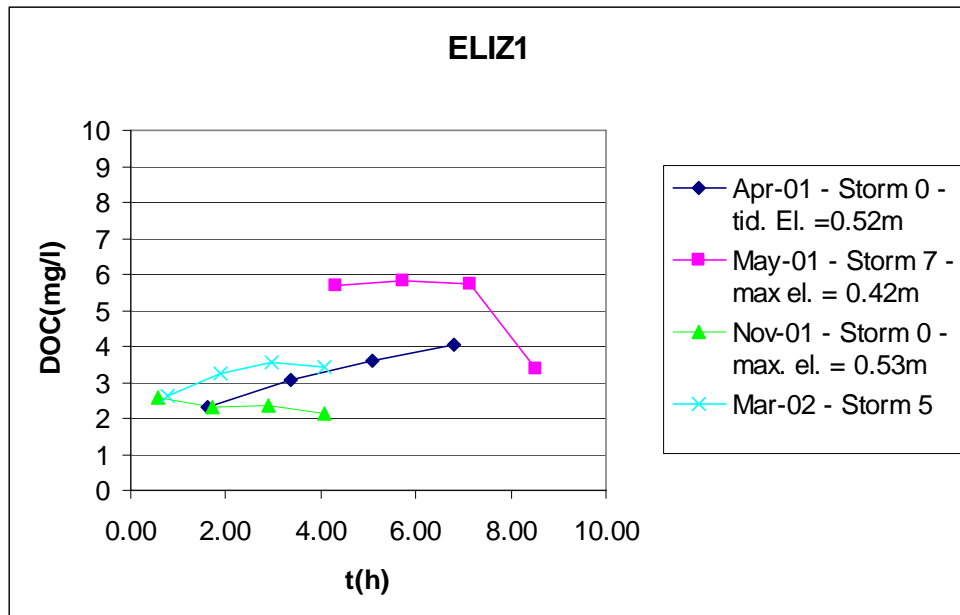
Assuming that the high SS value during the April 2001 sampling event is an outlier, high carbon and SS values are measured only during the May 2001 storm event. In the May 2001 sampling event, there is also tidal variability during the course of sampling for all three parameters. In contrast, during the other three sampling events, the SS and carbon measurements do not change significantly with time.

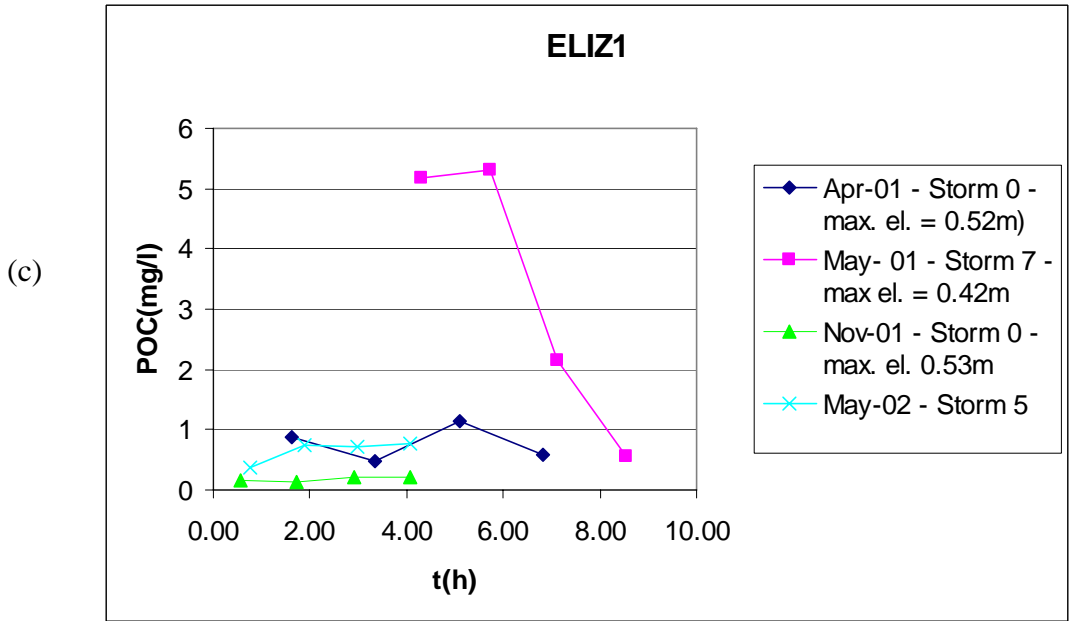


(a)



(b)



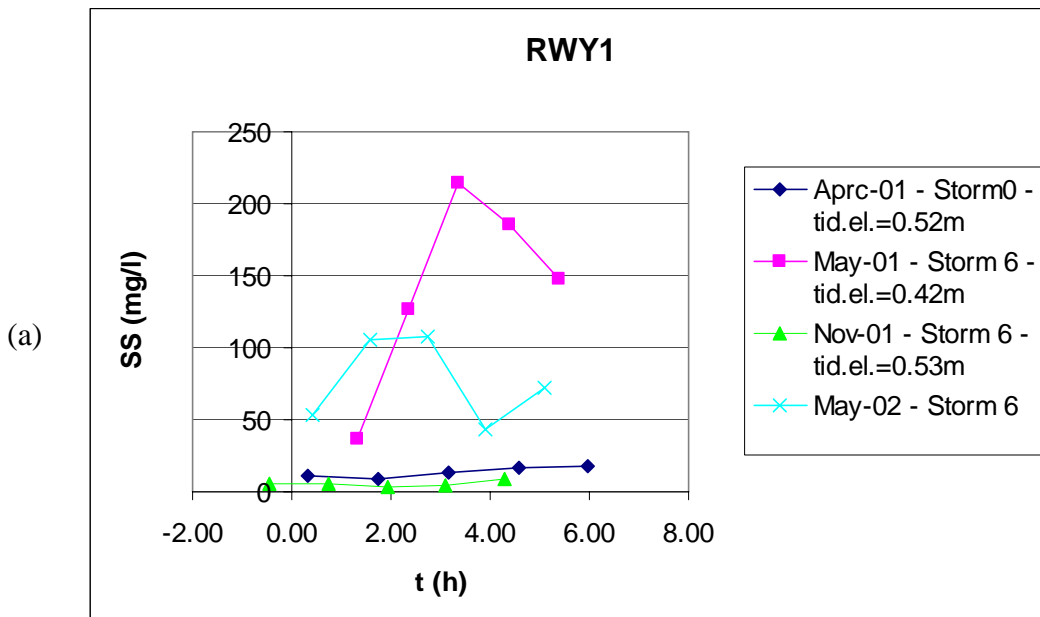


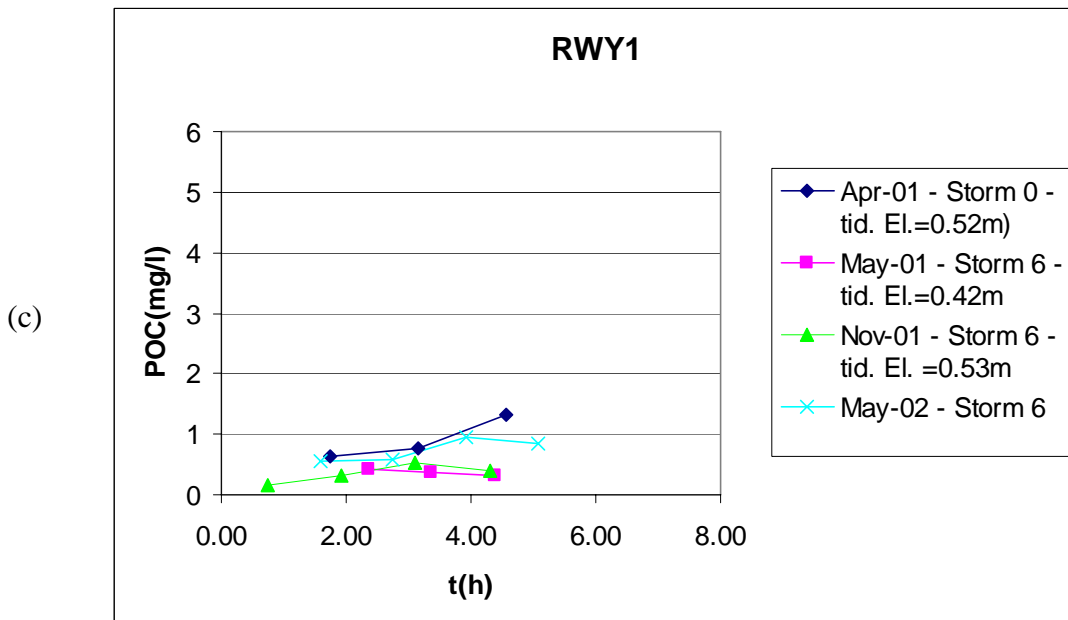
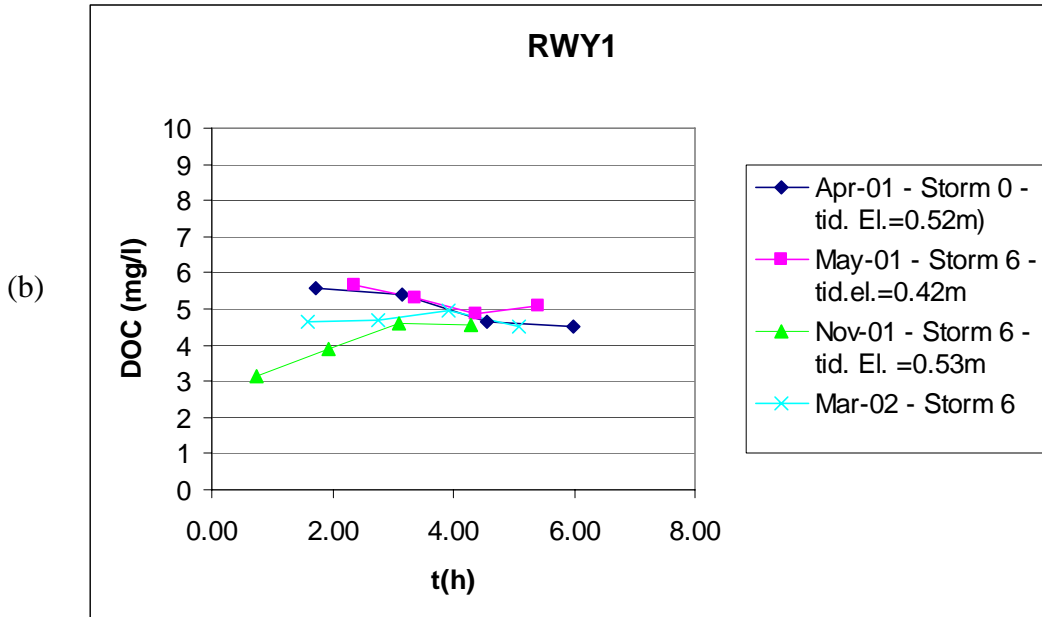
**Figure 21:** (a) SS, (b) DOC and (c) POC measurements at the ELIZ sampling station

#### 4.2.5 Rahway River

Figure 22 presents the SS, DOC and POC data during the four sampling events, where time = 0 is the time of the high tide. Where available, the maximum tidal elevation is also indicated.

There is a very little variability in the carbon measurements among the different events. High SS values and tidal variability during sampling are apparent in the May 2001 and May 2002 storm events, but not during the November 2001 storm event.





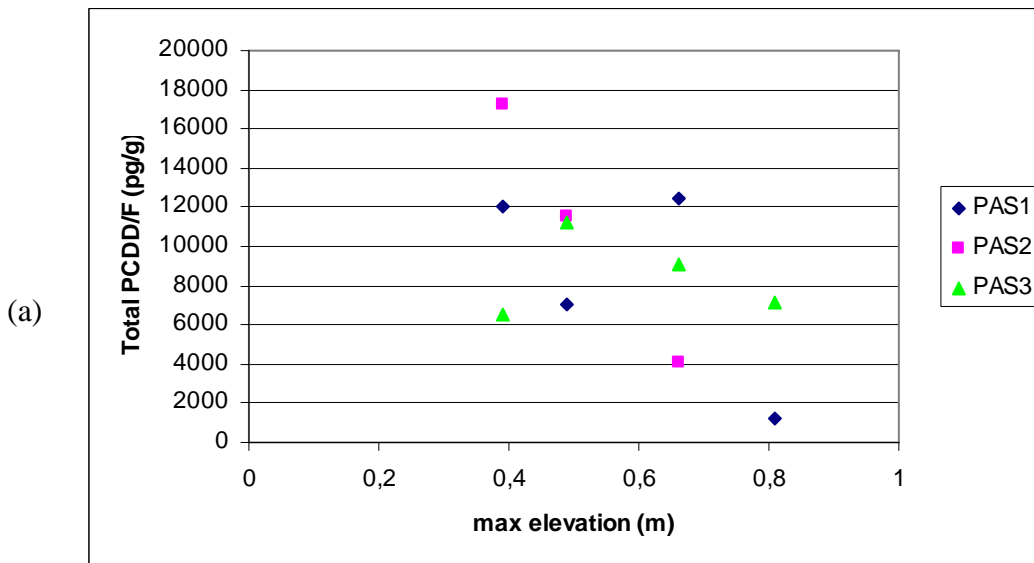
**Figure 22:** (a) SS, (b) DOC and (c) POC measurements at the RWY1 sampling station

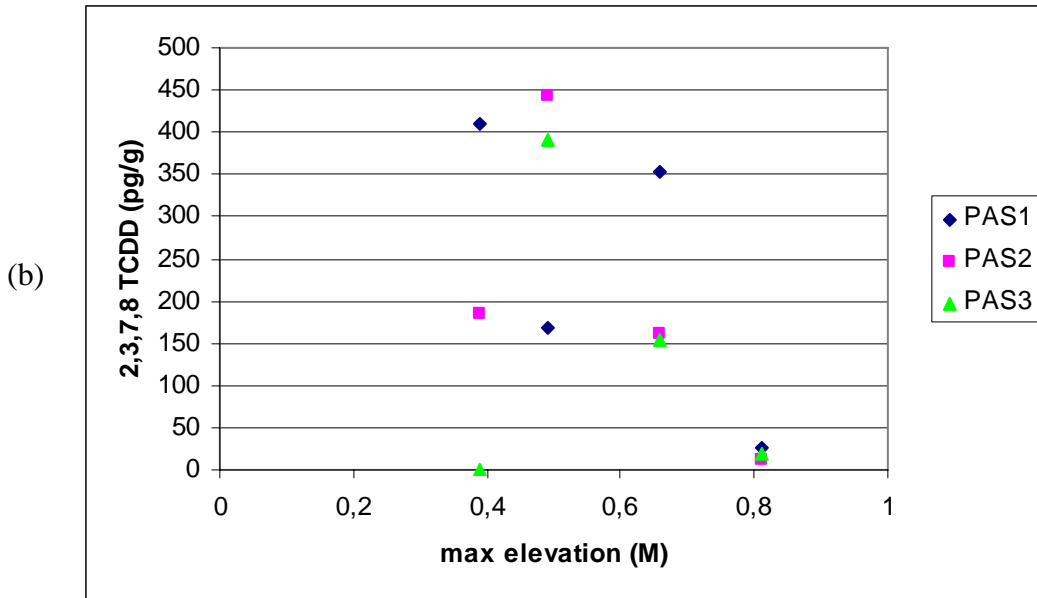
### 4.3 Dependence of Total PCDD/F and 2,3,7,8 TCDD data on the maximum tidal elevation

**Hypothesis:** The concentrations of toxic contaminants (specifically Hg, PCDD/F, and 2,3,7,8-TCDD) are correlated with tidal currents (using maximum tidal height during each sampling event as a proxy).

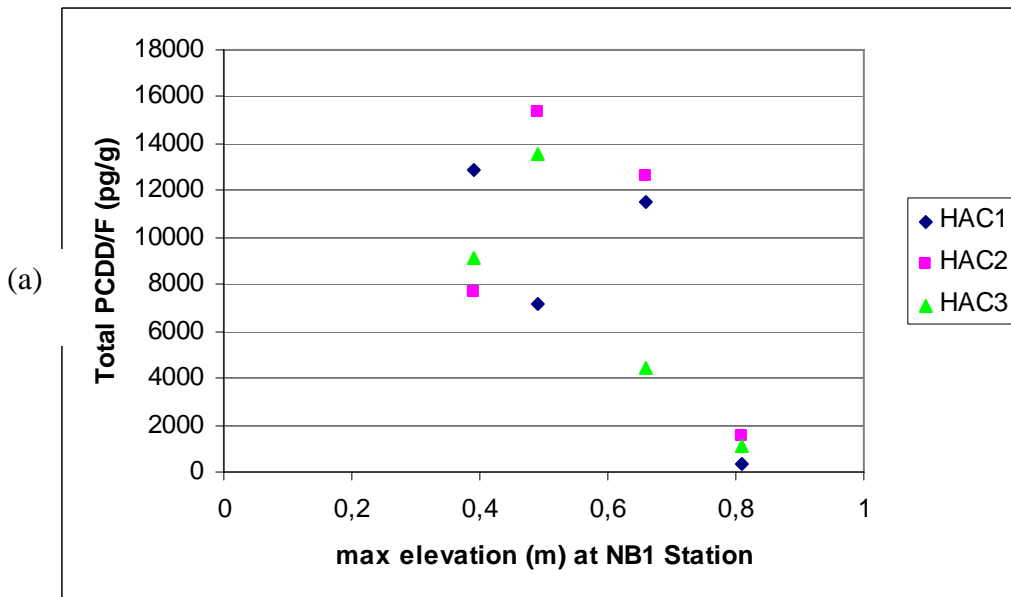
In order to investigate the dependence of the measured total PCDD/F and 2,3,7,8-TCDD concentrations on the magnitude of tidal currents, the total PCDD/F and 2,3,7,8-TCDD concentrations are plotted vs. the maximum tidal elevations in Figure 23 - Figure 26. In the Passaic River, there appears to be a tendency for total PCDD/F concentrations to decrease with higher tidal elevations, except at Station PAS3. This may be due to the upstream location of Station PAS3 and the resulting effects of freshwater discharges to the river. The same general trend is seen along the Hackensack River, although this is largely the result of the low total PCDD/F concentrations observed in the December 2000 samples. Little variability in total PCDD/F concentrations was observed in Newark Bay, again except for low values in December 2000. There does not appear to be any consistent trend in 2,3,7,8-TCDD concentrations in the Passaic and Hackensack Rivers and Newark Bay, although the lowest concentrations at all stations were observed at the highest tidal elevation.

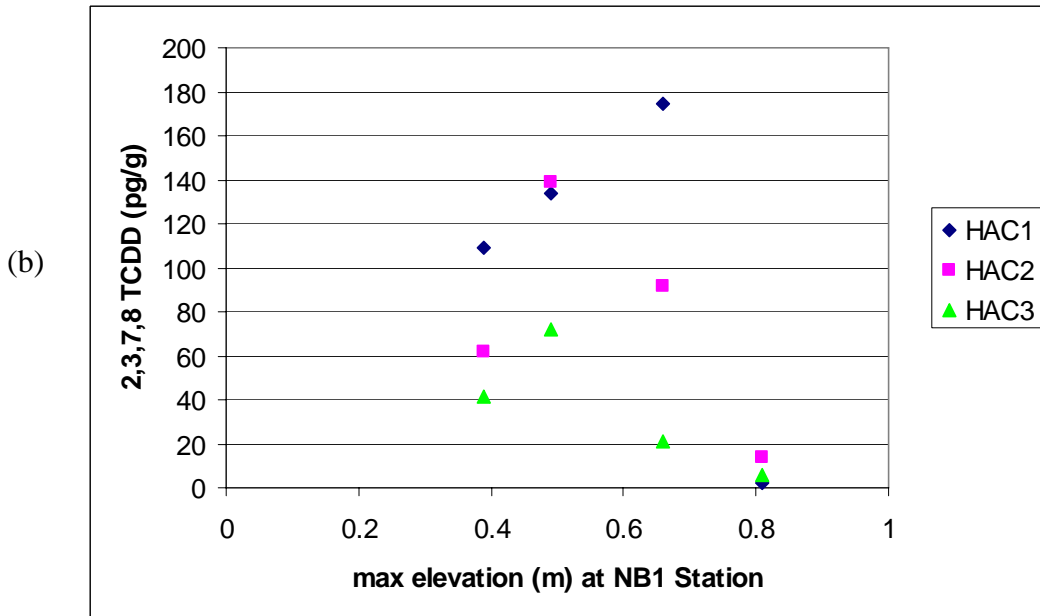
In the Southern Tributaries higher tidal elevations result in slightly higher PCDD/F and 2,3,7,8-TCDD concentrations at the AK1 and RHWY sampling stations, whereas there is no trend for the ELIZ station.



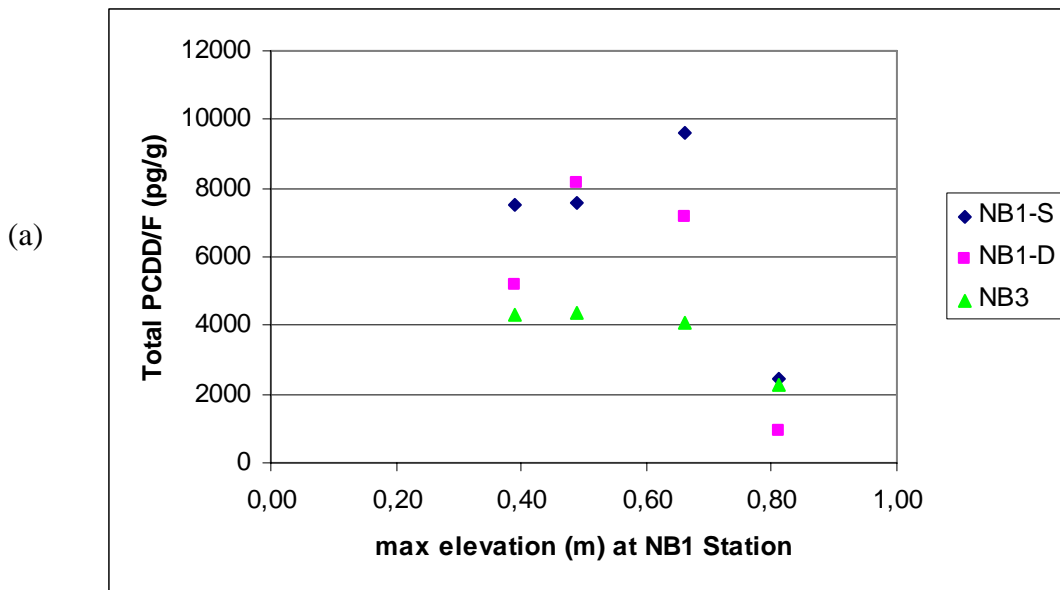


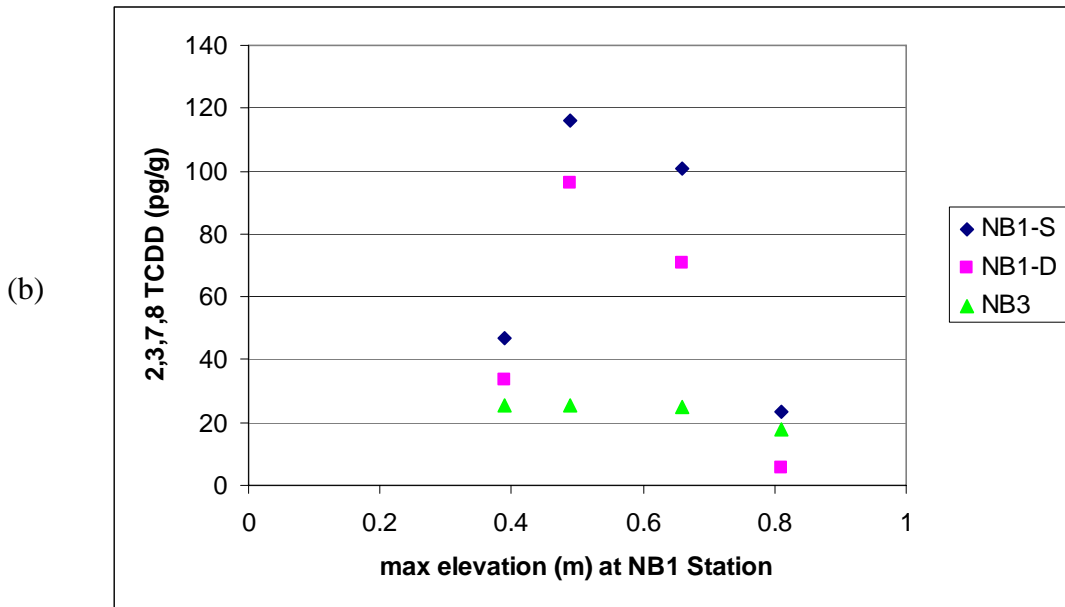
**Figure 23:** (a) Total PCDD/F, and (b) 2,3,7,8 TCDD measurements vs. maximum tidal elevation at the Passaic River sampling stations



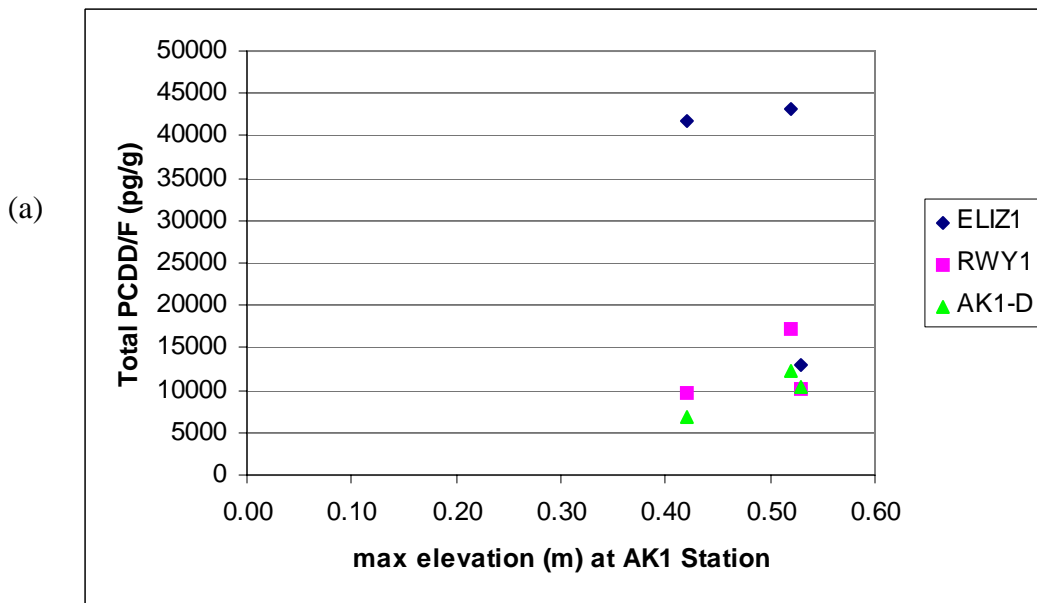


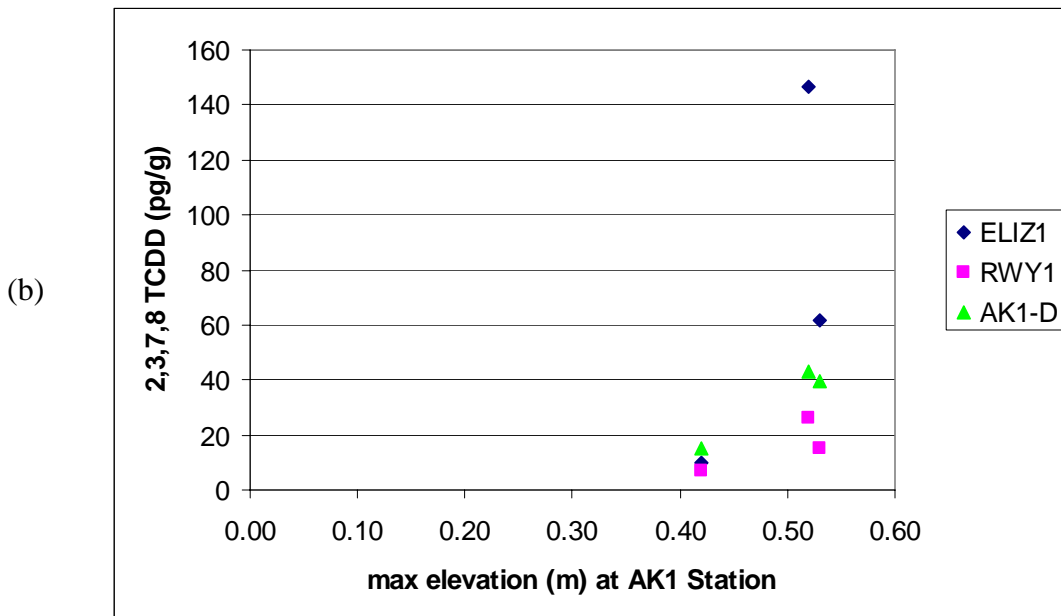
**Figure 24:** (a) Total PCDD/F, and (b) 2,3,7,8 TCDD measurements vs. maximum tidal elevation at the Hackensack River sampling stations





**Figure 25:** (a) Total PCDD/F, and (b) 2,3,7,8 TCDD measurements vs. maximum tidal elevation at the Newark Bay sampling stations





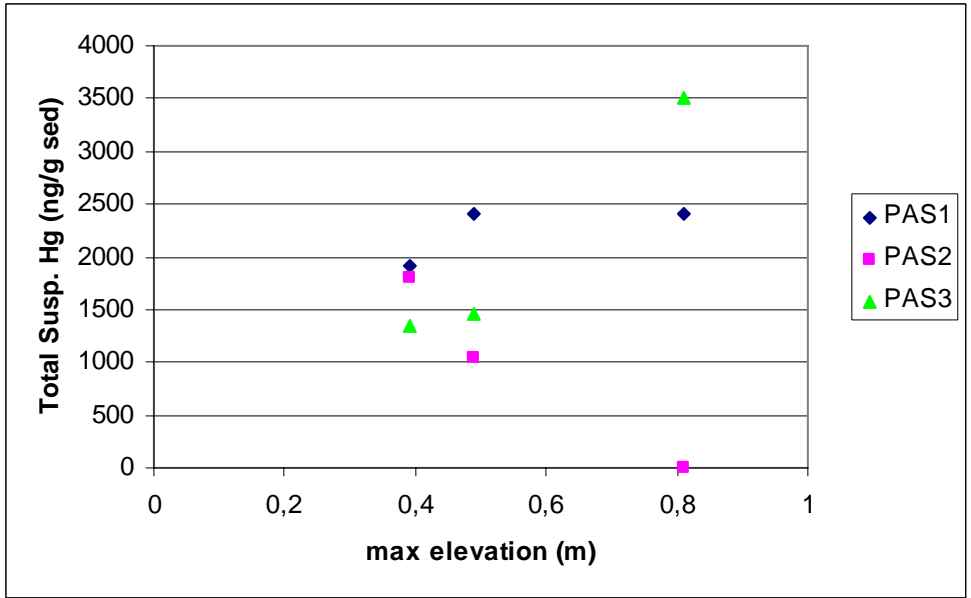
**Figure 26:** (a) Total PCDD/F, and (b) 2,3,7,8 TCDD measurements vs. maximum tidal elevation at the AK1-S, ELIZ, and RWY1 sampling stations

#### 4.4 Dependence of Total Hg on the max tidal elevation

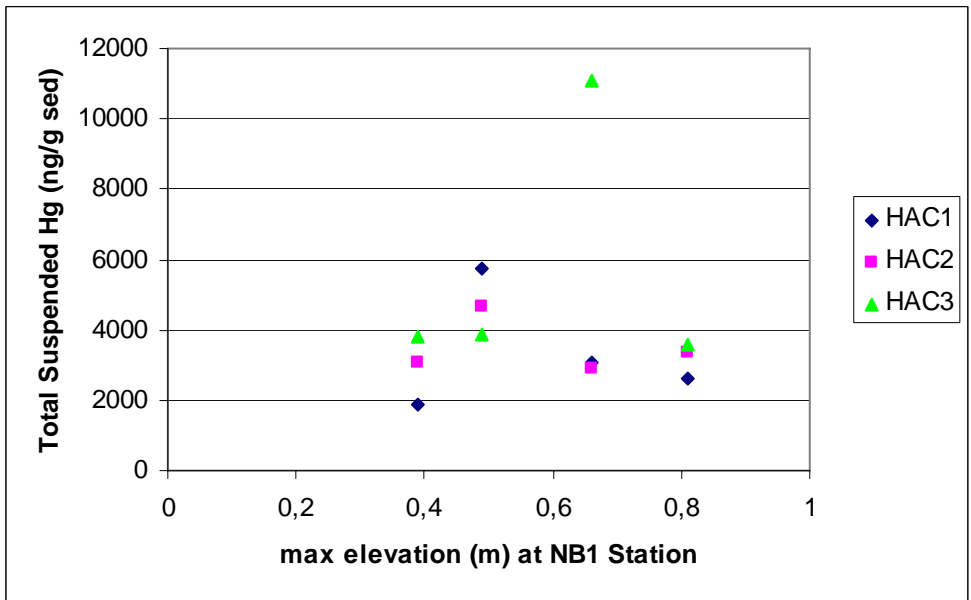
**Hypothesis:** The concentrations of toxic contaminants (specifically Hg, PCDD/F, and 2,3,7,8-TCDD) are correlated with tidal currents (using maximum tidal height during each sampling event as a proxy).

In order to investigate the dependence of the measured total Hg concentrations on the magnitude of tidal currents, the total Hg concentrations in ng/g are plotted vs. the maximum tidal elevations in Figure 27 – Figure 30. No trend is observed along the Passaic and Hackensack River. The Newark Bay stations show higher Total Hg concentrations for higher tidal elevations. In the Southern Tributaries no trend is observed.

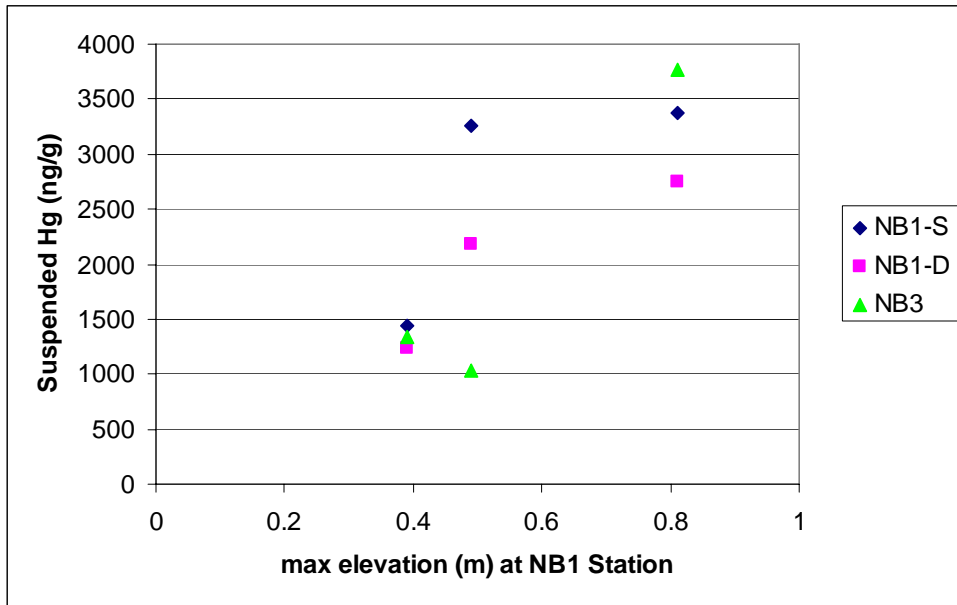




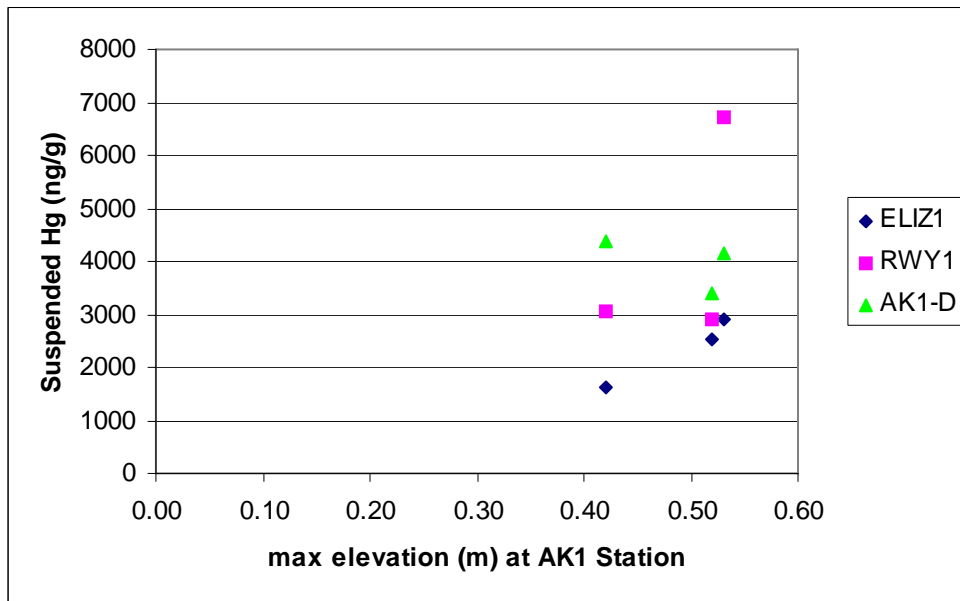
**Figure 27:** Total Suspended Hg (ng/g) measurements vs. maximum tidal elevation at the Passaic River sampling stations



**Figure 28:** Total Suspended Hg (ng/g) measurements vs. maximum tidal elevation at the Hackensack River sampling stations



**Figure 29:** Total Suspended Hg (ng/g) measurements vs. maximum tidal elevation at the Newark Bay sampling stations



**Figure 30:** Total Suspended Hg (ng/g) measurements vs. maximum tidal elevation at the AK1-S, ELIZ, and RWY1 sampling stations

## 5. SUMMARY AND CONCLUSIONS

This study was designed to use the entire NJTRWP Study I-D/E water quality data set in conjunction with selected Study I-E hydrodynamic measurements to evaluate the following hypotheses:

- 1) The concentrations of toxic contaminants (specifically Hg, PCDD/F, and 2,3,7,8-TCDD) are correlated with SS, POC, and DOC levels;
- 2) The observed levels of SS and POC will vary in a consistent manner over the course of the tidal cycle;
- 3) The observed levels of SS and POC will vary in a consistent manner in response to storm/river flow conditions;
- 4) The concentrations of toxic contaminants (specifically Hg, PCDD/F, and 2,3,7,8-TCDD) are correlated with tidal currents (using maximum tidal height during each sampling event as a proxy).

The limited number of water quality samples and the variability in the data did not allow the development of correlation matrices, and limited the scope of the conclusions that could be drawn. However, a qualitative analyses of the data in relation to the above referenced hypotheses provides the following summary and conclusions:

1a) Moderate correlations were found between Total Hg (ng/L) and Total PCDD/F (pg/L) concentrations and SS levels, but the correlations with POC were much weaker.

1b) No correlation was found between Total Hg (ng/g), Total PCDD/F (pg/g), and 2,3,7,8-TCDD (pg/g) and SS or POC.

2a) DOC levels varied little during the course of the tidal cycle during each sampling event at the NJTRWP sampling locations. DOC levels typically ranged between 2 and 6 mgC/L, except in the mid/upper Hackensack River (5.5-9.5 mgC/L).

2b) POC levels varied little during the course of the tidal cycle during each sampling event at the NJTRWP sampling locations. POC levels typically ranged between 0.5 and 2 mgC/L, except in the upper Hackensack River (2-5 mgC/L).

2c) In contrast, SS levels appeared to consistently vary with the tidal cycle at some locations (lower Passaic River, upper Hackensack River, Station NB1-D) but not at others (mid/upper Passaic River, lower/mid Hackensack River, Stations NB1-S and NB3, Elizabeth and Rahway Rivers).

3a) SS, POC, and DOC levels did not appear to vary in a consistent manner with storm/river flow conditions at most of the NJTRWP sampling locations. Exceptions to this are the following –

- Upper Passaic River – SS levels were highest during baseflow conditions;
- Rahway River – SS levels were highest during storm events;
- Elizabeth River – SS, POC, and DOC levels were higher during most storm events.

4a) There does not appear to be any consistent trend in Total Hg concentrations in response to maximum tidal height at the NJTRWP sampling stations, except in Newark Bay (where concentrations increase with tidal height).

4b) Total PCDD/F concentrations appear to vary in response to maximum tidal height at some of the NJTRWP sampling stations, but not at others –

- Concentrations decrease with tidal height in the lower/mid Passaic and Hackensack Rivers;
- Concentrations increase with tidal height in the Rahway River and upper Arthur Kill.

4c) There does not appear to be any consistent trend in 2,3,7,8-TCDD concentrations in response to maximum tidal height at the NJTRWP sampling stations.

In summary, there do not appear to be any overall strong and consistent relationships between contaminant concentrations and physical parameters (SS, POC, and DOC) or hydrodynamic conditions (tidal cycle, storm/river flow conditions, tidal currents). This suggests that contaminant transport and fate is the result of a complex set of interacting factors. However, with additional study, some such relationships may be uncovered in localized areas of the study region, including the following:

- Tidal cycle variations in SS levels in the lower Passaic River, upper Hackensack River, and at depth in Newark Bay;
- Variations in SS levels in response to storm/river flow conditions in the upper Passaic, Elizabeth, and Rahway Rivers;
- Correlations between contaminant concentrations and SS levels.

## Appendix

Pence, A.M., MS. Bruno, A.F. Blumberg, N. Dimou, and K.L. Rankin 2005. Hydrodynamics governing contaminant transport in the Newark Bay Complex. *Proceedings of the Third International Conference on Remediation of Contaminated Sediments*, ISBN:1-57477-150-7, Battelle Press, S.J. Price and R.F Olfebbuttel (eds.).

### Hydrodynamics Governing Contaminant Transport in the Newark Bay Complex

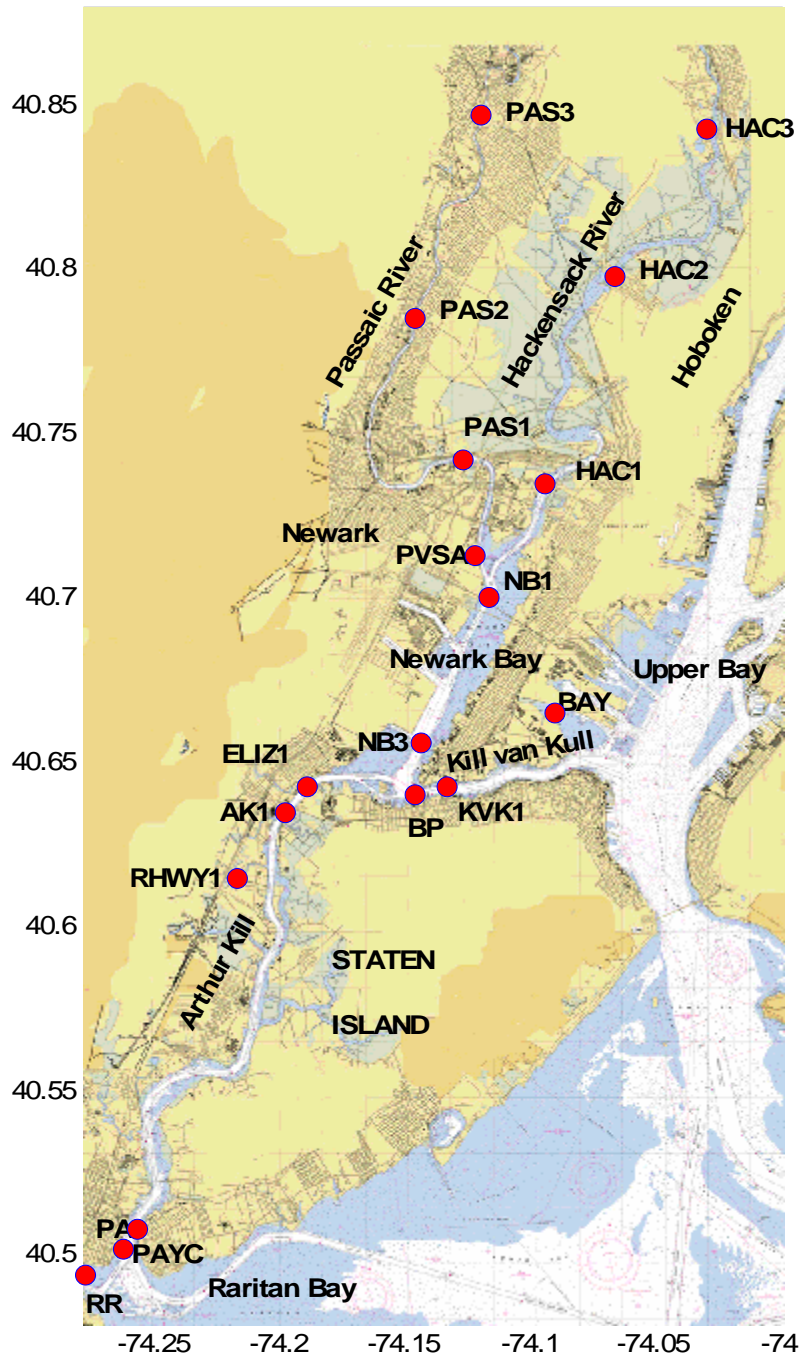
Anne M. Pence, Michael S. Bruno, Alan F. Blumberg,  
Nadia Dimou and Kelly L. Rankin (Stevens Institute of Technology, Hoboken, New Jersey, USA)

**ABSTRACT:** As part of the New Jersey Toxics Reduction Workplan for NY-NJ Harbor, hydrodynamic and water quality surveys were conducted over a 2-year period in the Newark Bay Complex to characterize the circulation and sediment/contaminant transport dynamics in this highly human-altered estuarine system. Because the data collected for this project is not continuous enough in time or space to gain a complete understanding of the system, a three-dimensional hydrodynamic model of the area has been developed using ECOMSED and run for the entire 2-year data collection period. The model has been validated at interior points with the collected data so that conclusions can be made about the circulation pattern trends with confidence. Analyses of the data and model results indicate that flows through the Newark Bay Complex respond to an intricate combination of forcing influences, but are strongly coupled with meteorological events. This understanding is being used to determine the pathways of the contaminants that exist in the area by studying time series of suspended solids, carbon, total mercury and 2,3,7,8 TCDD (the most toxic PCDD/F congener) in conjunction with time series of hydrodynamic quantities. It is hoped that these findings will aid in a comprehensive cleanup plan for Newark Bay and the Passaic River.

#### INTRODUCTION:

Hydrodynamic and water quality surveys were conducted from the year 2000-2002 to determine the relationship between hydrodynamic forcing and contaminant transport pathways within the estuary in the Newark Bay Complex (Figure 1) as part of the New Jersey Toxics Reduction Workplan for NY-NJ Harbor. Hydrodynamic data were collected at various stations within this region between 2000 and 2002, with measurements that included current profiles, salinity and temperature measurements, water level measurements, and water and suspended sediment quality measurements. A three-dimensional hydrodynamic model was developed using ECOMSED, a version of the Princeton Ocean Model, to fill in the spatial and temporal data gaps which made system analysis difficult.

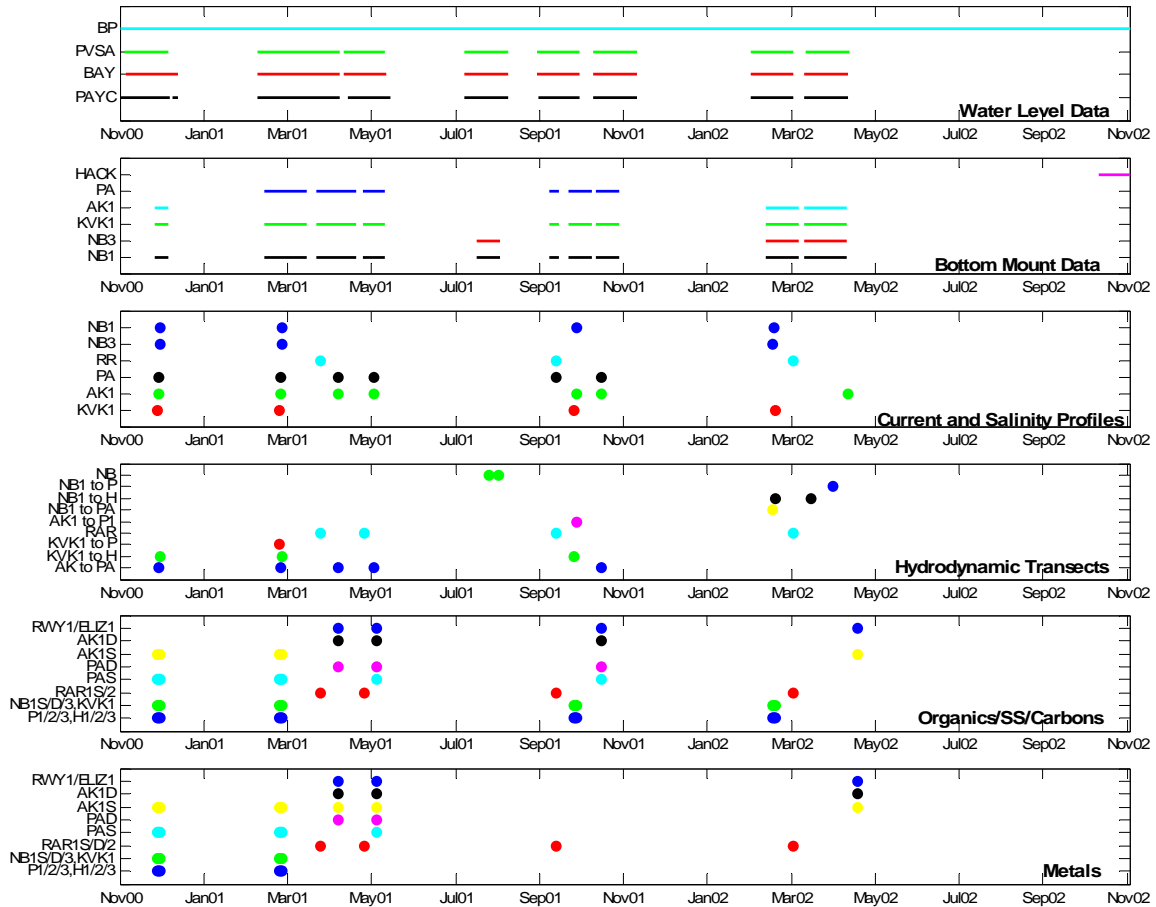
**Site Description.** The Newark Bay Complex consists of two freshwater inputs from the north, the Passaic and Hackensack Rivers, and two tidal straits. These straits are the Kill van Kull, which connects Newark Bay to Upper New York Harbor, and the Arthur Kill, which joins Newark Bay to Raritan Bay. A 40-foot deep shipping channel ran the length of Newark Bay at the time of sampling (the channel has since been deepened.)



**FIGURE 2.** Newark Bay Complex study area. Dots indicate hydrodynamic and water quality stations described in the Materials and Methods Section.

## MATERIALS AND METHODS:

Figure 2 shows an inventory of the hydrodynamic data that was collected during the 2000-2002 time frame, with six panels that show the different types of data that were collected. The top panel shows the water level data available from the acoustic tide gauges

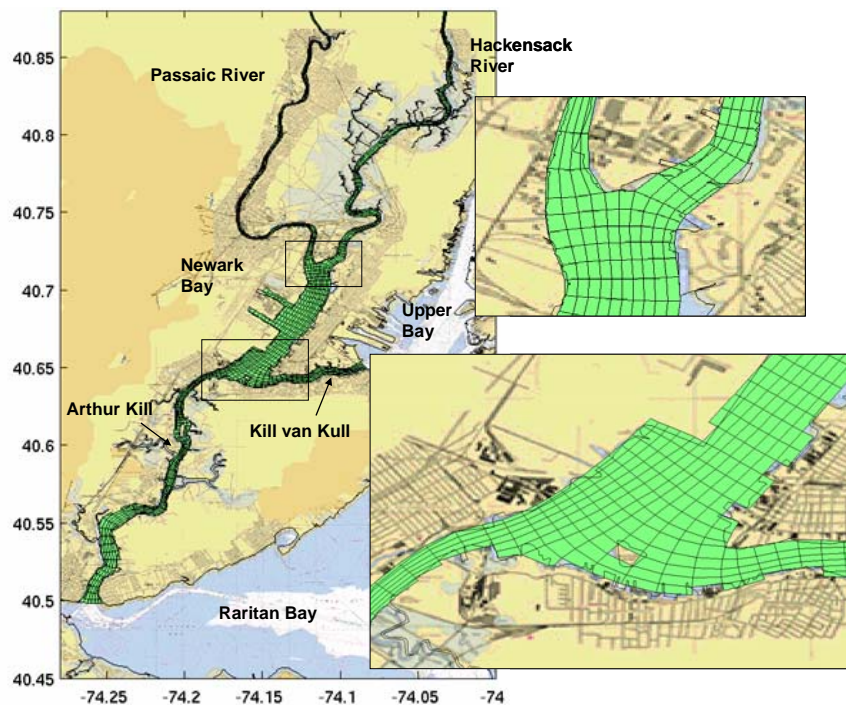


**FIGURE 3. Hydrodynamic CARP Data Inventory for 2000-2002 for water level data (panel 1), bottom mount data (panel 2), moored vessel profile data (panel 3) and hydrodynamic transect data (panel 4).**

located at Passaic Valley Sewerage Authority (PVSA), Constable Hook in Bayonne (BAY), and Perth Amboy Yacht Club (PAYC), and the NOAA/NOS tide station at Bergen Point (BP). These locations can be viewed on the bathymetric map in Figure 1. The panel below this displays the bottom mount data that is available from the Hackensack River (HACK), Perth Amboy (PA), the north end of the Arthur Kill (AK1), the western end of the Kill van Kull (KVK1), the north end of Newark Bay (NB1), and at the south end of Newark Bay (NB3). Measurements collected from the bottom mounts included water level from a pressure sensor, current profiles using an acoustic Doppler current profiler (ADP), bottom salinity using a conductivity-temperature-depth sensor (CTD), and turbidity using an optical backscatter sensor (OBS). The third panel down shows the current and salinity profiles made from the moored vessels using CTDs and ADPs. These locations are the same as described for the bottom mounts, with an

additional location in the Raritan River (RR), which feeds into Raritan Bay south of Perth Amboy. The fourth panel represents the salinity and current data collected during vessel transects using ADPs and CTDs. The bottom two panels represent the water quality data that was collected using Trace Organic Platform Samplers (TOPS) and grab sampling techniques.

Because the data collected for this project is not continuous enough in time or space to gain a complete understanding of the system, a high-resolution, three-dimensional hydrodynamic model of the area using ECOMSED was developed, with the model domain and bathymetry shown in Figure 2. The model is driven along two open boundaries; one is along the south end of the Arthur Kill where it joins Raritan Bay, and one is along the eastern end of the Kill van Kull, where it joins Upper New York Bay. Hourly water elevations are specified for each of the boundaries, which include tidal elevation as well as remote water level effects. The elevation data was taken from two water level gages located near the two boundaries, with interpolated values from the NOAA operated Bergen Point Station for periods when these gages were not operational. Temperature and salinity are also indicated along the boundaries, using salinity data collected from CTDs on the bottom mounts. Hourly freshwater inflows are specified at 12 locations within the model area, and directional wind speed is specified hourly with data from the Bergen Point NOAA meteorological station. Model output compares well with data, with mean correlation coefficients ( $r^2$ ) in Newark Bay of 0.96 for elevation, 0.82 for salinity, and 0.88 for depth-averaged along-channel velocity.



**FIGURE 4. High resolution model grid for Newark Bay Complex.**



## RESULTS AND DISCUSSION:

Figures 3 and 4 show four panels which display 34-hour low-passed model output from December 2000 and March 2001, respectively, where everything with a period of occurrence of less than 34 hours was removed. The top panel shows the wind velocity and direction, where the arrow shows direction the wind is going to, and the arrow's position along the y-axis denotes speed (m/s). The second panel shows the elevation change in time ( $d\eta/dt$ ) in m/s. The area and mean depth in Newark Bay remain the same over time; only the surface elevation ( $\eta$ ) is changing. So, the change of elevation in time represents the volume flux into and out of Newark Bay.

When wind blows across the open ocean, the water surface flows to the right of the wind direction in the Northern Hemisphere due to the Coriolis force. Water at levels below the surface flow to the right as well, though not as quickly as the surface layer. The net effect is that the mass transport of water is at a ninety degree angle to the wind, (Ekman transport). Ekman transport due to strong winds from the west in the Newark Bay region will move water offshore. This causes a lowering the sea level in the coastal ocean, which sets up a gradient between the water level in Newark Bay and the coastal ocean and causes water to flow out of the Bay. A wind event from the west that begins approximately December 17, 2000, results in volume flux out of Newark Bay, and a lowering of residual elevation. Conversely, strong wind events from the east will cause a rise in water level in the coastal ocean. An example of this is a wind event that begins approximately March 21, 2001, which results in volume flux into Newark Bay, and an ensuing increase in residual elevation. These events have been previously observed by Chant, et. al., (2001), Rankin, et. al., (2002), and Pence, et. al., (2003).

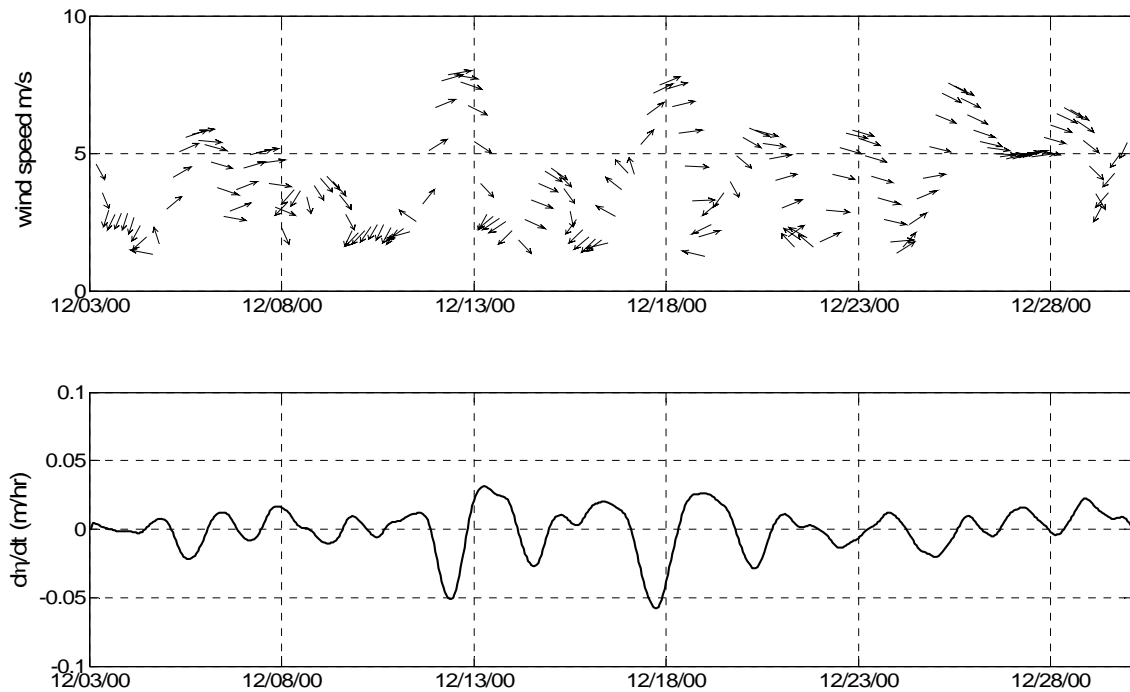
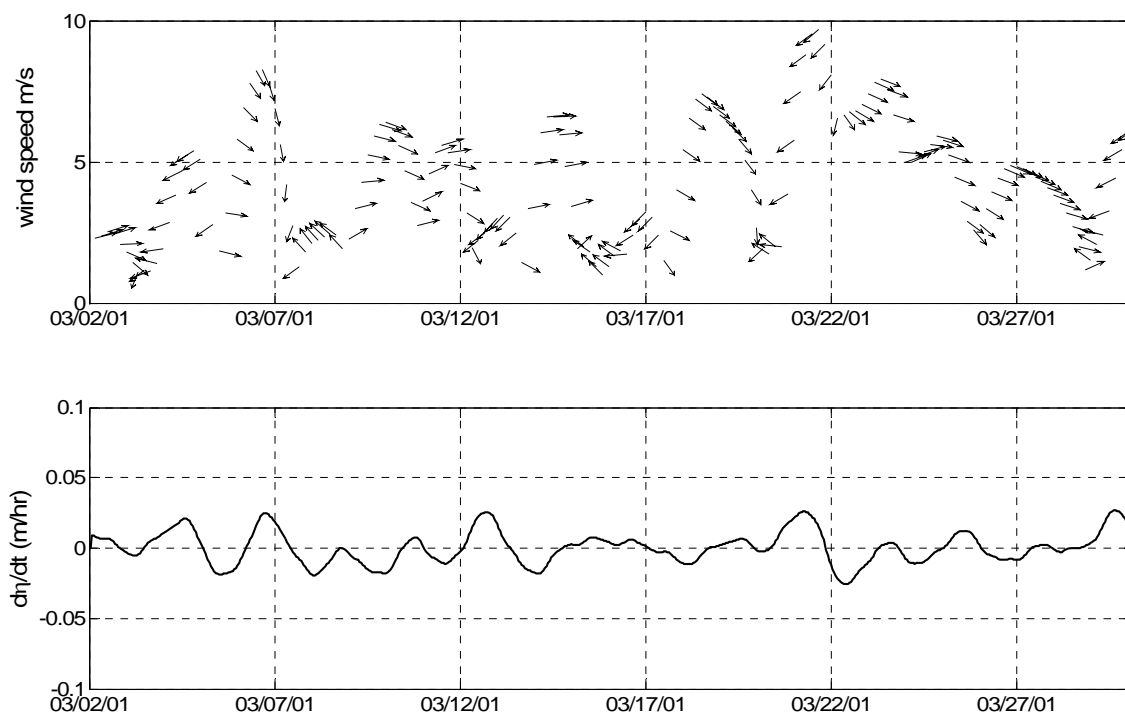


FIGURE 5. Low-passed wind and change in water level for December 2000



**FIGURE 6. Low-passed wind and change in water level for March 2001.**

Hydrodynamic events such as these flushing events can have a noticeable effect on contaminant and sediment transport. Table 1 shows the levels of suspended solids (SS), dissolved organic carbon (DOC), particulate organic carbon (POC), total mercury (Hg), total dioxins and furans (PCDD/F), and the most toxic PCDD/F congener, TCDD 2,3,7,8, for all TOPS sampling periods at stations NB1, KVK1 and AK1. Also included in the table are the stage of tide, maximum daily river flow, and type of flushing event, if any. The TOPS sampling periods could last from 4 to 7 hours, so some tide stages were transitional. Station “-D” denotes water samples taken at a depth of 1.5 m (5 ft) from the bottom, and “-S” samples were taken 1.5 m (5 ft) below the surface. Comparing the quantities shown in Table 1 is a method of interpreting the relationship between hydrodynamics and contaminant levels. For example, the highest concentration of dioxins/furans at NB1 occurred on October 19, 2001, which is 2 days after an emptying event. The higher concentrations could be the result of water or sediment from the Passaic River (which is a major source of dioxin) that entered Newark Bay during the event. Also, the highest concentration of dioxins/furans at KVK1 occurred during the largest freshwater flows on March 13, 2001. This type of analysis will continue in further efforts to understand the effects of hydrodynamic events on contaminant transport.

Station IDs Sampled	Date Sampled	Stage of Tidal Velocity	Max Daily River Flow (m <sup>3</sup> /s)	Flushing Event Type	SS Geom. Mean (mg/L)	DOC Geom. Mean (mg/L)	POC Geom. Mean (mg/L)	Total Hg (ng/L)	Total PCDD/F (ng/L)	Total 2,3,7,8 TCDD (ng/g)
KVK1	12/13/00	ebb	150	filling	12.8	2.8	0.7	28.8	22.6	11.4
AK1-S	12/14/00	slack to ebb	520	none	14.9	2.8	0.7	77.5	77.7	12.2
NB1-D	12/15/00	ebb	780	none	18.7	2.1	0.9	38.4	15.6	5.8
NB1-S	12/15/00				13.7	2.9	1.1	23.6	27.4	23.4
NB3	12/15/00				6.5	2.5	0.5	19.2	13.8	17.8
KVK1	03/13/01	ebb	1640	none	10.5	4.8	0.3	18.4	59.5	33.0
AK1-S	03/14/01	flood to ebb	1940	none	10.8	3.8	0.4	17.2	77.7	26.5
NB1-D	03/15/01	slack to ebb	1970	none	9.6	3.6	0.4	18.6	47.2	33.7
NB1-S	03/15/01				6.5	4.4	0.7	10.8	46.1	46.7
NB3	03/15/01				8.6	4.2	0.3	11.9	35.1	25.6
AK1-D	04/25/01	flood to ebb	900	filling	8.2	2.8	0.5	23.4	98.7	42.9
AK1-D	05/22/01	slack to ebb	370	none	9.0	2.7	0.5	45.3	56.6	14.9
KVK1	10/17/01	ebb to slack	170	emptying	15.4	3.0	0.4	13.7	50.3	15.2
NB1-D	10/19/01	ebb	120	none	13.8	3.5	0.3	17.7	106.4	96.4
NB1-S	10/19/01				21.1	4.3	0.3	21.8	137.2	116.2
NB3	10/19/01				9.7	3.9	0.3	19.6	41.1	25.7
AK1-D	11/06/01	flood to slack	150	filling	6.1	2.5	0.2	45.3	61.1	39.3
NB1-D	03/13/02	ebb	30	none	6.2	2.7	0.7	NA	43.1	71.0
NB1-S	03/13/02				4.5	5.2	0.7	NA	40.7	100.8
NB3	03/13/02				5.3	2.2	0.6	NA	21.2	24.8
KVK1	03/14/02	ebb	35	none	8.3	2.4	0.4	11.4	40.0	24.5

**TABLE 4. Hydrodynamic Characteristics and Contaminant Levels during TOPS sampling periods.**

**ACKNOWLEDGEMENTS:**

Funding for this study was provided by the New Jersey Department of Environmental Protection under contract number SR04-068. The authors thank Joel Pecchioli for his insightful comments.

**REFERENCES:**

Chant, R., Glenn, S., Hunter, E., Rankin, K., Bruno, M., Styles, R., and Hires, R. 2001. "Circulation and mixing in a complex estuarine environment." *Poster presented at Society of Environmental Toxicology and Chemistry 22<sup>nd</sup> Annual Meeting, Baltimore, Maryland.*

Pence, A., Rankin, K., Bruno, M., Fullerton, B., and Burke, P. 2003. "Meteorological forcing of the Newark Bay/Kills system." *Presented at 17th Biennial Conference of the Estuarine Research Federation, Seattle, Washington.*

Rankin, K., Chant, R., Bruno, M., and Glenn, S. 2002. "Meteorological forcing of the Kills in New York Harbor." *In EOS Transactions, American Geophysical Union.*